

Features

- Very High Slew Rate 600V/ μ s
- Open Loop Gain 30kV/V
- Wide Gain-Bandwidth ($A_v \geq 10$) 600MHz
- Power Bandwidth 9.5MHz
- Low Offset Voltage 8mV
- Input Voltage Noise 6nV/ $\sqrt{\text{Hz}}$
- Output Voltage Swing $\pm 10\text{V}$
- Monolithic Bipolar Dielectric Isolation Construction

Description

The Harris HA-2539 represents the ultimate in high slew rate, wideband, monolithic operational amplifiers. It has been designed and constructed with the Harris High Frequency Bipolar Dielectric Isolation process and features dynamic parameters never before available from a truly differential device.

With a 600V/ μ s slew rate and a 600MHz gain bandwidth product, the HA-2539 is ideally suited for use in video and RF amplifier designs, in closed loop gains of 10 or greater. Full $\pm 10\text{V}$ swing coupled with outstanding A.C. parameters and complemented by high open loop gain makes the devices useful in high speed data acquisition systems.

Applications

- Pulse and Video Amplifiers
- Wideband Amplifiers
- High Speed Sample-Hold Circuits
- RF Oscillators

The HA-2539 is available in 14 pin ceramic and plastic DIP. The HA-2539-2 operates over -55°C to $+125^\circ\text{C}$ temperature range while the HA-2539-5 and HA-2539C-5 operates over the 0°C to $+75^\circ\text{C}$ range.

For further design assistance please refer to Application Note 541 (Using The HA-2539 Very High Slew Rate Wideband Operational Amplifiers) and Application Note 556 (Thermal Safe-Operating-Areas For High Current Operational Amplifiers).

For military grade product information, the HA-2539/883 data sheet is available upon request.

Pinout

HA1-2539/2539C (CERAMIC DIP)
HA3-2539/2539C (PLASTIC DIP)
TOP VIEW

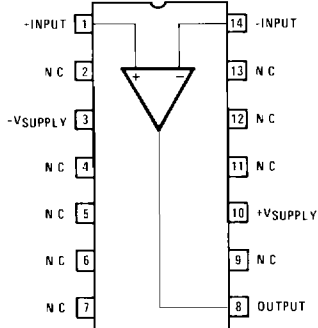

(N.C.) No Connection pins may be tied to a ground plane for better isolation and heat dissipation

Schematic

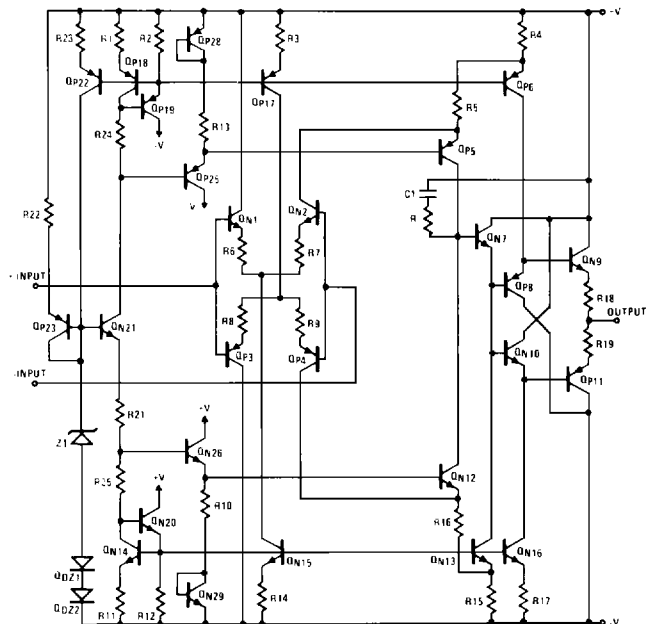

Specifications HA-2539

HA-2539

Absolute Maximum Ratings (Note 1)

Voltage Between V+ and V- Terminals.....	35V
Differential Voltage.....	±6V
Peak Output Current.....	50mA
Continuous Output Current.....	33mA _{RMS}
Internal Quiescent Power Dissipation (Note 2)....	870mW (Ceramic DIP)

Operating Temperature Range

HA-2539-2.....	-55°C ≤ T _A ≤ +125°C
HA-2539/2539C-5.....	0°C ≤ T _A ≤ +75°C
Storage Temperature Range.....	-65°C ≤ T _A ≤ +150°C
Maximum Junction Temperature.....	+175°C

Electrical Specifications V_{SUPPLY} = ±15V, R_L = 1kΩ, C_L ≤ 10pF, Unless Otherwise Specified.

PARAMETER	TEMP	HA-2539-2 -55°C to +125°C			HA-2539-5 0°C to +75°C			HA-2539C-5 0°C to +75°C			UNITS
		MIN	TYP	MAX	MIN	TYP	MAX	MIN	TYP	MAX	
INPUT CHARACTERISTICS											
Offset: Voltage	+25°C	—	8	10	—	8	15	—	8	15	mV
	Full	—	13	15	—	13	20	—	13	20	mV
Average Offset Voltage Drift	Full	—	20	—	—	20	—	—	20	—	μV/°C
Bias Current	+25°C	—	5	20	—	5	20	—	5	20	μA
	Full	—	—	25	—	—	25	—	—	25	μA
Offset: Current	+25°C	—	1	6	—	1	6	—	1	6	μA
	Full	—	—	8	—	—	8	—	—	8	μA
Input Resistance	+25°C	—	10	—	—	10	—	—	10	—	kΩ
Input Capacitance	+25°C	—	1	—	—	1	—	—	1	—	pF
Common Mode Range	Full	±10	—	—	±10	—	—	±10	—	—	V
Input Current Noise (f = 1KHz, R _{SOURCE} = 0Ω)	+25°C	—	6	—	—	6	—	—	6	—	pA/√Hz
Input Voltage Noise (f = 1KHz, R _{SOURCES} = 0Ω)	+25°C	—	6	—	—	6	—	—	6	—	nV/√Hz
TRANSFER CHARACTERISTICS											
Large Signal Voltage Gain (Note 3)	+25°C	10K	15K	—	10K	15K	—	7K	10K	—	V/V
	Full	5K	—	—	5K	—	—	5K	—	—	V/V
Common-Mode Rejection Ratio (Note 4)	Full	60	72	—	60	72	—	60	72	—	dB
Minimum Stable Gain	+25°C	10	—	—	10	—	—	10	—	—	V/V
Gain Bandwidth Product (Notes 5 & 6)	+25°C	—	600	—	—	600	—	—	600	—	MHz
OUTPUT CHARACTERISTICS											
Output Voltage Swing (Note 3, 10)	Full	±10	—	—	±10	—	—	±10	—	—	V
Output Current (Note 3)	+25°C	±10	±20	—	±10	±20	—	±10	±20	—	mA
Output Resistance	+25°C	—	30	—	—	30	—	—	30	—	Ω
Full Power Bandwidth (Notes 3 & 7)	+25°C	8.7	9.5	—	8.7	9.5	—	8.7	9.5	—	MHz
TRANSIENT RESPONSE (Note 8)											
Rise Time	+25°C	—	7	—	—	7	—	—	7	—	ns
Overshoot	+25°C	—	15	—	—	15	—	—	15	—	%
Slew Rate	+25°C	550	600	—	550	600	—	550	600	—	V/μs
Settling Time: 10V Step to 0.1%	+25°C	—	180	—	—	180	—	—	200	—	ns
POWER REQUIREMENTS											
Supply Current	Full	—	20	25	—	20	25	—	20	25	mA
Power Supply Rejection Ratio (Note 9)	Full	60	70	—	60	70	—	60	70	—	dB

2

OP AMPS & COMPARATORS

NOTES:

1. Absolute maximum ratings are limiting values, applied individually, beyond which the serviceability of the circuit may be impaired. Functional operability under any of these conditions is not necessarily implied.
2. This value assumes a no load condition. Maximum power dissipation with load conditions must be designed to maintain the maximum junction temperature below +175°C. By using Application Note 556 on Safe Operating Area equations, along with the packaging thermal resistances listed in the die information section, proper load conditions can be determined. Heat sinking is recommended above +75°C with suggested models:
Thermalloy #6007 ($\theta_{SA} = 40^\circ\text{C/W}$) or AAVID #5602B ($\theta_{SA} = 16^\circ\text{C/W}$).
3. $R_L = 1\text{k}\Omega$, $V_O = \pm 10\text{V}$
4. $V_{CM} = \pm 10\text{V}$
5. $V_O = 90\text{mV}$
6. $A_V = 10$.
7. Full Power Bandwidth guaranteed based on slew rate measurement using $\text{FPBW} = \frac{\text{Slew Rate}}{2\pi V_{PEAK}}$
8. Refer to Test Circuits section of data sheet.
9. $V_{S\text{UPPLY}} = \pm 5\text{VDC}$ to $\pm 15\text{VDC}$
10. Guaranteed range for output voltage is $\pm 10\text{V}$. Functional operation outside of this range is not guaranteed.

Test Circuits

TEST CIRCUIT

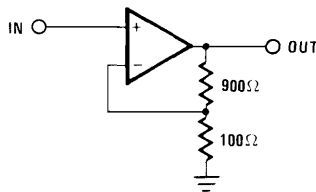

$V_S = \pm 15\text{V}$
 $A_V = +10$
 $C_L \leq 10\text{pF}$

LARGE SIGNAL RESPONSE

Vertical Scale: A = 0.5V/Div., B = 5.0V/Div.
 Horizontal Scale: Time: 50ns/Div.

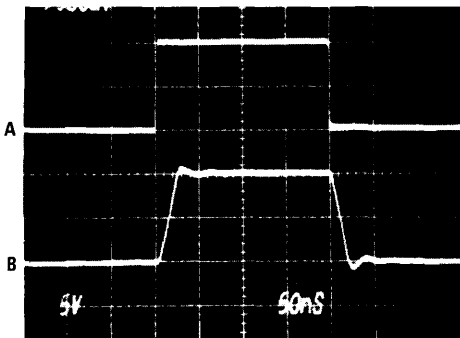

SMALL SIGNAL RESPONSE

Vertical Scale: Input = 10mV/Div., Output = 50mV/Div.
 Horizontal Scale: 20ns/Div.

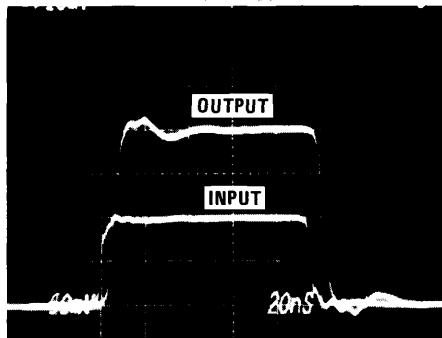

SETTLING TIME TEST CIRCUIT

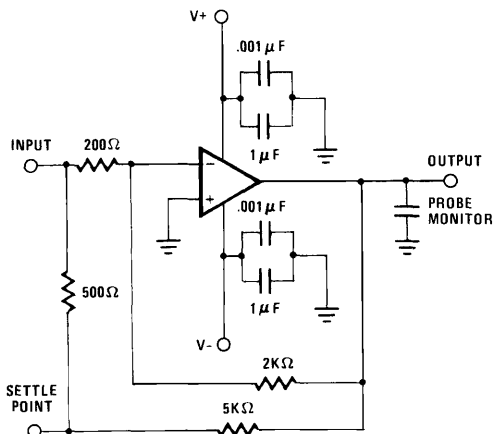

- $A_V = -10$
- Load Capacitance should be less than 10pF.
- It is recommended that resistors be carbon composition and that feedback and summing network ratios be matched to 0.1%.
- SETTLE POINT (Summing Node) capacitance should be less than 10pF. For optimum settling time results, it is recommended that the test circuit be constructed directly onto the device pins. A Tektronix 568 Sampling Oscilloscope with S-3A sampling heads is recommended as a settle point monitor.

Typical Performance Curves

INPUT OFFSET VOLTAGE AND BIAS CURRENT vs. TEMPERATURE

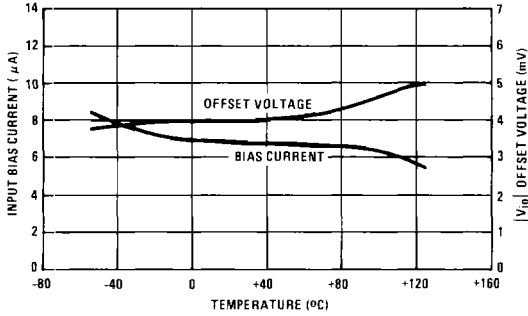

INPUT NOISE VOLTAGE AND NOISE CURRENT vs. FREQUENCY

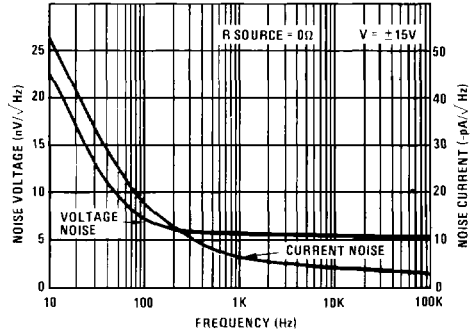

BROADBAND NOISE (0.1Hz to 1MHz)

Vertical Scale: $10\mu V/Div.$
Horizontal Scale: 50ms/Div.

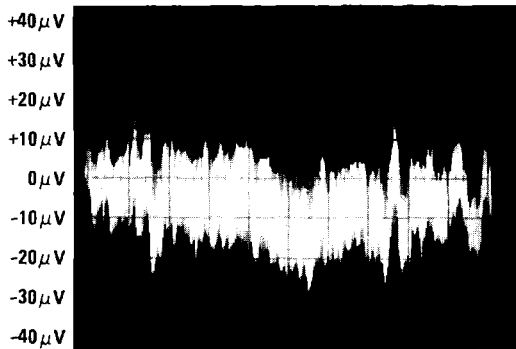

COMMON MODE REJECTION RATIO vs. FREQUENCY

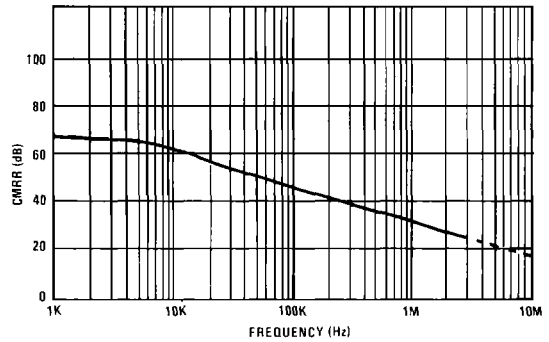

POWER SUPPLY REJECTION RATIO vs. FREQUENCY

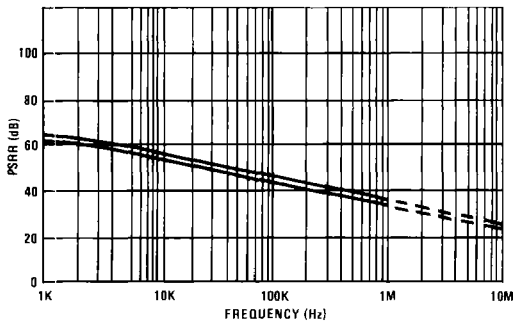

OPEN LOOP GAIN/PHASE vs. FREQUENCY HA-2539

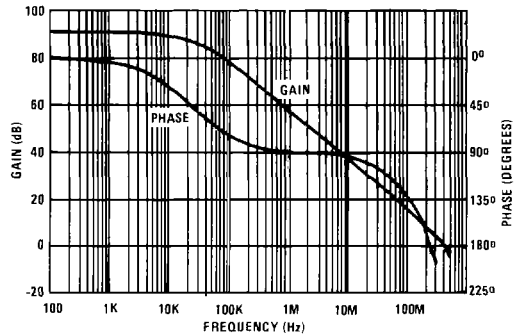

Typical Performance Curves (Continued)

CLOSED LOOP FREQUENCY RESPONSE FOR VARIOUS CLOSED LOOP GAINS

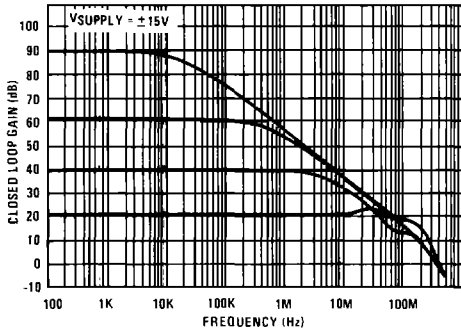

OUTPUT VOLTAGE SWING vs. FREQUENCY

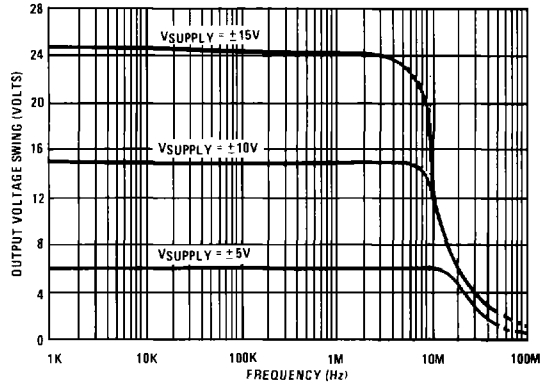

OUTPUT VOLTAGE SWING vs. LOAD RESISTANCE

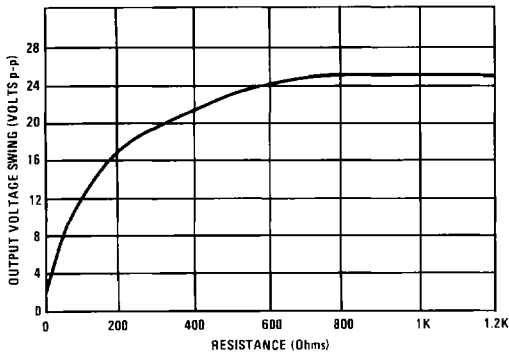

NORMALIZED AC PARAMETERS vs. TEMPERATURE

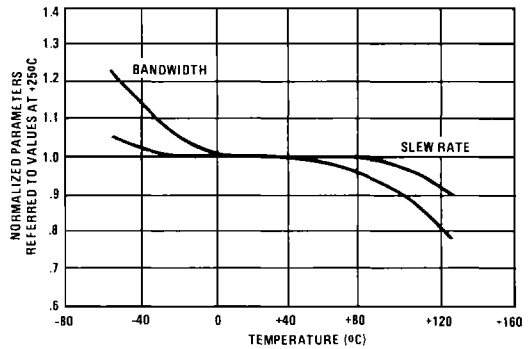

SETTLING TIME FOR VARIOUS OUTPUT STEP VOLTAGES

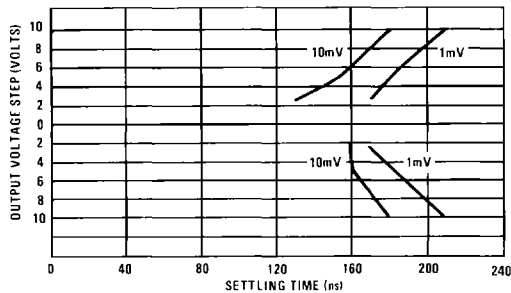

POWER SUPPLY CURRENT vs. TEMPERATURE AND SUPPLY VOLTAGE

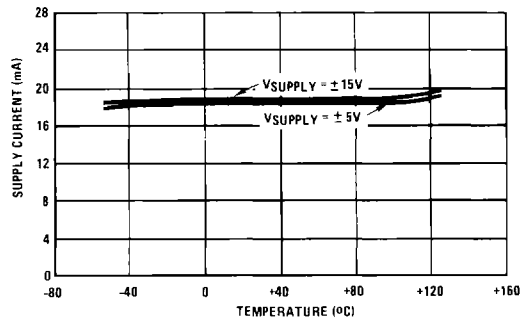

Applications

**FREQUENCY COMPENSATION
COMPENSATION BY OVERDAMPING**

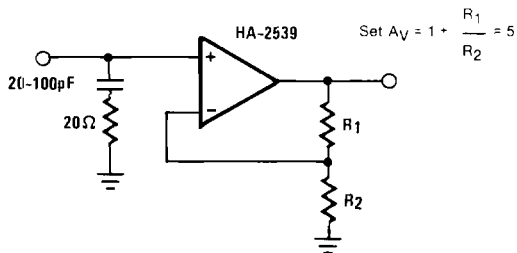

STABILIZATION USING Z_{IN}

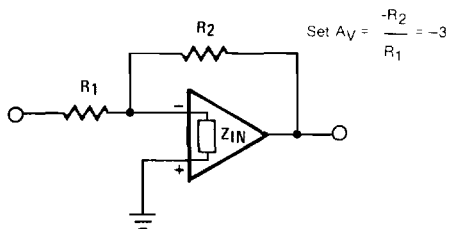

**REDUCING DC ERRORS
COMPOSITE AMPLIFIER**

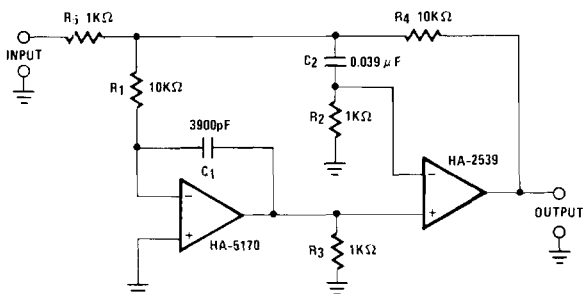

NOTE: No connect pins (NC) on the HA-2539 should be tied to a ground plane.
Refer to Figure 4 in Application Note 541 for detailed Application suggestions.

**DIFFERENTIAL GAIN ERROR (3%)
HA-2539 20dB VIDEO GAIN BLOCK**

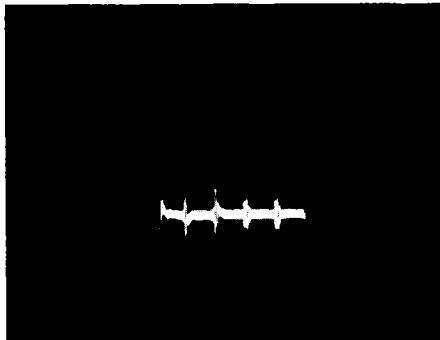

Die Characteristics

Transistor Count	30	
Die Dimensions	75 x 61 x 19 mils (1910μm x 1550μm x 483μm)	
Substrate Potential (Powered Up)*	V-	
Process	High Frequency Bipolar-DI	
Passivation	Nitride	
Thermal Constants (°C/W)	θ_{ja}	θ_{jc}
HA1-2539/2539C Ceramic DIP	104	48
HA3-2539/2539C Plastic DIP	95	46

*The substrate may be left floating (Insulating Die Mount) or it may be mounted on a conductor at V- potential.