



Photocoupler
Product Data Sheet
LTV-155E

Spec No. :DS70-2013-0016
Effective Date: 09/22/2022
Revision: D

LITE-ON DCC

RELEASE

BNS-OD-FC001/A4

Photocoupler LTV-155E series

1.0 Amp Output Current IGBT Gate Drive Optocoupler with Rail-to-Rail Output Voltage, High CMR.

1. DESCRIPTION

The LTV-155E optocoupler is ideally suited for driving power IGBTs and MOSFETs used in motor control inverter applications and inverters in power supply system. It contains an AlGaAs LED optically coupled to an integrated circuit with a power output stage. The 1.0A peak output current is capable of directly driving most IGBTs with ratings up to 1200 V/50 A. For IGBTs with higher ratings, the LTV-155E series can be used to drive a discrete power stage which drives the IGBT gate.

The Optocoupler operational parameters are guaranteed over the temperature range from -40°C ~ +105°C.

1.1 Features

- 1.0 A maximum peak output current
- 0.8 A minimum peak output current
- Rail-to-rail output voltage
- 200 ns maximum propagation delay
- 100 ns maximum propagation delay difference
- 35 kV/us minimum Common Mode Rejection (CMR) at $V_{CM} = 1500 V$
- $I_{CC} = 3.0 mA$ maximum supply current
- Wide operating range: 10 to 30 Volts (V_{CC})
- Guaranteed performance over temperature -40°C ~ +105°C.
- MSL Level 1
- Safety approval:
 - UL/ cUL Recognized 3750 $V_{RMS}/1 min$
 - IEC/EN/DIN EN 60747-5-5 $V_{IORM} = 565 V_{peak}$

1.2 Applications

- Plasma Display Panel .
- IGBT/MOSFET gate drive
- Uninterruptible power supply (UPS)
- Industrial Inverter
- Induction heating

Functional Diagram

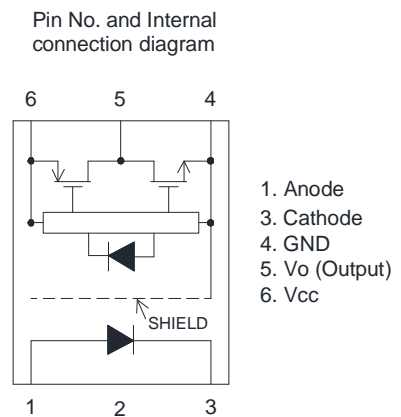

Truth Table

LED	High side	Low side	V_o
OFF	OFF	ON	Low
ON	ON	OFF	High

Note: A 0.1 μF bypass capacitor must be connected between Pin 4 and 6.

Photocoupler LTV-155E series

2. PACKAGE DIMENSIONS

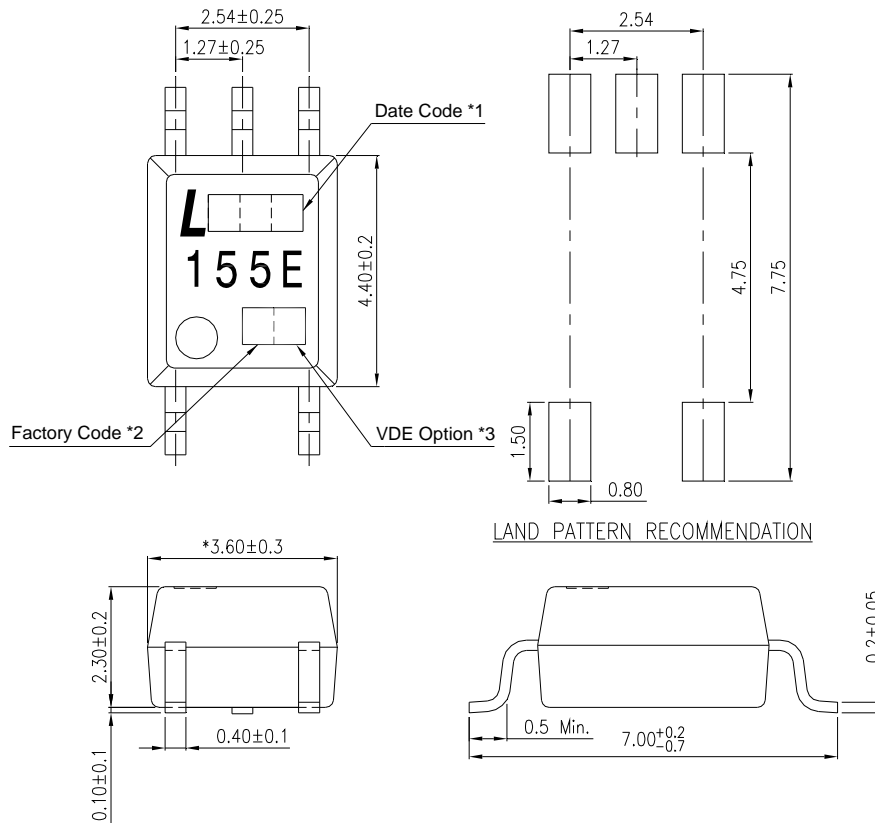

Part No : LTV-155E

Notes :

1. The first digit is year date code, second and third digit are work week
 2. Factory identification mark (W :China-CZ)
 3. "V" for VDE option
- Dimensions are all in Millimeters.

Photocoupler LTV-155E series

3. TAPING DIMENSIONS

3.1 LTV-155E

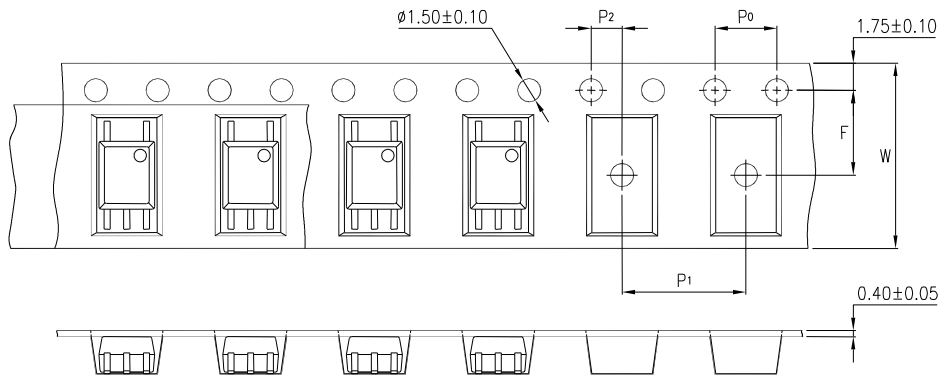

3.1 LTV-155E-TP

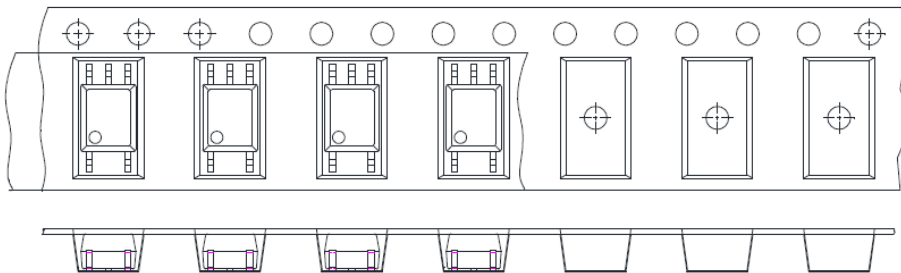

Description	Symbol	Dimension in mm (inch)
Tape wide	W	12±0.3 (0.47)
Pitch of sprocket holes	P ₀	4±0.1 (0.15)
Distance of compartment	F	5.5±0.1 (0.217)
	P ₂	2±0.1 (0.079)
Distance of compartment to compartment	P ₁	8±0.1 (0.315)

Quantities Per Reel

Package Type	LTV-155E series
Quantities (pcs)	3000

Photocoupler LTV-155E series

4. RATING AND CHARACTERISTICS

4.1 Absolute Maximum Ratings at Ta=25°C

Parameter	Symbol	Min	Max	Unit	Note
Storage Temperature	T_{stg}	-55	+125	°C	
Operating Temperature	T_{opr}	-40	+105	°C	
Output IC Junction Temperature	T_J		125	°C	
Total Output Supply Voltage	$(V_{CC} - V_{EE})$	0	35	V	
Average Forward Input Current	I_F		25	mA	
Reverse Input Voltage	V_R		5	V	
Peak Transient Input Current	$I_{F(TRAN)}$		1	A	1
“High” Peak Output Current	$I_{OH(PEAK)}$		1.0	A	2
“Low” Peak Output Current	$I_{OL(PEAK)}$		1.0	A	2
Input Current (Rise/Fall Time)	$t_{r(IN)} / t_{f(IN)}$		500	ns	3
Output Voltage	$V_{O(PEAK)}$	-0.5	V_{CC}	V	
Power Dissipation	P_I		40	mW	
Output Power Dissipation	P_O		250	mW	
Total Power Dissipation	P_T		295	mW	
Lead Solder Temperature	T_{sol}		260	°C	

Note: Ambient temperature = 25°C, unless otherwise specified. Stresses exceeding the absolute maximum ratings can cause permanent damage to the device. Exposure to absolute maximum ratings for long periods of time can adversely affect reliability.

Note: Note: A ceramic capacitor (0.1 μF) should be connected between pin 6 and pin 4 to stabilize the operation of a high gain linear amplifier. Otherwise, this Photocoupler may not switch properly. The bypass capacitor should be placed within 1 cm of each pin.

Note 1: Pulse width (PW) ≤ 1 μs, 300 pps

Note 2: Exponential waveform. Pulse width ≤ 0.3 μs, f ≤ 15 kHz

Note 3: The rise and fall times of the input on-current should be less than 500 ns

4.2 Recommended Operating Conditions

Parameter	Symbol	Min.	Max.	Unit
Operating Temperature	T_A	-30	105	°C
Supplier Voltage	V_{CC}	10	30	V
Input Current (ON)	$I_{F(ON)}$	7	16	mA
Input Voltage (OFF)	$V_{F(OFF)}$	-3.0	0.8	V

Photocoupler LTV-155E series

4.3 Electrical optical characteristics at Ta=25°C

	Parameter	Symbol	Min.	Typ.	Max.	Unit	Test Condition	Figure	Note
Input	Input Forward Voltage	V_F	1.2	1.37	1.8	V	$I_F = 10\text{mA}$	13	—
	Input Forward Voltage Temperature Coefficient	$\Delta V_F / \Delta T$	—	-1.237	—	mV/°C	$I_F = 10\text{mA}$	—	—
	Input Reverse Voltage	BV_R	5	—	—	V	$I_R = 10\mu\text{A}$	—	—
	Input Threshold Current (Low to High)	I_{FLH}	—	1.9	5	mA	$V_O > 5\text{V}, I_O = 0\text{A}$	6, 7, 18	—
	Input Threshold Voltage (High to Low)	V_{FHL}	0.8	—	—	V	$V_O < 5\text{V}, I_O = 0\text{A}$	—	—
	Input Capacitance	C_{IN}	—	33	—	pF	$f = 1\text{MHz}, V_F = 0\text{V}$	—	—
Output	High Level Supply Current	I_{CCH}	—	1.9	3.0	mA	Output Open, $I_F = 7\text{ to }16\text{mA}$	4, 5	—
	Low Level Supply Current	I_{CCL}	—	2.1	3.0	mA	Output Open, $V_F = -3\text{ to }+0.8\text{V}$		—
	High level output current	I_{OH}	—	—	-0.3	A	$V_O = (V_{CC} - 1.5\text{V})$	16	1
			—	—	-0.8		$V_O = (V_{CC} - 3\text{V})$		2
	Low level output current	I_{OL}	0.3	—	—	A	$V_O = (V_{EE} + 1.5\text{V})$	17	1
			0.8	—	—		$V_O = (V_{EE} + 3\text{V})$		2
	High level output voltage	V_{OH}	$V_{CC} - 0.6$	$V_{CC} - 0.35$	—	V	$I_F = 10\text{mA}, I_O = -100\text{mA}$	1, 2, 14	—
	Low level output voltage	V_{OL}	—	$V_{EE} + 0.25$	$V_{EE} + 0.4$	V	$I_F = 0\text{mA}, I_O = 100\text{mA}$	3, 15	—
	UVLO Threshold	V_{UVLO+}	—	7.8	—	V	$V_O > 5\text{V}, I_F = 10\text{mA}$	19	—
V_{UVLO-}		—	6.7	—	V	$V_O < 5\text{V}, I_F = 10\text{mA}$	—		
UVLO Hysteresis	$UVLO_{HYS}$	—	1.1	—	V		—	—	

All Typical values at $T_A = 25^\circ\text{C}$ and $V_{CC} - V_{EE} = 30\text{V}$, unless otherwise specified; all minimum and maximum specifications are at recommended operating condition. (Refer to 4.2)

Note 1: Maximum pulse width = 50 μs .

Note 2: Maximum pulse width = 10 μs .

Photocoupler LTV-155E series

5. SWITCHING SPECIFICATION

Parameter	Symbol	Min.	Typ.	Max.	Unit	Test Condition	Figure	Note
Propagation Delay Time to High Output Level	t_{PHL}	50	120	200	ns	$R_g = 47\Omega$, $C_g = 3nF$, $f = 10\text{ kHz}$, Duty Cycle = 50% $I_F = 7\text{ to }16\text{ mA}$, $V_{CC} = 15\text{ to }30V$ $V_{EE} = \text{ground}$	8, 9, 10, 11, 12, 20	—
Propagation Delay Time to Low Output Level	t_{PLH}	50	110	200				—
Pulse Width Distortion	PWD	—	10	70				—
Propagation delay difference between any two parts or channels	PDD	100	—	100			3	
Output Rise Time (20 to 80%)	T_r	—	35	—			20	—
Output Fall Time (80 to 20%)	T_f	—	35	—				—
Common mode transient immunity at high level output	$ CM_H $	35	50	—	kV/ μ s	$T_A = 25^\circ\text{C}$, $I_F = 10\text{ to }16\text{ mA}$, $V_{CM} = 1500\text{ V}$, $V_{CC} = 30\text{ V}$	21	1
Common mode transient immunity at low level output	$ CM_L $	35	50	—	kV/ μ s	$T_A = 25^\circ\text{C}$, $V_F = 0\text{ V}$, $V_{CM} = 1500\text{ V}$, $V_{CC} = 30\text{ V}$		2

All Typical values at $T_A = 25^\circ\text{C}$ and $V_{CC} - V_{EE} = 30\text{ V}$, unless otherwise specified; all minimum and maximum specifications are at recommended operating condition. (Refer to 4.2)

Note 1: CM_H is the maximum rate of rise of the common mode voltage that can be sustained with the output voltage in the logic high state ($V_O > 15\text{ V}$).

Note 2: CM_L is the maximum rate of fall of the common mode voltage that can be sustained with the output voltage in the logic low state ($V_O < 1\text{ V}$).

Note 3: The difference between t_{PHL} and t_{PLH} between any two parts series parts under same test conditions.

Photocoupler LTV-155E series

6. ISOLATION CHARACTERISTICS

Parameter	Test Conditions	Symbol	Min.	Typ	Max.	Unit	Note
Withstand Insulation Test Voltage	RH ≤ 40-60%, t = 1min, T _A = 25°C	V _{ISO}	3750	—	—	V	1, 2
Input-Output Resistance	V _{I-O} = 500V DC	R _{I-O}	—	10 ¹²	—	Ω	1
Input-Output Capacitance	f = 1MHz, T _A = 25°C	C _{I-O}	—	0.92	—	pF	1

All Typical values at T_A = 25°C unless otherwise specified. All minimum and maximum specifications are at recommended operating condition. (Refer to 4.2)

Note 1: Device is considered a two terminal device: pins 1 and 3 are shorted together and pins 4, 5 and 6 are shorted together.

Note 2: According to UL1577, each photocoupler is tested by applying an insulation test voltage 4500V_{RMS} for one second (leakage current less than 10uA). This test is performed before the 100% production test for partial discharge

Photocoupler LTV-155E series

7. TYPICAL PERFORMANCE CURVES & TEST CIRCUITS

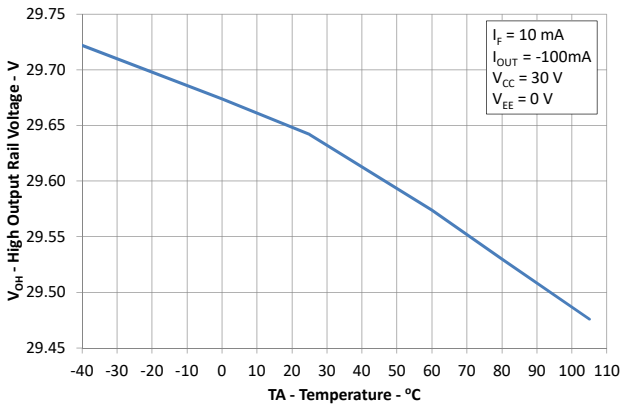

Figure 1: High output rail voltage vs. Temperature

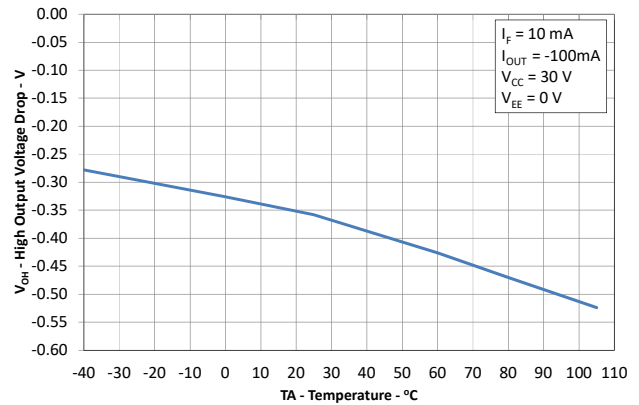

Figure 2: V_{OH} vs. Temperature

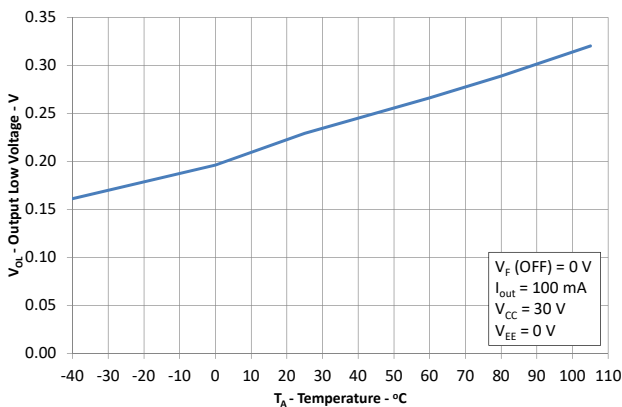

Figure 3: V_{OL} vs. Temperature

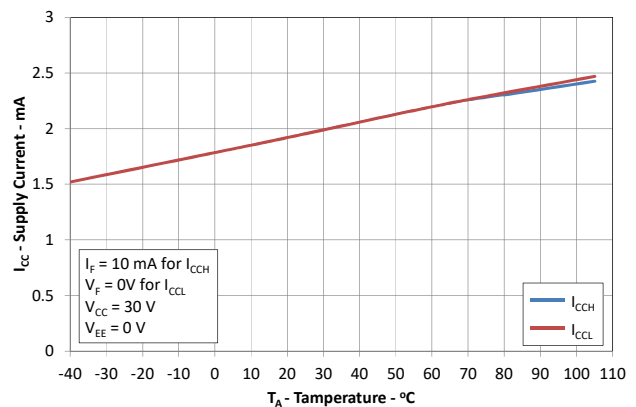

Figure 4: I_{CC} vs. Temperature

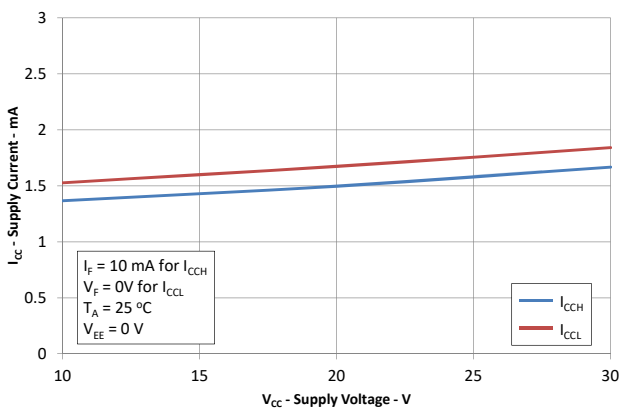

Figure 5: I_{CC} vs. V_{CC}

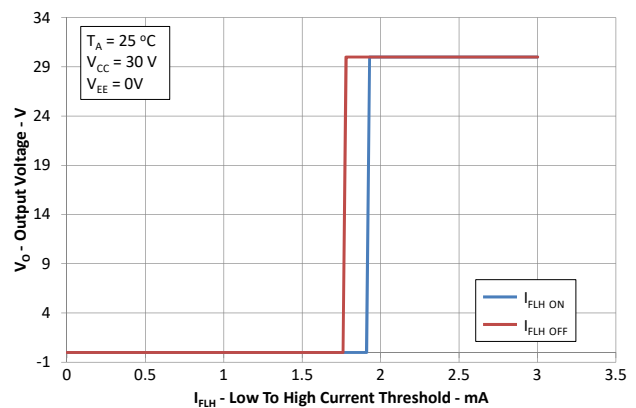

Figure 6: I_{FLH} hysteresis

Photocoupler LTV-155E series

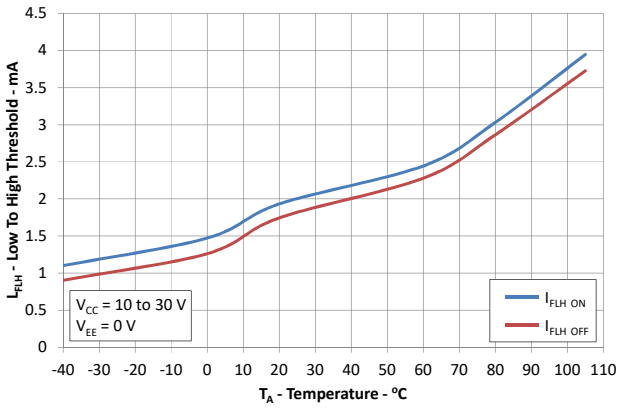

Figure 7: I_{FLH} vs. Temperature

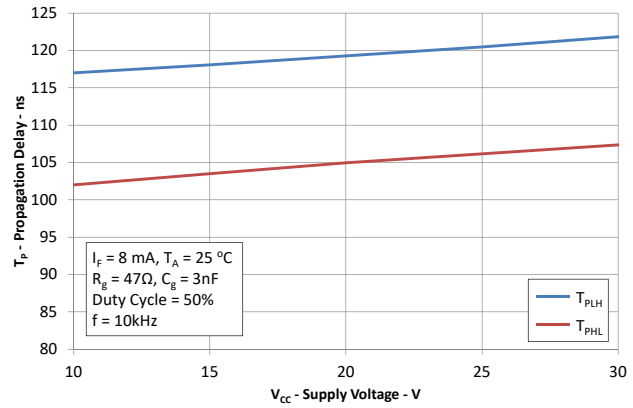

Figure 8: Propagation delays vs. V_{CC}

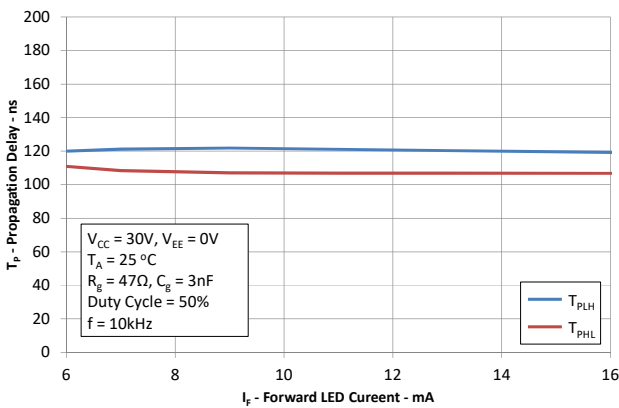

Figure 9: Propagation delays vs. I_F

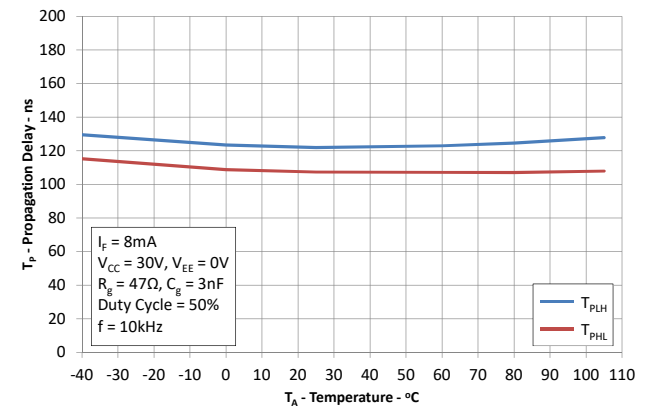

Figure 10: Propagation delays vs. Temperature

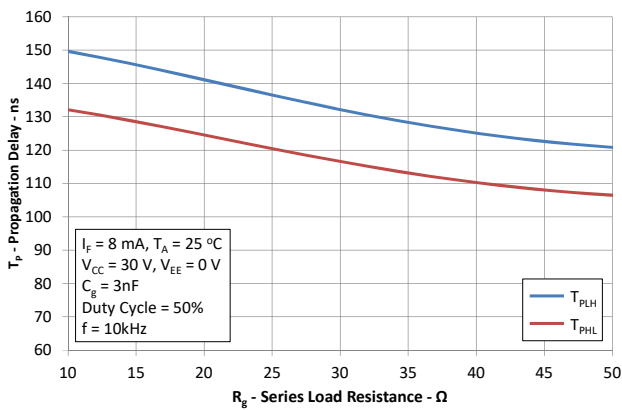

Figure 11: Propagation delays vs. R_g

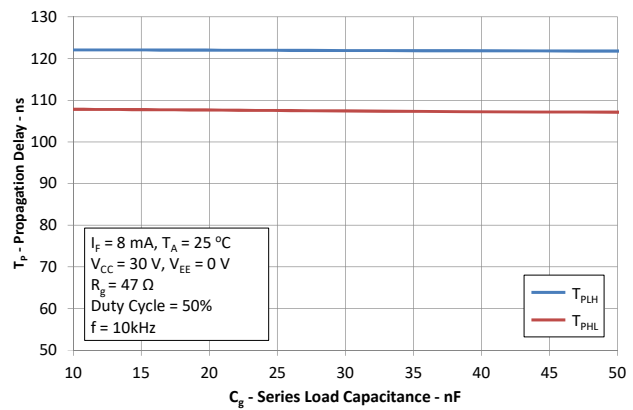

Figure 12: Propagation delays vs. C_g

Photocoupler LTV-155E series

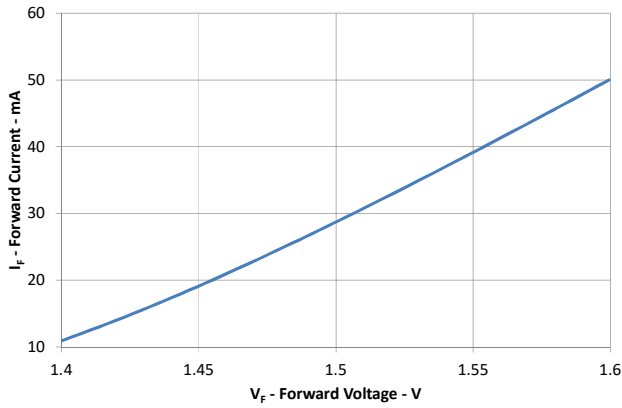

Figure 13: Input current vs. Forward voltage

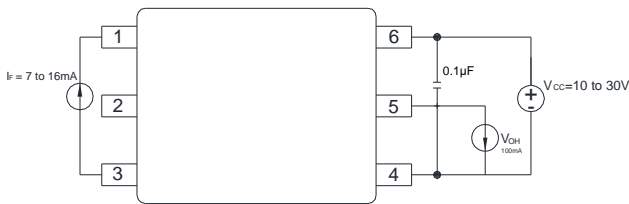

Figure 14 : V_{OH} Test Circuit

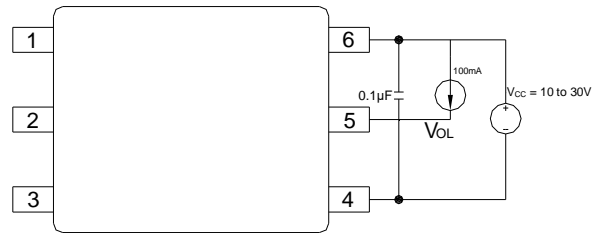

Figure 15 : V_{OL} Test Circuit

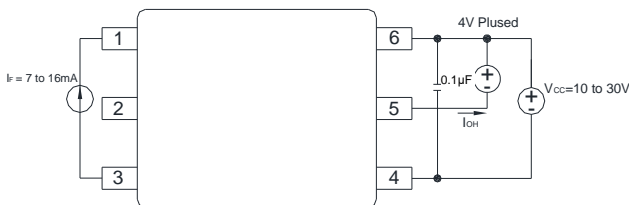

Figure 16 : I_{OH} Test Circuit

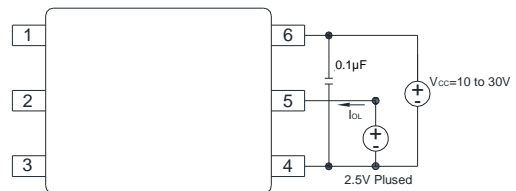

Figure 17 : I_{OL} Test Circuit

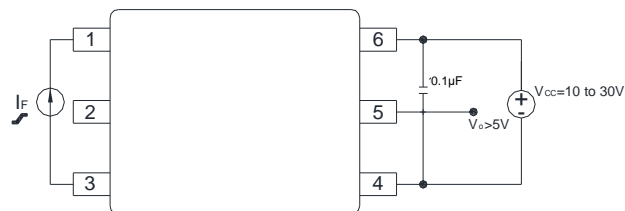

Figure 18 : I_{FLH} Test Circuit



Figure 19 : UVLO Test Circuit

Photocoupler LTV-155E series

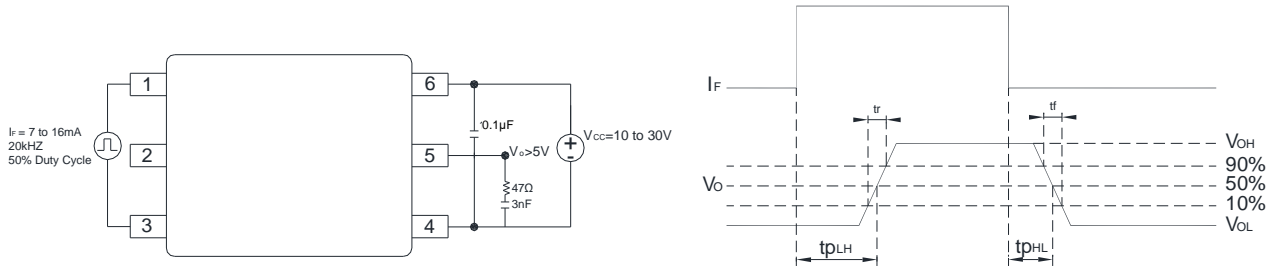

Figure 20 : t_r , t_f , t_{PLH} and t_{PHL} Test Circuit and Waveforms

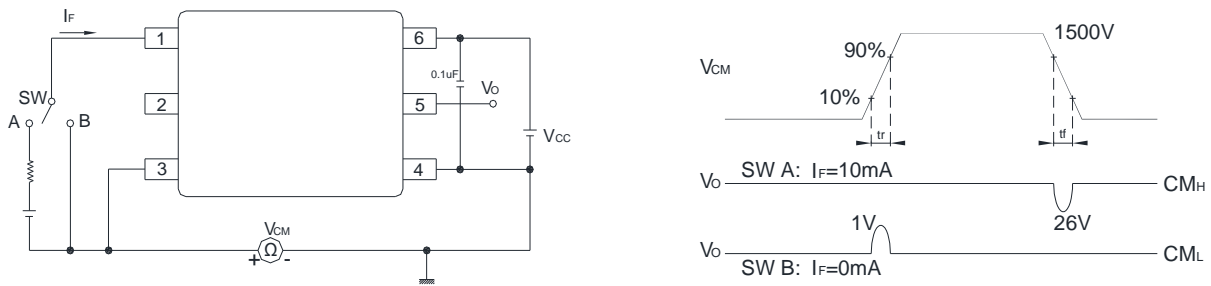

Figure 21 : CMR Test Circuit and Waveforms

Photocoupler LTV-155E series

8. TEMPERATURE PROFILE OF SOLDERING

8.1 IR Reflow soldering (JEDEC-STD-020C compliant)

One time soldering reflow is recommended within the condition of temperature and time profile shown below. Do not solder more than three times.

Profile item	Conditions
Preheat	
- Temperature Min (T_{Smin})	150°C
- Temperature Max (T_{Smax})	200°C
- Time (min to max) (ts)	90±30 sec
Soldering zone	
- Temperature (T_L)	217°C
- Time (t_L)	60 sec
Peak Temperature (T_P)	260°C
Ramp-up rate	3°C / sec max.
Ramp-down rate	3~6°C / sec

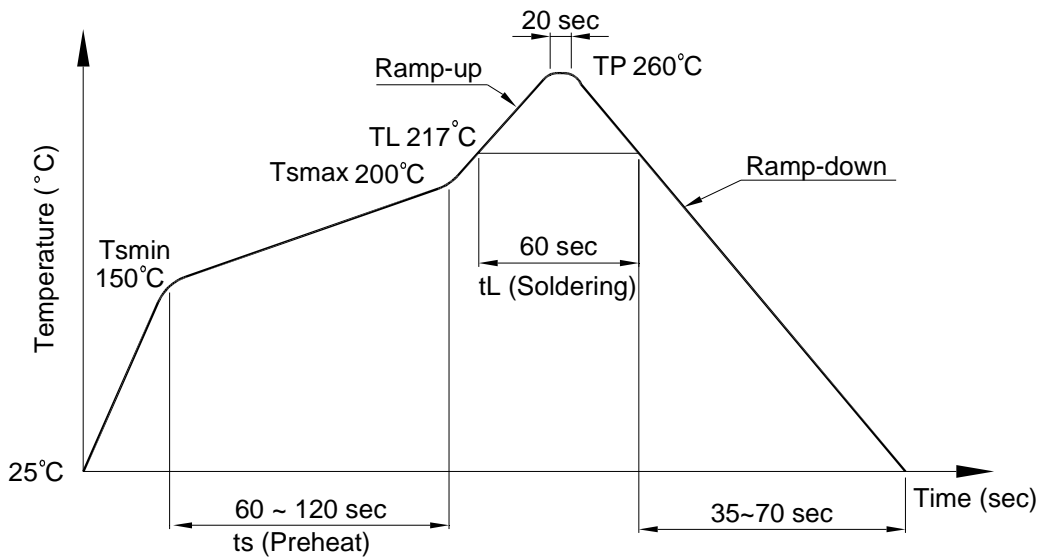

Photocoupler LTV-155E series

8.2 Wave soldering (JEDEC22A111 compliant)

One time soldering is recommended within the condition of temperature.

Temperature: $260+0/-5^{\circ}\text{C}$

Time: 10 sec.

Preheat temperature: 25 to 140°C

Preheat time: 30 to 80 sec.

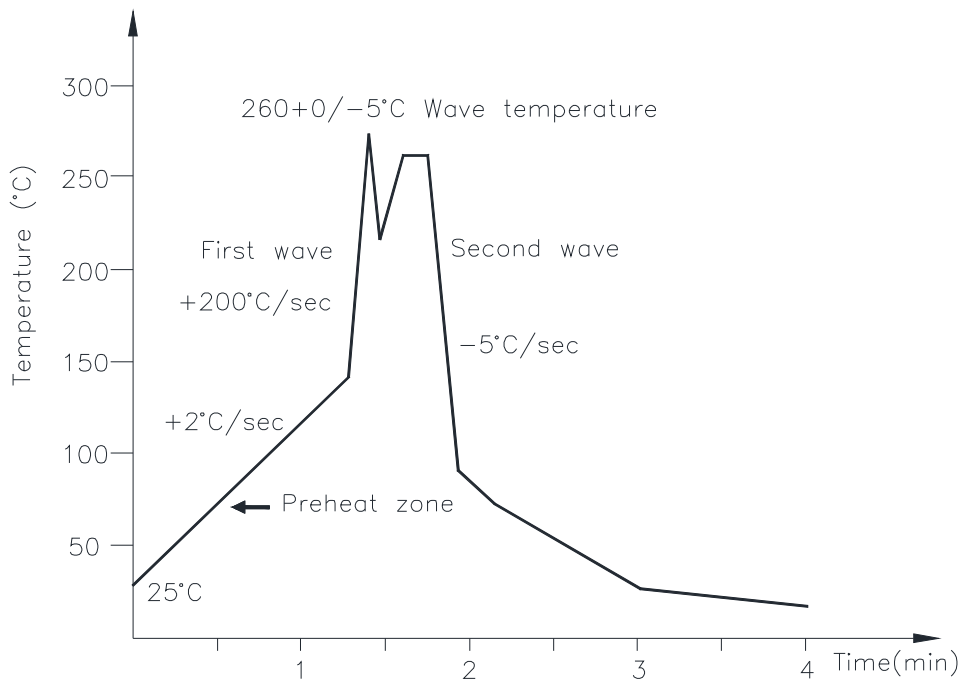

8.3 Hand soldering by soldering iron

Allow single lead soldering in every single process. One time soldering is recommended.

Temperature: $380+0/-5^{\circ}\text{C}$

Time: 3 sec max.

Photocoupler LTV-155E series

9. NAMING RULE

Part Number Options	
LTV-155E	
LTV-155E-TP	
LTV155E-V	
LTV155ETP-V	
Definition of Suffix	Remark
"155E"	LiteOn model name
"no suffix"	Pin 1 location at upper right of the tape
"TP"	Pin 1 location at lower left of the tape
"V"	VDE approved option

10. Notes:

- LiteOn is continually improving the quality, reliability, function or design and LiteOn reserves the right to make changes without further notices.
- The products shown in this publication are designed for the general use in electronic applications such as office automation equipment, communications devices, audio/visual equipment, electrical application and instrumentation.
- For equipment/devices where high reliability or safety is required, such as space applications, nuclear power control equipment, medical equipment, etc, please contact our sales representatives.
- When requiring a device for any "specific" application, please contact our sales in advice.
- If there are any questions about the contents of this publication, please contact us at your convenience.
- The contents described herein are subject to change without prior notice.
- Immerge unit's body in solder paste is not recommended.