



PART NAME

DIN RAIL BOX

PART No.

DMB-4775

REV. DATE

3-22-18

DRAWING FOR REFERENCE
 WE RESERVE THE RIGHT TO MAKE CHANGES TO OUR
 STANDARD PRODUCTS. PLEASE CONSULT WITH BUD INDUSTRIES
 PRIOR TO USING THIS DRAWING FOR DESIGN PURPOSES

MATERIAL: BODY, BASE, COVER,
 AND GUARDS - PC/ABS
 MOUNTING CLIP - NYLON66
 DIMENSIONS ARE MM[INCH]

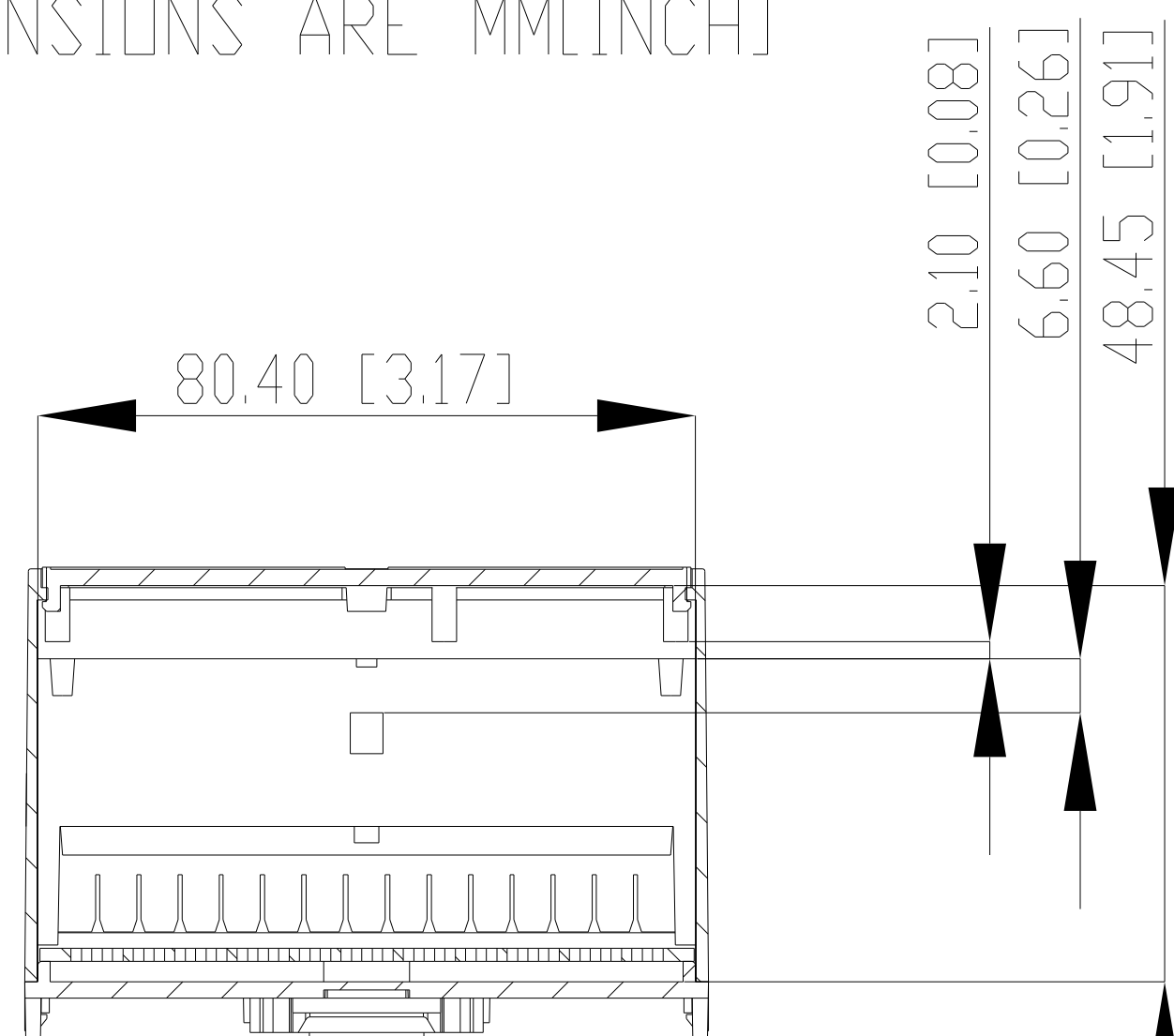
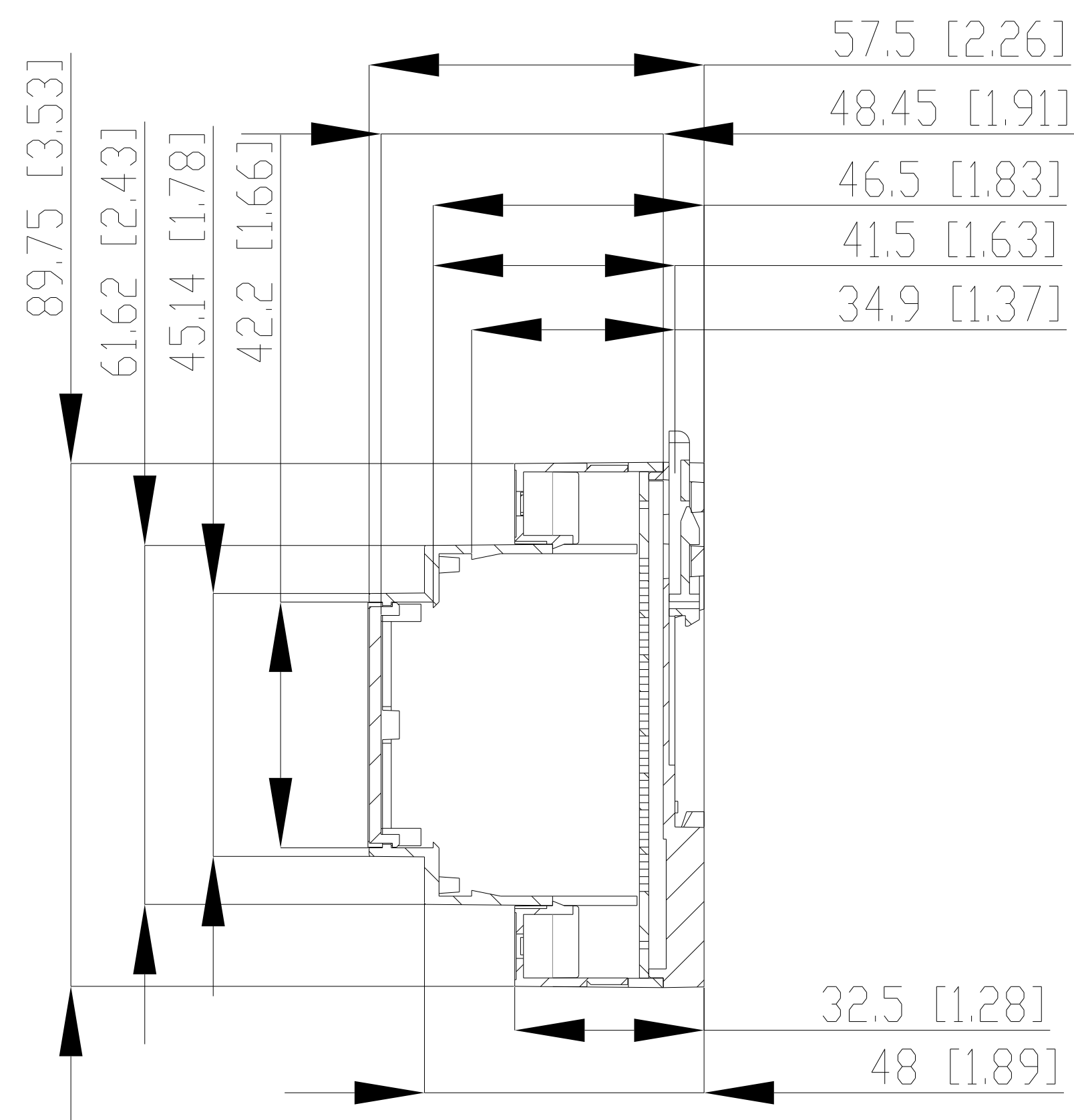
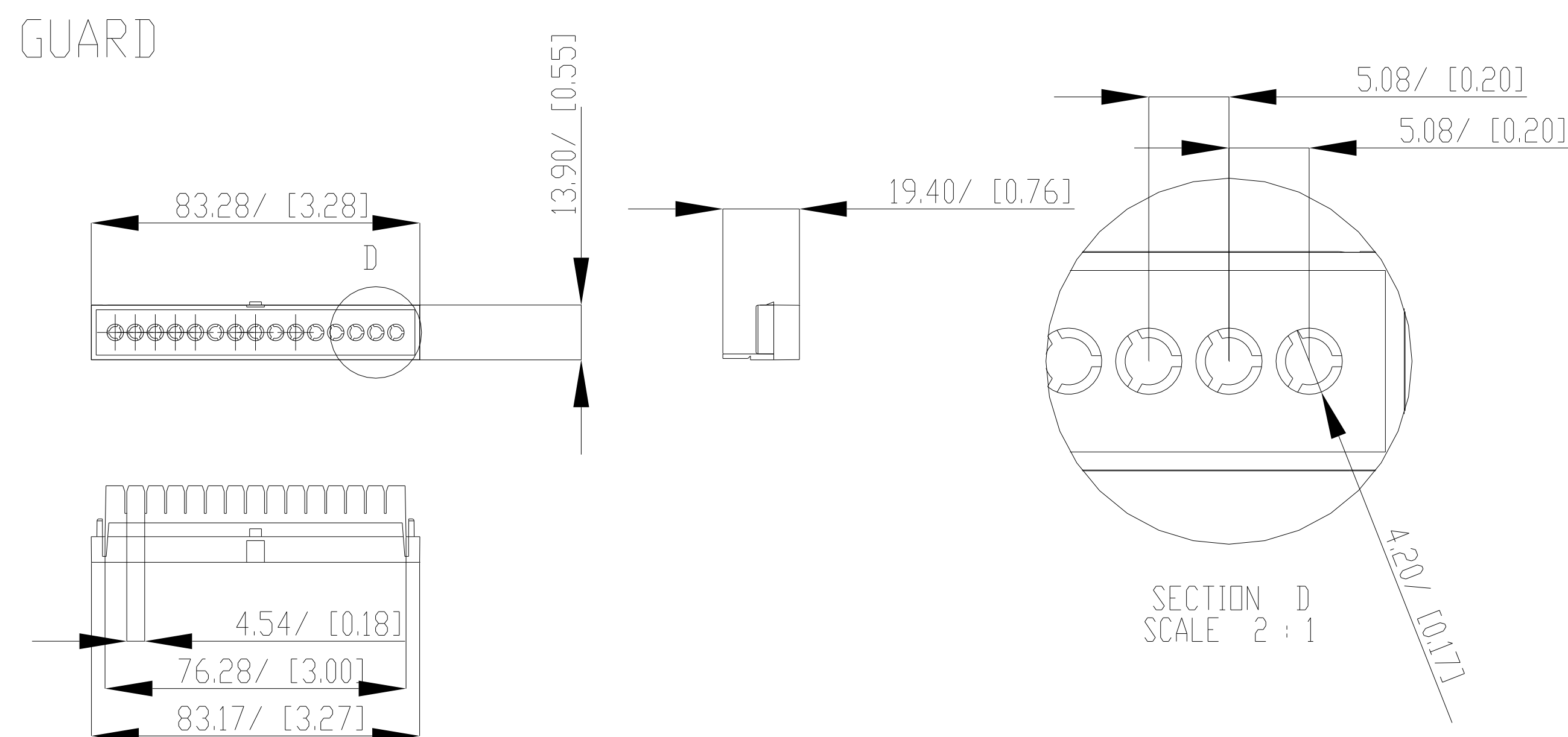
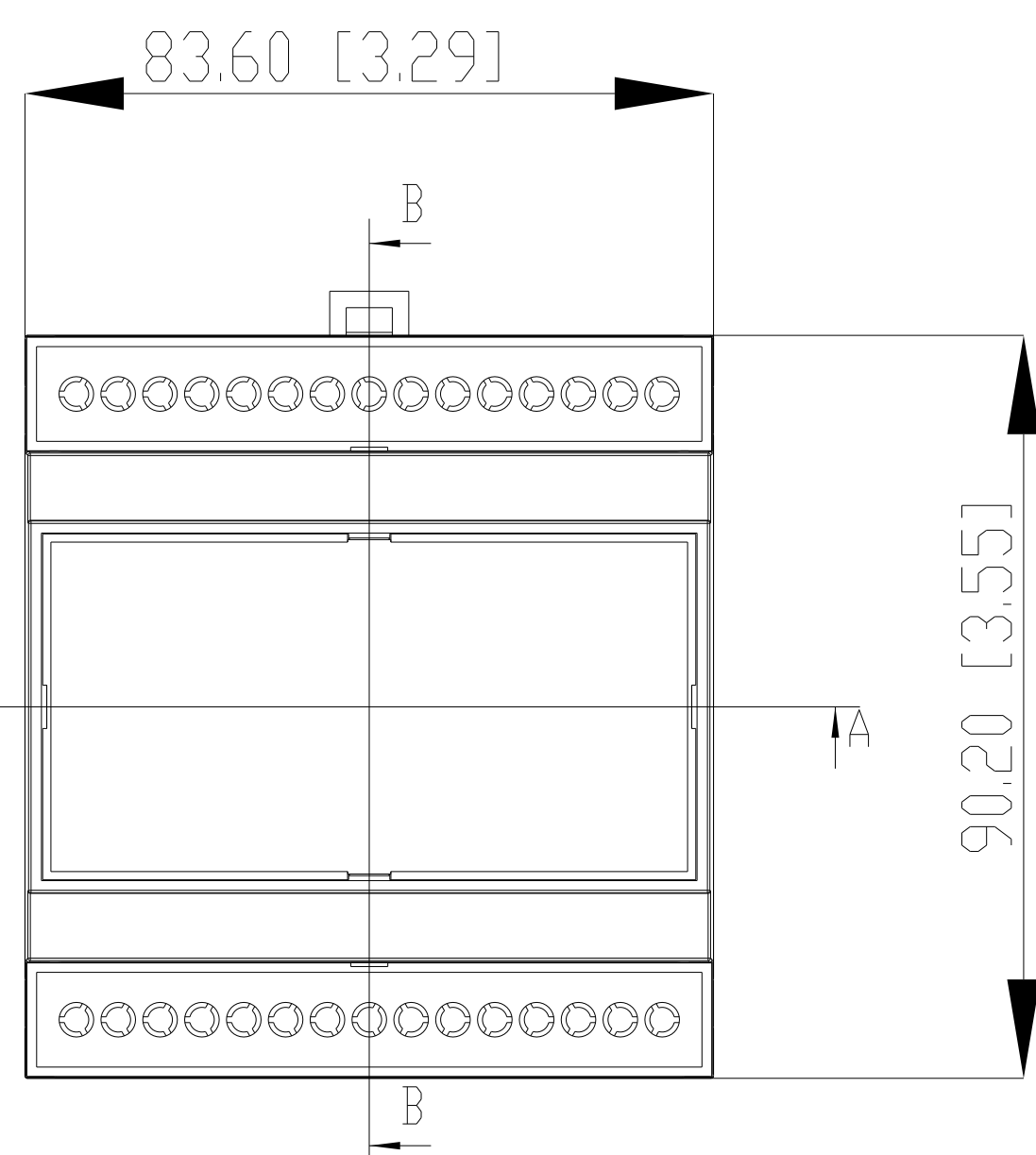
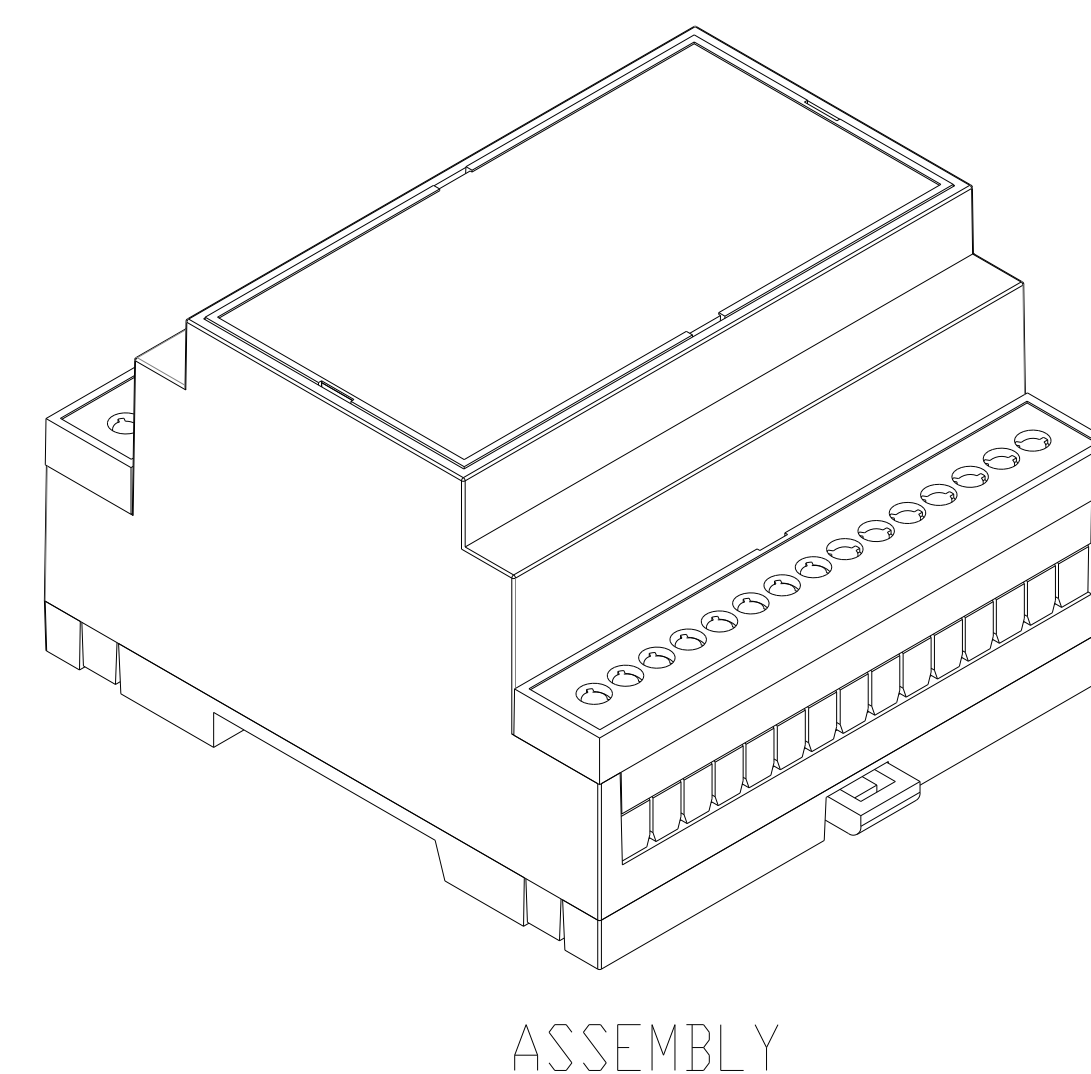
SECTION D
SCALE 2 : 1SECTION B-B
SCALE 2 : 3

ASSEMBLY

BODY

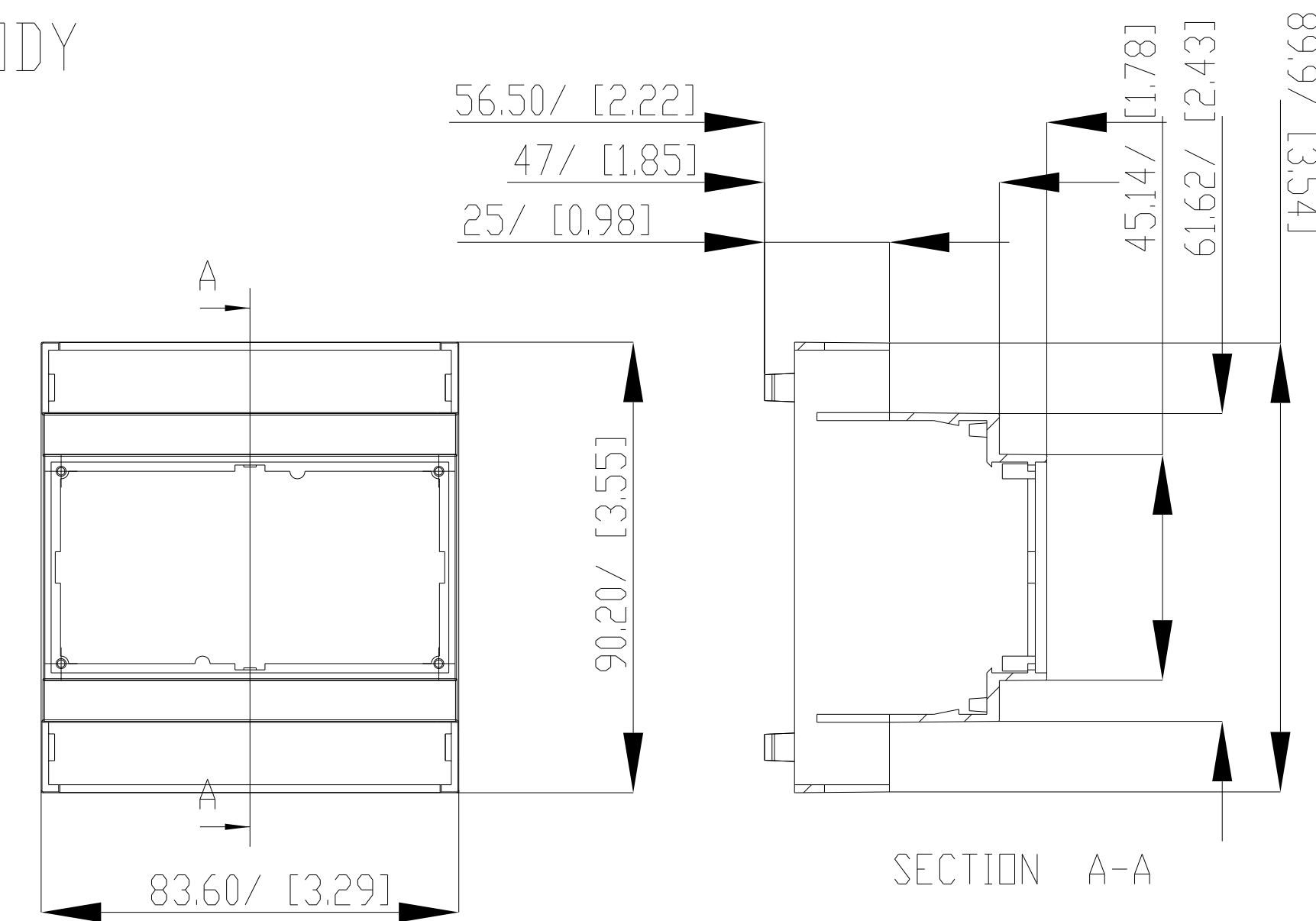

BASE

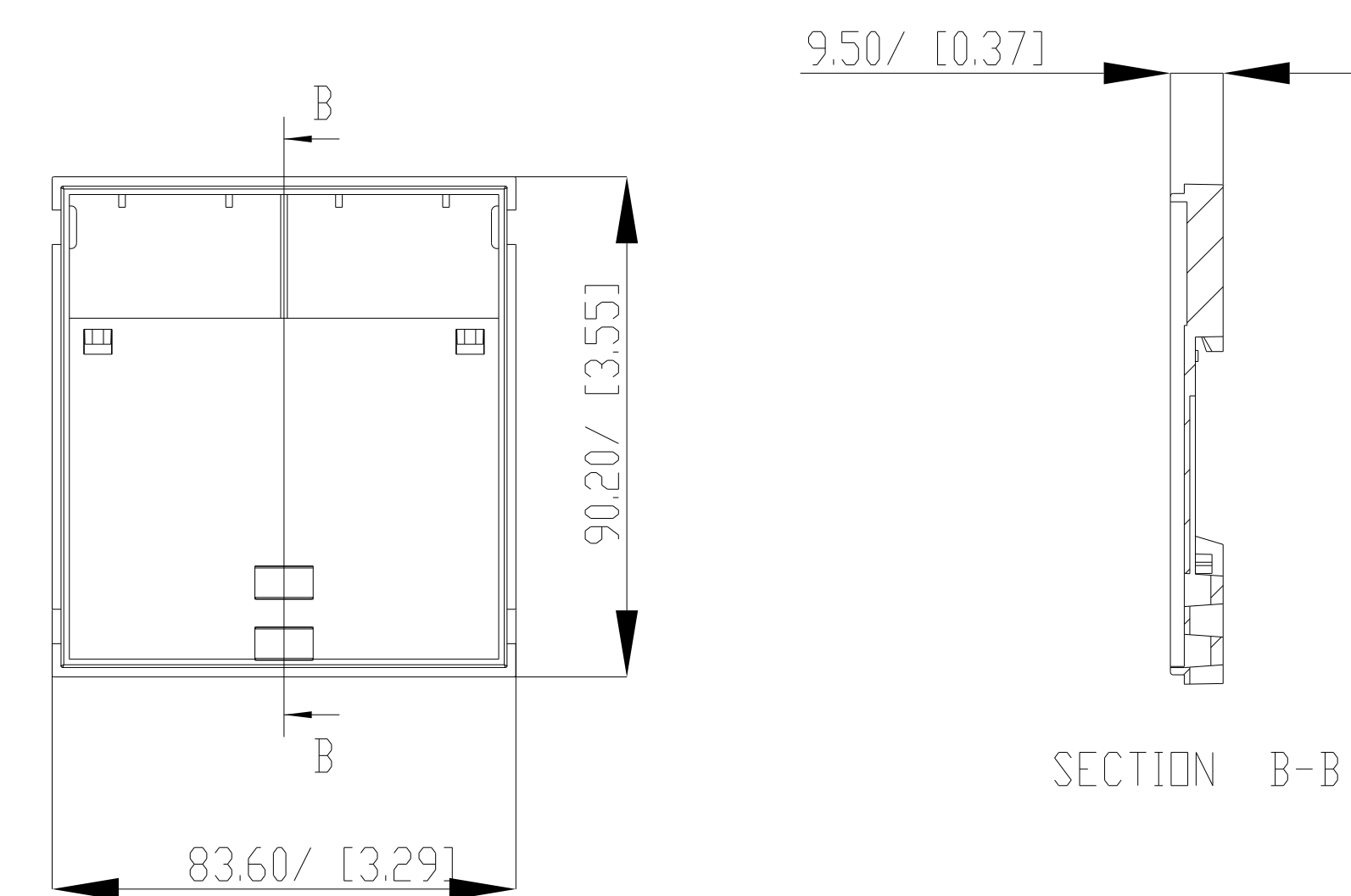

COVER

