

# FTDI Chip

## VM810C Datasheet

### Embedded Video Engine Credit Card Board



*General Purpose Multi Media Controller*

## 1 Introduction

The VM810C is a development module for FTDI's FT810, which is used to develop and demonstrate the functionality of the FT810 Embedded Video Engine, EVE. This module behaves as an SPI slave, and requires a SPI Master for proper micro-controller interfacing and system integration.

VM810C modules support 5.0" LCD panel size options. Users can also connect to different LCD screens as long as they meet the FT810 technical specification and fit the VM810C LCD connector.

- VM810C50A-D, 3.3/5V micro-controller adaptor card with 5.0" LCD
- VM810C50A-N, 3.3/5V micro-controller adaptor card, with 4.3/5.0" LCD connector but no display

### 1.1 Features

The VM810C utilises the FTDI FT810 Embedded Video Engine. Graphic, audio and touch features of the FT810 can be accessed with the VM810C. For a full list of the FT810's features please see the FT810 datasheet. The VM810C has the following features:

- Ready to use LCD module
- Options with or without 5" LCDs supporting resistive touch with pressure sensing
- On board LCD backlight LED Driver
- Supports mono audio output
- On board audio power amplifier and micro speaker
- Flexible power supply. Powering the VM810C using SPI host connector, or via USB Micro-B port, or via a 2.0mm JST connector
- 5 V tolerant buffers when used with a 5V SPI Master.

## 2 Ordering Information

Note that the kits below require a 5V/1A power supply. It is NOT provided in the development kit, but is offered as an optional accessory, as is the USB to SPI cable, with the following part types:

Part No.	Description
<b>VM810C50A-N</b>	<b>Credit Card Size VM810C module, supports 3.3/5v MCU Adapter Board, with FPC/FFC 40 LCD connector. No display is provided.</b>
<b>VM810C50A-D</b>	<b>Credit Card Size VM810C module, supports 3.3/5v MCU Adapter Board, with FPC/FFC 40 LCD connector. Includes 5 inch 800x480 TFT LCD display with resistive touch panel.</b>
<b>VA-PSU-UK1</b>	<b>Accessory - UK Model 5V/1A USB Power Supply (Mfr # JX-B0520C-1-B)</b>
<b>VA-PSU-US1</b>	<b>Accessory - US Model 5V/1A USB Power Supply (Mfr # JX-B0520B-1-B)</b>
<b>VA-PSU-EU1</b>	<b>Accessory - EU Model 5V/1A USB Power Supply (Mfr # JX-B0520A-1-B)</b>
<b>VA800A-SPI</b>	<b>Accessory - High Speed Micro USB to SPI adapter for BASIC boards based on FT232H MPSSE design</b>
<b>VA-FC-1M-BKW</b>	<b>Accessory - Flat USB A to Micro B Cable 1M- Black and White</b>
<b>VA-FC-1M-BLW</b>	<b>Accessory - Flat USB A to Micro B Cable 1M- Blue and White</b>
<b>VA-FC-STYLUS1</b>	<b>Accessory - Resistive Touch Screen Pen Stylus</b>

Table 2-1 – Ordering information

---

## Table of Contents

<b>1</b>	<b>Introduction .....</b>	<b>1</b>
1.1	<b>Features.....</b>	<b>1</b>
<b>2</b>	<b>Ordering Information .....</b>	<b>2</b>
<b>3</b>	<b>Hardware Description.....</b>	<b>4</b>
3.1	<b>VM810C board.....</b>	<b>4</b>
3.2	<b>Physical Descriptions .....</b>	<b>5</b>
3.2.1	PCB layout.....	5
3.2.2	VM810C Connectors.....	6
<b>4</b>	<b>Board Schematics .....</b>	<b>9</b>
<b>5</b>	<b>Hardware Setup Guide.....</b>	<b>11</b>
5.1	<b>Power Configuration .....</b>	<b>11</b>
5.2	<b>MPSSE Setup.....</b>	<b>11</b>
<b>6</b>	<b>Mechanical Dimensions .....</b>	<b>14</b>
<b>7</b>	<b>Specifications .....</b>	<b>15</b>
7.1	<b>Optical Specification .....</b>	<b>15</b>
<b>8</b>	<b>Contact Information .....</b>	<b>16</b>
	<b>Appendix A - References .....</b>	<b>17</b>
	<b>Appendix C – Revision History.....</b>	<b>19</b>

### 3 Hardware Description

Please refer to section 3.2.2 for connector settings. Some VM810C jumpers must be set to work properly with your system.

#### 3.1 VM810C board

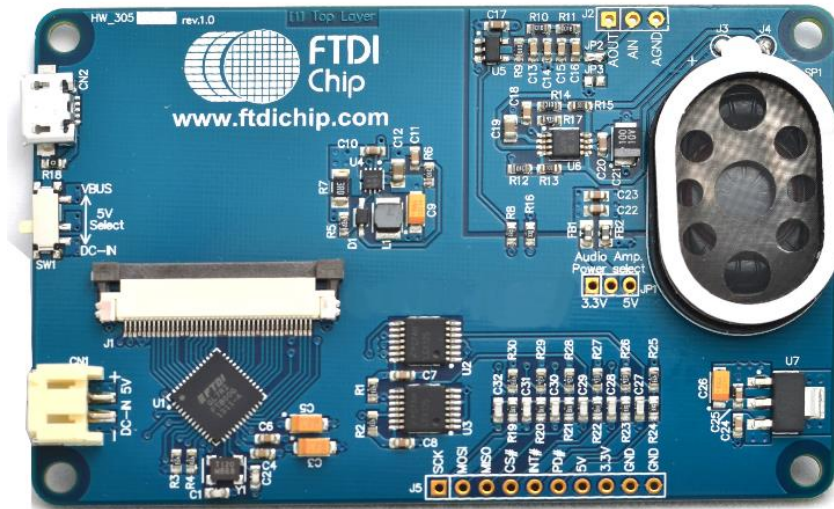

**Figure 3-1 – VM810C board top view**

The VM810C module is intended for direct use into existing applications that require a display. This module is suitable for interfacing with an external microcontroller that has a SPI Master channel.

The main functions of the VM810C are as follows:

- Micro USB, SPI connector or 2-pin connector for power supply
- 3.3V regulator : Takes 5V input and outputs 3.3V for on-board circuits
- WVGA(800x480) TFT LCD touch screen panel (for the VM810C50A-D module)
- LCD backlight driver. On board back light driver has over voltage protection (OVP) of 34V, and drive current 32mA.
- 5V tolerant buffers between the SPI master interface and the Slave interface of the FT810
  - SPI timing requirements can be referenced in the FT810 datasheet. The on board level converter buffers introduce additional delay. The actual maximum SPI clock frequency depends on the host system timing and connection cable length to the VM810C.
- 3 stage audio filter and power amplifier
- 8Ω speaker
- Audio line out option

## 3.2 Physical Descriptions

### 3.2.1 PCB layout

The VM810C is an 85.6mm x 54.1mm, four-layer printed circuit board. Board thickness is approximately 1.6mm.

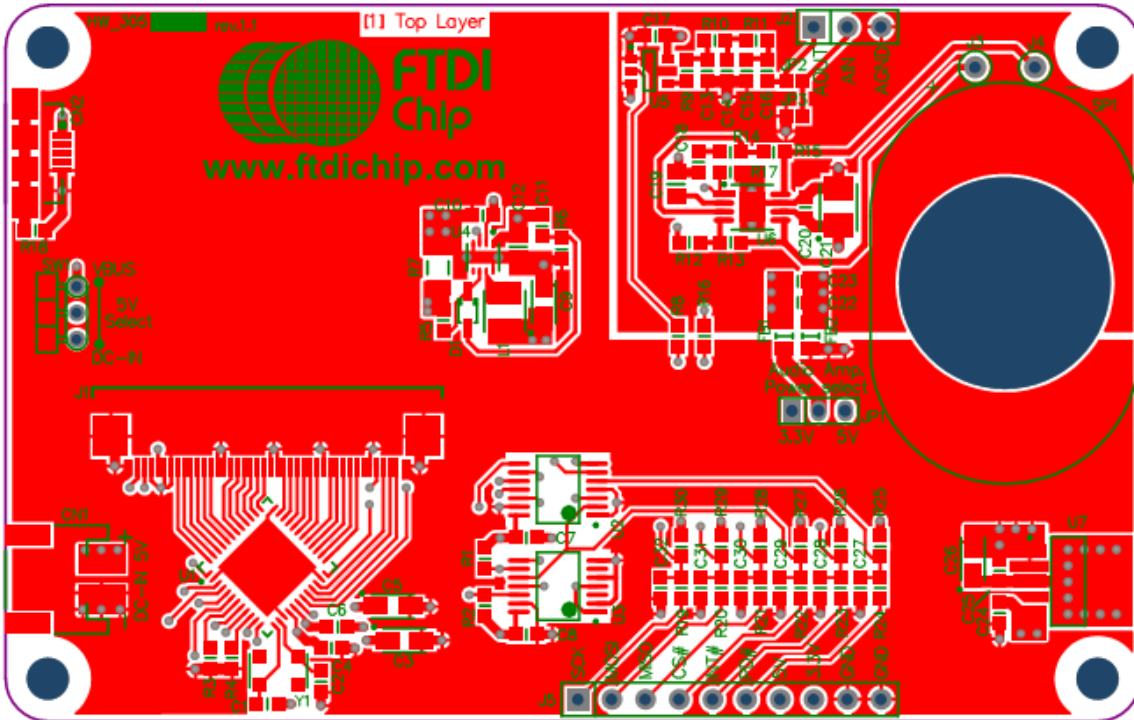

Figure 3-2 – VM810C board top layer

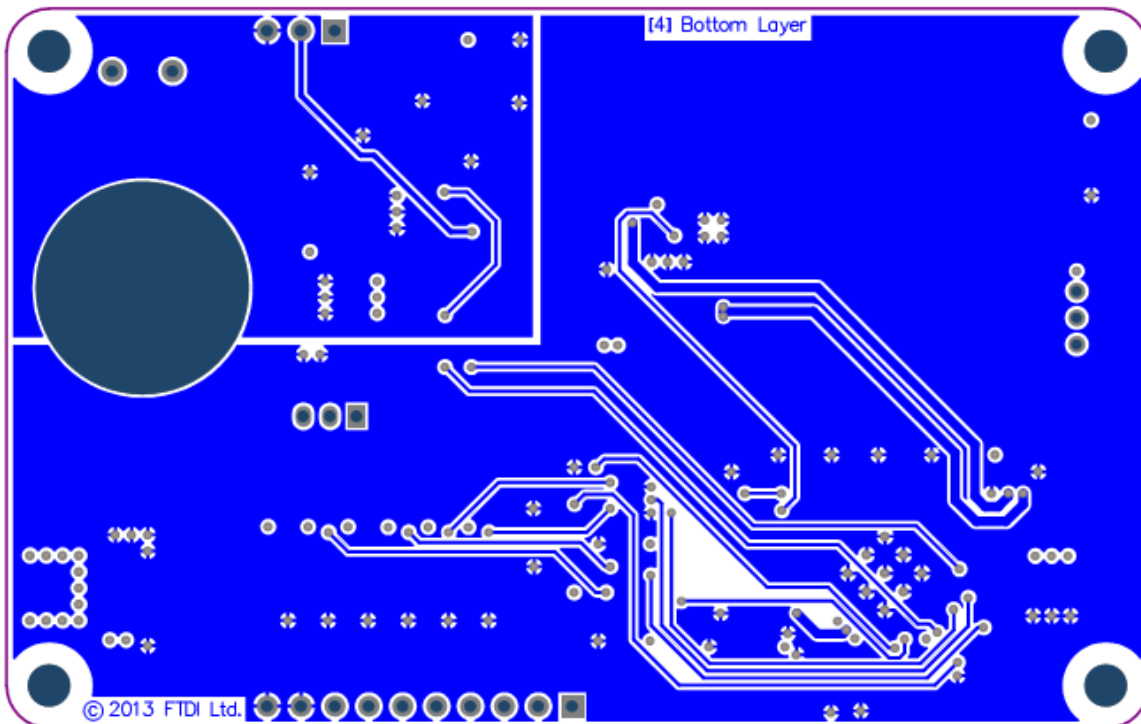

Figure 3-3 – VM810C board bottom layer

### 3.2.2 VM810C Connectors

Connectors and jumpers are described in the following sections.

- **CN1- 2-pin power connector**

2 pin JST connector for 5V/3.3V power input to the board. Alternative to Micro USB connector.

Pin No.	Name	Type	Description
1	VCC	P	5V power supply
2	GND	P	Ground

**Table 3-1 – CN1 Pinout**

- **CN2- Micro USB Receptical**

This receptical is strictly for 5V input to power the board. There is no USB Functionality

Pin No.	Name	Type	Description
1	VBUS	P	5V power supply
2	NC	NA	No connection
3	NC	NA	No connection
4	NC	NA	No connection
5	GND	P	Ground

**Table 3-2 – CN2 Pinout**

- **J1- LCD Flex Cable connector**

This connector is the interface between the FT810 IC and the LCD Module.

Signal	Pin No	Description
LED K	1	LED-
LED A	2	LED+
DISP	31	LCD Display Enable
HSYNC	32	LCD Horizontal Sync
VSYNC	33	LCD Vertical Sync
DCLK	30	LCD Pixel Clock
DE	34	LCD Data Enable
R2	7	Bit 2 of Red RGB signals
R3	8	Bit 3 of Red RGB signals
R4	9	Bit 4 of Red RGB signals
R5	10	Bit 5 of Red RGB signals
R6	11	Bit 6 of Red RGB signals
R7	12	Bit 7 of Red RGB signals

Signal	Pin No	Description
G2	15	Bit 2 of Green RGB signals
G3	16	Bit 3 of Green RGB signals
G4	17	Bit 4 of Green RGB signals
G5	18	Bit 5 of Green RGB signals
G6	19	Bit 6 of Green RGB signals
G7	20	Bit 7 of Green RGB signals
B2	23	Bit 2 of Blue RGB signals
B3	24	Bit 3 of Blue RGB signals
B4	25	Bit 4 of Blue RGB signals
B5	26	Bit 5 of Blue RGB signals
B6	27	Bit 6 of Blue RGB signals
B7	28	Bit 7 of Blue RGB signals
XP	37	touch panel X right
YM	38	touch panel Y down
XM	39	touch panel X left
YP	40	touch panel Y up
3V3	4	3V3 Power
GND	3,5,6,13,14,21,22,29,36	Ground
NC	35	No connect

**Table 3-3 – J1 Pinout**

- **J2 - Selection between lineout or loop back into the power amplifier.**

Selection between audio lineout or loop back into the power amplifier. (Footprint only, JP2 next to J2 is connected by default for on board amplifier and on board mini speaker). If J2 is soldered and used for audio output selection, JP2 needs to be removed.

Pin	Name	Description
1	Audio line out	Use pin 1 and 3 for FT810 audio line out to external speaker
2	Audio line in	Short pin1 and 2 to loopback FT810 audio into the on-board power amplifier
3	Audio GND	Audio GND

**Table 3-4 – J2 Pin Options**

- **J3 – SP+**

Audio speaker +ve from the onboard amplifier.

- **J4 – SP-**

Audio speaker -ve from the onboard amplifier.

- **J5- SPI Interface**

This is the interface where the SPI control and data signals are routed. There are also power and ground pins on this interface. Note J5 is not soldered on the VM810C board by default.

Pin No.	Name	Type	Description
1	SCLK	I	SPI Clock input
2	MOSI	I	Master Out Slave in
3	MISO	O	Master In Slave out
4	CS#	I	Chip select , active low
5	INT#	OD	Host interrupt open drain output, active low. On board 47kΩ pull-up to 3.3V.
6	PD#	I	Active low power down input.
7	5V	P	5V power supply
8	3.3V	P	3.3V power supply
9	GND	P	Ground
10	GND	P	Ground

**Table 3-5 – J5 Pinout**

- **JP1- Audio Amplifier Power Select**

This jumper provides the option to select the power supply voltage for the onboard power amplifier.

Pin No.	Name
1-2	3V3 selected (default, recommended)
2-3	5V selected

**Table 3-6 – JP1 Pin options**

\*This needs to be configured before audio can be heard.

- **JP2 – On board amplifier enable**

Solder connection fitted by default.

- **JP3 - On board amplifier mute**

Solder connection not fitted by default. Do not fit this solder connection.

- **SW1 – Power source select**

Pin No.	Name
1-2	Power from CN1
2-3	Power from CN2

**Table 3-7 – JP1 Pin options**



## 4 Board Schematics

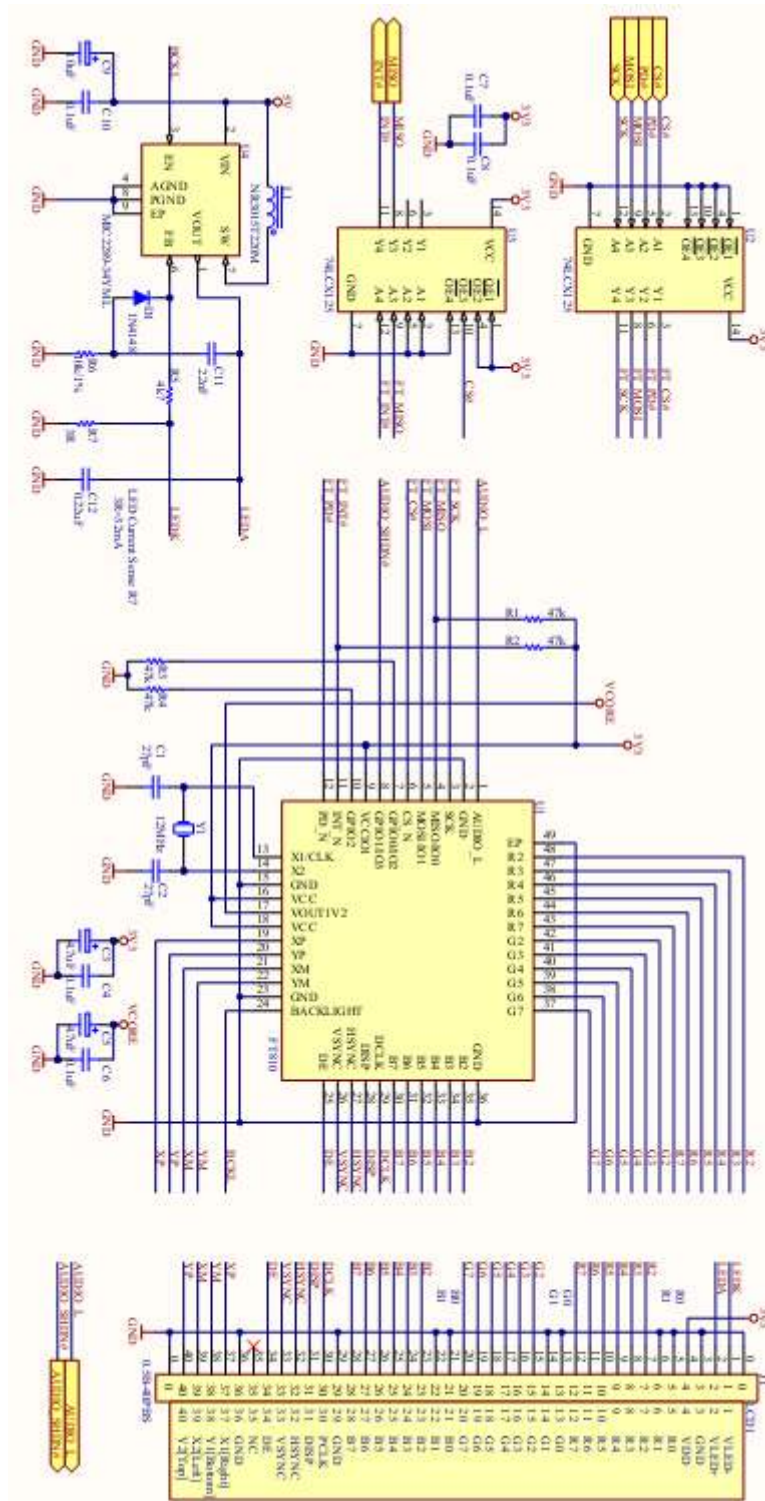

Figure 4-1 - FT810 and LCD circuit



## 5 Hardware Setup Guide

### 5.1 Power Configuration

There are 3 methods of powering the VM810C board.

- 1) USB Power(5V) - Connect USB power through micro-USB cable to CN2
- 2) DC IN(5V) - Connect 5V to CN1
- 3) J5 Power(5V) - Connect 5V to J5 pin 7

The following table summarise how to power the VM810C board using the various methods.

Power Method	CN2	CN1	J5 Pin 7	SW1
USB Power	5V	N/C	N/C	Short pin 2-3
DC IN(5V)	N/C	5V	N/C	Short pin 1-2
J5 Power(5V)	N/C	N/C	5V	Any Position

**Table 5-1 – Board power configuration**

### 5.2 MPSSE Setup

To give a quick start with the VM810C development board, a Windows based Sample Application and demo applications are provided for users to experiment and experience the FT810 in the VM810C system. The following paragraphs provide a short description for development procedures.

MPSSE is a “multi purpose synchronous serial engine” interface available in some FTDI device (e.g. FT2232D, FT232H, FT2232H and FT4232H). This engine allows users to bridge from a USB port on a PC to an SPI interface. Sample code is available for driving the FT810 over this interface with a FT232H device that has been integrated into a cable. This device is available in the VA800A-SPI board, or C232HM-EDHSL-0(5V) cable or C232HM-DDHSL-0(3.3V) cable.

VA800A-SPI is a MPSSE module accessory which can connect to the VM810C modules directly. Detailed information of VA800A-SPI can be found at:

[http://www.ftdichip.com/Support/Documents/DataSheets/Modules/DS\\_VA800A-SPI\\_MPSSE\\_Module.pdf](http://www.ftdichip.com/Support/Documents/DataSheets/Modules/DS_VA800A-SPI_MPSSE_Module.pdf).

More information about MPSSE cables may be found at:

[http://www.ftdichip.com/Support/Documents/DataSheets/Cables/DS\\_C232HM\\_MPSSE\\_CABLE.pdf](http://www.ftdichip.com/Support/Documents/DataSheets/Cables/DS_C232HM_MPSSE_CABLE.pdf).

In this section it is assumed the 5V version of the MPSSE cable (FTDI part no C232HM-EDHSL-0) is used. If the 3.3V version of the MPSSE cable (FTDI part no C232HM-DDHSL-0) is available, the setup is similar except for the power pin connection which requires an additional 5V power source to connect to CN2 or CN1. Refer to table 5-1 for board power configuration.

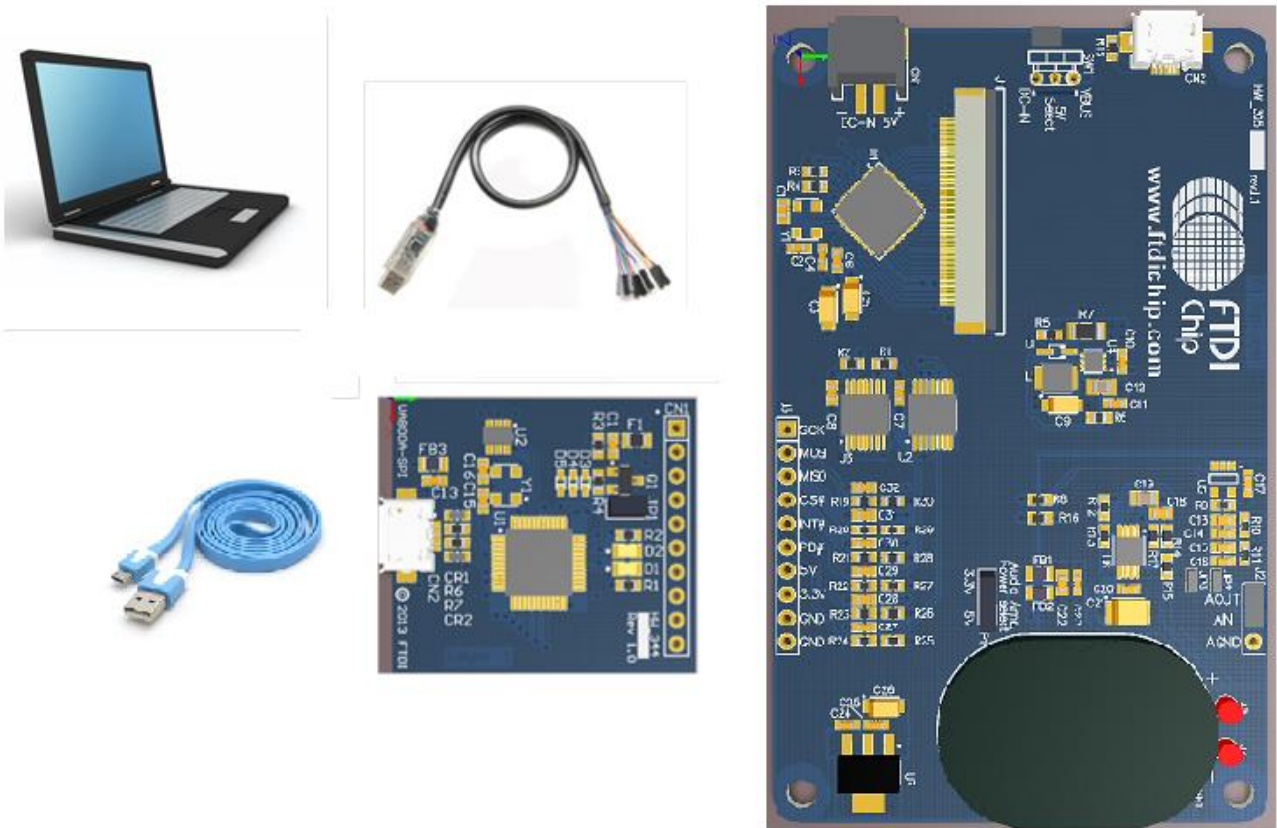

**Figure 5-1 – VM810C connects to PC via VA800A-SPI or MPSSE cable.**

**Hardware Setup VA800A-SPI**

- Solder a 10 position single row pin header to J5 footprint of the VM810C board
- Connect VA800A-SPI to the VM810C module in the correct orientation(pin1 to pin1 aligned).
- Connect USB cable (e.g. FTDI accessory **VA-FC-1M-BKW** or **VA-FC-1M-BLW**) from the VA800A-SPI to the PC USB host port.
- VA800A-SPI will supply power to VM810C after MPSSE driver is properly loaded and the USB host completed USB device configuration.

**Hardware Setup MPSSE Cable**

- Solder a 10 position single row pin header to J5 footprint of the VM810C board
- Connect MPSSE leads to VM810C board’s J5( SPI interface) in accordance with Table 5-2
- Plug MPSSE cable to PC USB host port

**Software Setup**

- Download PC based MPSSE software libraries. MPSSE cable and driver information can be found at <http://www.ftdichip.com/Products/Cables/USBMPSSE.htm>.
- Launch the Sample Application based on MPSSE from the PC
- For more information on utilizing the VM810C development system with the MPSSE cable and Sample Application, refer to AN\_245. Note the procedure is the same as for previous generation VM800C modules.

Further documentation associated with the VM810C development system and design flow can be found at following link: <http://www.ftdichip.com/Products/Modules/VM810C.html>

The [FT81x Programming Guide](#) describes the programming code and formats used by the FT810. The Sample Application is a well-formatted, and documented program that illustrates the Programming Guide, and provides numerous design examples and reference code demonstrations.

J5 Pin number	J5 Signal	MPSSE pin number	MPSSE Signal	MPSSE Lead Color
1	SCK	2	SK	ORANGE
2	MOSI	3	DO	YELLOW
3	MISO	4	DI	GREEN
4	CS#	5	CS	BROWN
5	INT#	7	GPIOL1	PURPLE
6	PD#	9	GPIOL3	BLUE
7	5V	1	VCC	RED
8	3.3V	-	-	-
9	GND	10	GND	Black
10	GND	-	-	-

**Table 5-2 – MPSSE cable (C232HM-EDHSL-0) connection**



## 6 Mechanical Dimensions

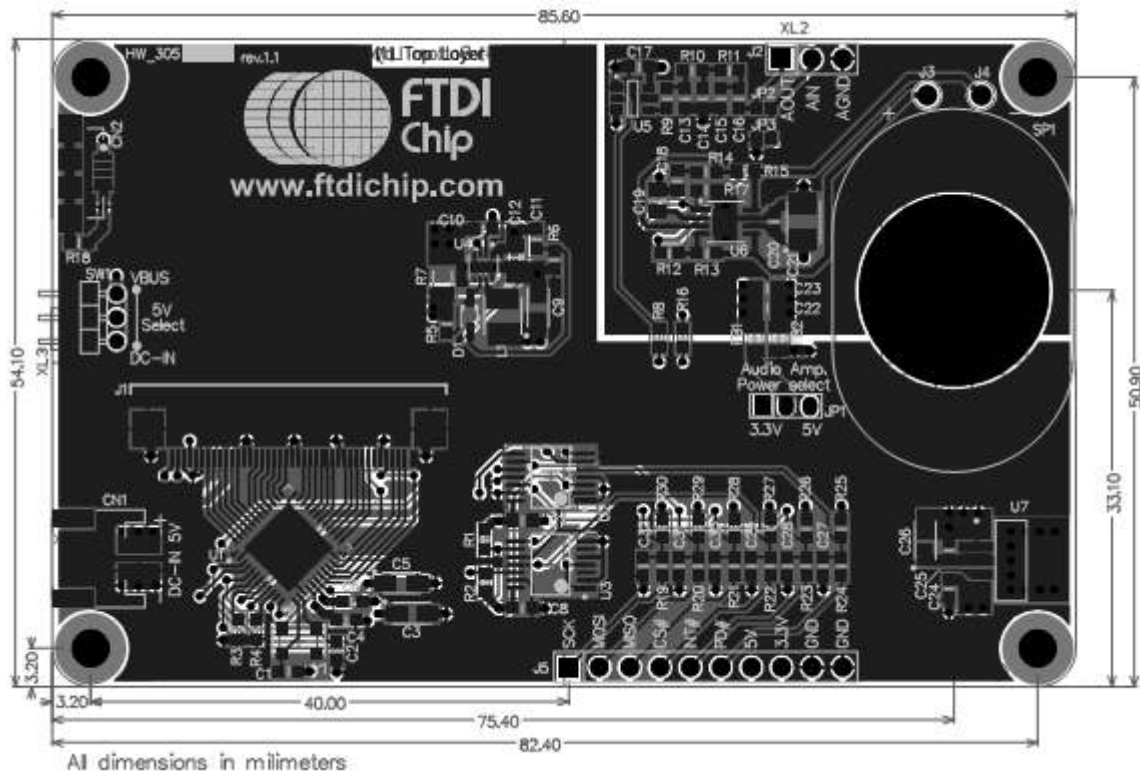

Figure 6-1 – PCB mechanical dimensions

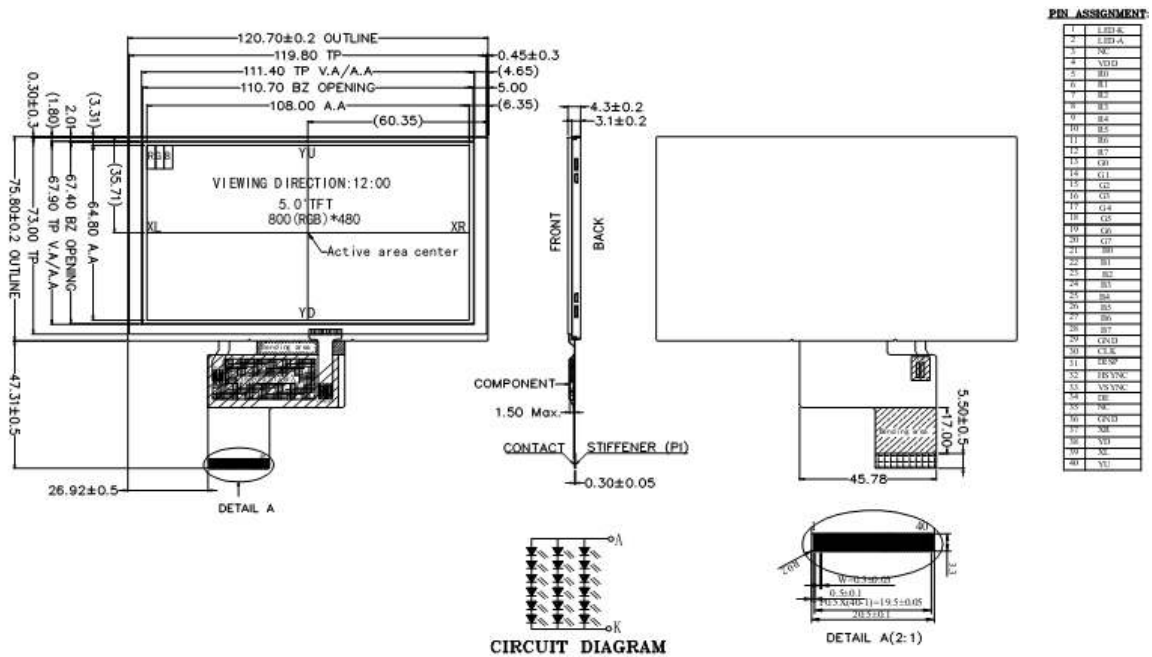

Figure 6-2 – 5" WVGA LCD dimensions

## 7 Specifications

### 7.1 Optical Specification

Item	Symbol	Condition	Min.	Typ.	Max.	Unit	Note	
Brightness (With TP)	Bp	$\theta=0^\circ$ $\Phi=0^\circ$		400	-	Cd/m <sup>2</sup>	1	
Uniformity	$\Delta$ Bp		75	-	-	%	1,2	
Viewing Angle	3:00	Cr $\geq$ 10	-	60	-	Deg	3	
	6:00		-	45	-			
	9:00		-	60	-			
	12:00		-	60	-			
Contrast Ratio	Cr	$\theta=0^\circ$ $\Phi=0^\circ$	300	500		-	4	
Response Time	T <sub>r</sub>		-	10	-	ms	5	
	T <sub>f</sub>		-	10	-	ms		
Color of CIE Coordinate	W	x		0.28		-	1,6	
		y		0.33		-		
	R	x		0.51		-		
		y		0.34		-		
	G	x	$\theta=0^\circ$ $\Phi=0^\circ$		0.31			-
		y			0.56			-
	B	x			0.15			-
		y			0.14			-
NTSC Ratio	S		50	60	-	%		

Note: The parameter is slightly changed by temperature, driving voltage and material

Note 1: The data are measured after LEDs are turned on for 5 minutes. LCM displays full white.  
 The brightness is the average value of 9 measured spots. Measurement equipment PR-705 ( $\Phi$ 8mm)

Measuring condition:

- Measuring surroundings: Dark room.
- Measuring temperature: Ta=25°C.
- Adjust operating voltage to get optimum contrast at the center of the display.

Measured value at the center point of LCD panel after more than 5 minutes while backlight turning on.

**Table 7-1 – 5" TFT Optiocal Specification**

## 8 Contact Information

### Head Office – Glasgow, UK

Unit 1, 2 Seaward Place, Centurion Business Park  
Glasgow G41 1HH  
United Kingdom  
Tel: +44 (0) 141 429 2777  
Fax: +44 (0) 141 429 2758

E-mail (Sales) [sales1@ftdichip.com](mailto:sales1@ftdichip.com)  
E-mail (Support) [support1@ftdichip.com](mailto:support1@ftdichip.com)  
E-mail (General Enquiries) [admin1@ftdichip.com](mailto:admin1@ftdichip.com)

### Branch Office – Tigard, Oregon, USA

7130 SW Fir Loop  
Tigard, OR 97223  
USA  
Tel: +1 (503) 547 0988  
Fax: +1 (503) 547 0987

E-Mail (Sales) [us.sales@ftdichip.com](mailto:us.sales@ftdichip.com)  
E-Mail (Support) [us.support@ftdichip.com](mailto:us.support@ftdichip.com)  
E-Mail (General Enquiries) [us.admin@ftdichip.com](mailto:us.admin@ftdichip.com)

### Branch Office – Taipei, Taiwan

2F, No. 516, Sec. 1, NeiHu Road  
Taipei 114  
Taiwan, R.O.C.  
Tel: +886 (0) 2 8797 1330  
Fax: +886 (0) 2 8751 9737

E-mail (Sales) [tw.sales1@ftdichip.com](mailto:tw.sales1@ftdichip.com)  
E-mail (Support) [tw.support1@ftdichip.com](mailto:tw.support1@ftdichip.com)  
E-mail (General Enquiries) [tw.admin1@ftdichip.com](mailto:tw.admin1@ftdichip.com)

### Branch Office – Shanghai, China

Room 1103, No. 666 West Huaihai Road,  
Changning District, Shanghai, 200052  
China  
Tel: +86 (0)21 6235 1596  
Fax: +86 (0)21 6235 1595

E-mail (Sales) [cn.sales@ftdichip.com](mailto:cn.sales@ftdichip.com)  
E-mail (Support) [cn.support@ftdichip.com](mailto:cn.support@ftdichip.com)  
E-mail (General Enquiries) [cn.admin@ftdichip.com](mailto:cn.admin@ftdichip.com)

### Web Site

<http://ftdichip.com>

### Distributor and Sales Representatives

Please visit the Sales Network page of the [FTDI Web site](#) for the contact details of our distributor(s) and sales representative(s) in your country.

System and equipment manufacturers and designers are responsible to ensure that their systems, and any Future Technology Devices International Ltd (FTDI) devices incorporated in their systems, meet all applicable safety, regulatory and system-level performance requirements. All application-related information in this document (including application descriptions, suggested FTDI devices and other materials) is provided for reference only. While FTDI has taken care to assure it is accurate, this information is subject to customer confirmation, and FTDI disclaims all liability for system designs and for any applications assistance provided by FTDI. Use of FTDI devices in life support and/or safety applications is entirely at the user's risk, and the user agrees to defend, indemnify and hold harmless FTDI from any and all damages, claims, suits or expense resulting from such use. This document is subject to change without notice. No freedom to use patents or other intellectual property rights is implied by the publication of this document. Neither the whole nor any part of the information contained in, or the product described in this document, may be adapted or reproduced in any material or electronic form without the prior written consent of the copyright holder. Future Technology Devices International Ltd, Unit 1, 2 Seaward Place, Centurion Business Park, Glasgow G41 1HH, United Kingdom. Scotland Registered Company Number: SC136640



## Appendix A - References

For module documentations, please refer to URL below:

<http://www.ftdichip.com/Products/Modules/VM810C.html>

FT810 datasheet: [DS\\_FT81x](#)

FT810 software programming guide: [FT81x Programmer Guide](#)

C232HM-DDHSL-0 datasheet:

[http://www.ftdichip.com/Support/Documents/DataSheets/Cables/DS\\_C232HM\\_MPSSE\\_CABLE.pdf](http://www.ftdichip.com/Support/Documents/DataSheets/Cables/DS_C232HM_MPSSE_CABLE.pdf)

D2xx Programmers Guide:

[http://www.ftdichip.com/Support/Documents/ProgramGuides/D2XX\\_Programmer's\\_Guide\(FT\\_000071\).pdf](http://www.ftdichip.com/Support/Documents/ProgramGuides/D2XX_Programmer's_Guide(FT_000071).pdf)

AN\_108: Command Processor for MPSSE and MCU Host Bus Emulation Modes

**8.1.1.1.1.1.1.1.1** [http://www.ftdichip.com/Support/Documents/AppNotes/AN\\_108\\_Command\\_Processor\\_for\\_MPSSE\\_and\\_MCU\\_Host\\_Bus\\_Emulation\\_Modes.pdf](http://www.ftdichip.com/Support/Documents/AppNotes/AN_108_Command_Processor_for_MPSSE_and_MCU_Host_Bus_Emulation_Modes.pdf)

## Appendix B - List of Figures and Tables

### List of Figures

Figure 3-1 – VM810C board top view .....	4
Figure 3-2 – VM810C board top layer .....	5
Figure 3-3 – VM810C board bottom layer .....	5
Figure 4-1 - FT810 and LCD circuit .....	9
Figure 4-2 – SPI Interface Circuit .....	10
Figure 4-3 – Audio Circuit .....	10
Figure 5-1 – VM810C connects to PC via VA800A-SPI or MPSSE cable.....	12
Figure 6-1 – PCB mechanical dimensions .....	14
Figure 6-2 – 5” WVGA LCD dimensions .....	14

### List of Tables

Table 2-1 – Ordering information .....	2
Table 3-2 – CN1 Pinout.....	6
Table 3-3 – CN2 Pinout.....	6
Table 3-4 – J1 Pinout .....	7
Table 3-5 – J2 Pin Options .....	7
Table 3-6 – J5 Pinout .....	8
Table 3-7 – JP1 Pin options .....	8
Table 3-8 – JP1 Pin options .....	8
Table 5-1 – Board power configuration .....	11
Table 5-2 – MPSSE cable (C232HM-EDHSL-0) connection.....	13
Table 7-3 – 5” TFT Opticall Specification.....	15

## **Appendix C – Revision History**

Document Title: DS\_VM810C  
Document Reference No.: FT\_001225  
Clearance No.: FTDI# 464  
Product Page: <http://www.ftdichip.com/eve.htm>  
Document Feedback: [Send Feedback](#)

**Version 1.0** Initial Datasheet released

14 Sept 2015