

25 A - 800 V - T-series Triac in D²PAK

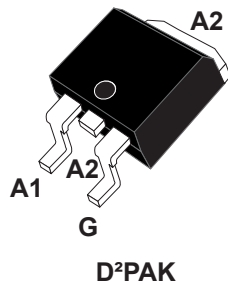

A2: Anode2
A1: Anode1
G: Gate

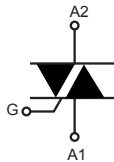

Product status link

[T2535T-8G](#)

Product summary

$I_{T(RMS)}$	25 A
V_{DRM}, V_{RRM}	800 V
V_{DSM}, V_{RSM}	900 V
I_{GT}	35 mA

Features

- 25 A medium current Triac
- 150 °C maximum junction temperature T_J
- Surge capability $V_{DSM}, V_{RSM} = 900 V$
- Three triggering quadrants
- High noise immunity - static dV/dt
- Robust dynamic turn-off commutation - $(di/dt)_c$
- **ECOPACK2** compliant component

Applications

- General purpose AC line load control
- AC induction and universal motor control
- Heating: water heater, e-bidet
- Power tools
- Cooker, oven
- Lighting and automation I/O control
- Inrush current limiting circuits
- Overvoltage crowbar protection

Description

The **T2535T-8G** Triac in SMD D²PAK package can be used for the on/off or phase angle control function in general purpose AC switching.

Based on the ST Snubberless technology, it offers higher specified turn-off commutation and noise immunity levels up to 150 °C.

SMD D²PAK package is suitable for automatic assembly line.

The **T2535T-8G** safely optimizes the control of the motors and heaters loads for the most constraining environments of home appliances.

1 Characteristics

Table 1. Absolute maximum ratings (limiting values)

Symbol	Parameter		Value	Unit
$I_{T(RMS)}$	RMS on-state current (full sine wave)		$T_c = 121\text{ °C}$ 25	A
I_{TSM}	Non repetitive surge peak on-state current (full cycle, T_j initial = 25 °C)		$t = 16.7\text{ ms}$ 210	A
			$t = 20\text{ ms}$ 200	
I^2t	I^2t value for fusing		$t_p = 10\text{ ms}$ 264	A^2s
di/dt	Critical rate of rise of on-state current, $I_G = 2 \times I_{GT}$, $t_r \leq 100\text{ ns}$, $f = 100\text{ Hz}$		$f = 120\text{ Hz}$ 100	$A/\mu s$
V_{DRM}/V_{RRM}	Repetitive peak off-state voltage		$T_j = 125\text{ °C}$ 800	V
			$T_j = 150\text{ °C}$ 600	
V_{DSM}/V_{RSM}	Non Repetitive peak off-state voltage	$t_p = 10\text{ ms}$ $T_j = 25\text{ °C}$	900	V
I_{GM}	Peak gate current	$t_p = 20\text{ }\mu s$ $T_j = 150\text{ °C}$	4	A
P_{GM}	Maximum gate power dissipation	$t_p = 20\text{ }\mu s$ $T_j = 150\text{ °C}$	5	W
$P_{G(AV)}$	Average gate power dissipation	$T_j = 150\text{ °C}$	1	W
T_{stg}	Storage temperature range		-40 to +150	°C
T_j	Operating junction temperature range		-40 to +150	°C
T_L	Maximum lead temperature for soldering during 10 s		260	°C

Table 2. Electrical characteristics ($T_j = 25\text{ °C}$, unless otherwise specified)

Symbol	Test conditions	Quadrants		Value	Unit
I_{GT}	$V_D = 12\text{ V}$, $R_L = 30\text{ }\Omega$	I - II - III	Min.	5	mA
			Max.	35	
V_{GT}			Max.	1	V
V_{GD}	$V_D = V_{DRM}$, $R_L = 3.3\text{ k}\Omega$, $T_j = 150\text{ °C}$	I - II - III	Min.	0.15	V
I_L	$I_G = 1.2 \times I_{GT}$	I - III	Max.	50	mA
		II	Max.	80	
$I_H^{(1)}$	$I_T = 500\text{ mA}$, gate open		Max.	35	mA
$dV/dt^{(1)}$	$V_D = 536\text{ V}$, gate open	$T_j = 125\text{ °C}$	Min.	1500	$V/\mu s$
	$V_D = 402\text{ V}$, gate open	$T_j = 150\text{ °C}$	Min.	1000	$V/\mu s$
$(di/dt)_c^{(1)}$	Without snubber network	$T_j = 125\text{ °C}$	Min.	28	A/ms
		$T_j = 150\text{ °C}$	Min.	18	A/ms

1. For both polarities of A2 referenced to A1.

Table 3. Static characteristics

Symbol	Test conditions			Value	Unit
$V_{TM}^{(1)}$	$I_{TM} = 35 \text{ A}$, $t_p = 380 \text{ } \mu\text{s}$	$T_j = 25 \text{ }^\circ\text{C}$	Max.	1.5	V
$V_{TO}^{(1)}$	Threshold voltage	$T_j = 150 \text{ }^\circ\text{C}$	Max.	0.80	V
$R_D^{(1)}$	Dynamic resistance	$T_j = 150 \text{ }^\circ\text{C}$	Max.	17	m Ω
I_{DRM}/I_{RRM}	$V_D = V_R = 800 \text{ V}$, peak voltage	$T_j = 25 \text{ }^\circ\text{C}$	Max.	5	μA
		$T_j = 125 \text{ }^\circ\text{C}$		5	mA
	$V_D = V_R = 600 \text{ V}$, peak voltage	$T_j = 150 \text{ }^\circ\text{C}$	Max.	6	mA
		$T_j = 150 \text{ }^\circ\text{C}$	Max.	5	

1. For both polarities of A2 referenced to A1.

Table 4. Thermal resistance

Symbol	Parameter		Value	Unit
$R_{th(j-c)}$	Junction to case (AC)	Max.	1	$^\circ\text{C/W}$
$R_{th(j-a)}$	Junction to ambient ($S_{CU} = 2 \text{ cm}^2$)	Typ.	45	

1. S_{cu} : copper pad surface under tab, 35 μm copper thickness on FR4 PCB.

1.1 Characteristics (curves)

Figure 1. Maximum power dissipation versus on-state RMS current (full cycle)

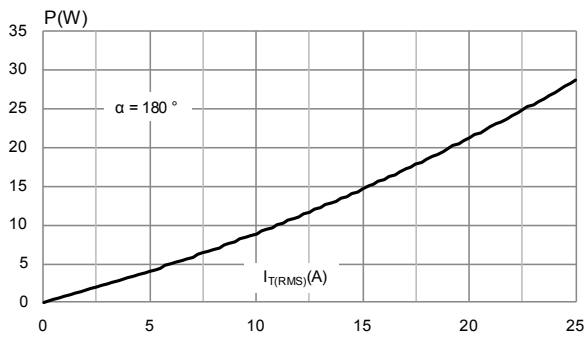

Figure 2. On-state RMS current versus case temperature (full cycle)

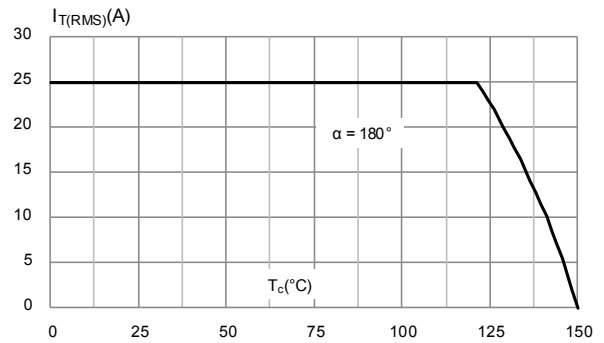

Figure 3. On-state RMS current versus ambient temperature (free air convection)

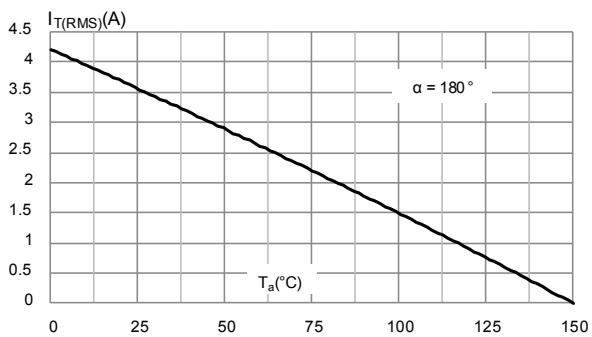

Figure 4. On-state characteristics (maximum)

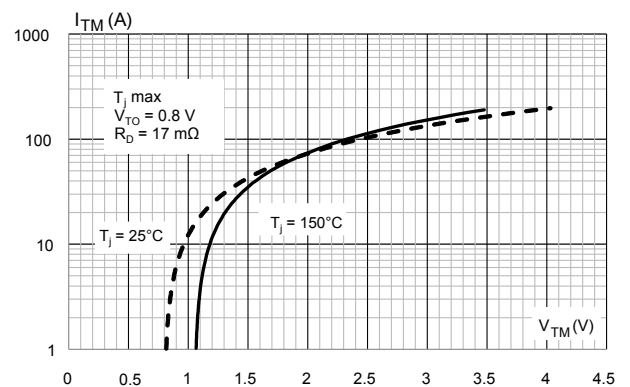

Figure 5. Relative variation of I_{GT}, I_H, I_L vs junction temperature (typical values)

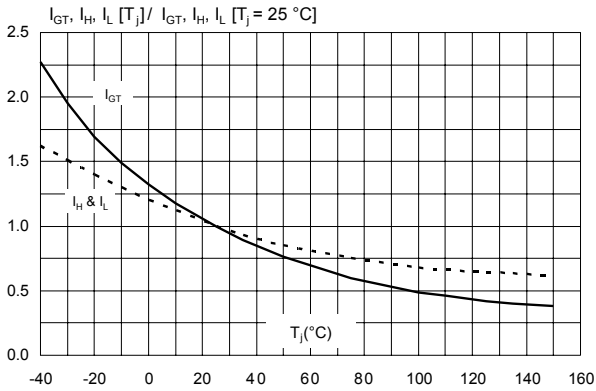

Figure 6. Relative variation of critical rate of decrease of main current versus junction temperature

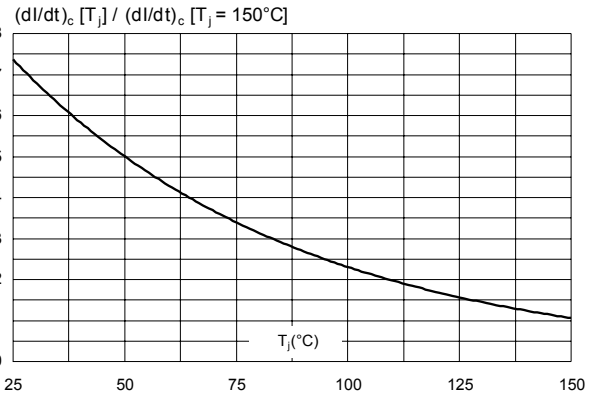

Figure 7. Relative variation of critical rate of decrease of current $(di/dt)_c$ versus reapplied $(dV/dt)_c$

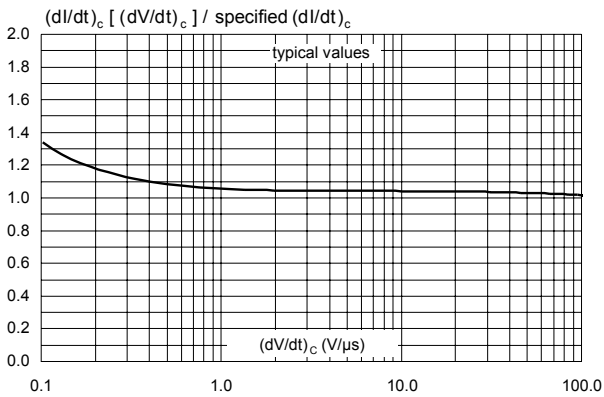

Figure 8. Surge peak on-state current versus number of cycles

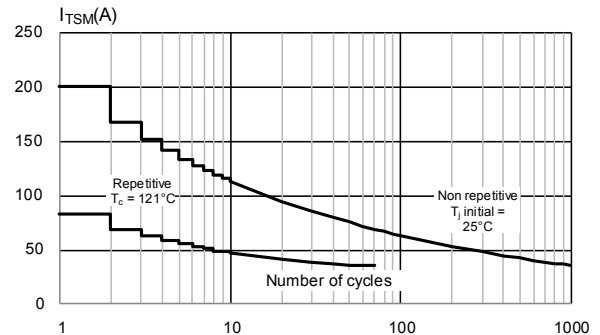

Figure 9. Non repetitive surge peak on-state current for a sinusoidal pulse width $t_p < 10$ ms

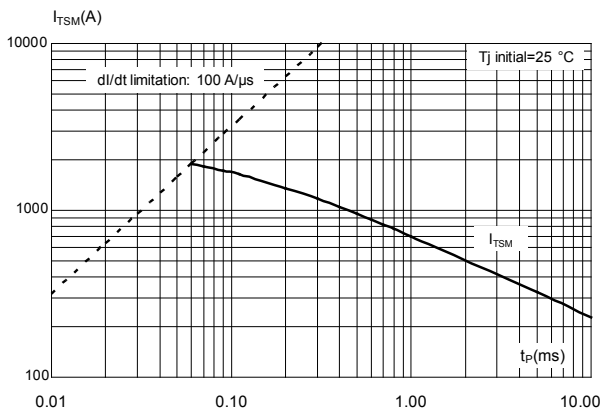

Figure 10. Relative variation of thermal impedance versus pulse duration

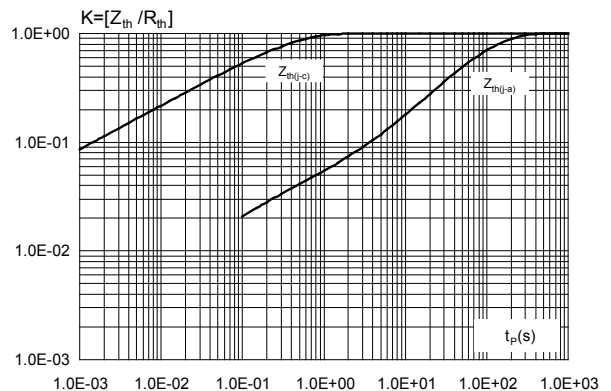
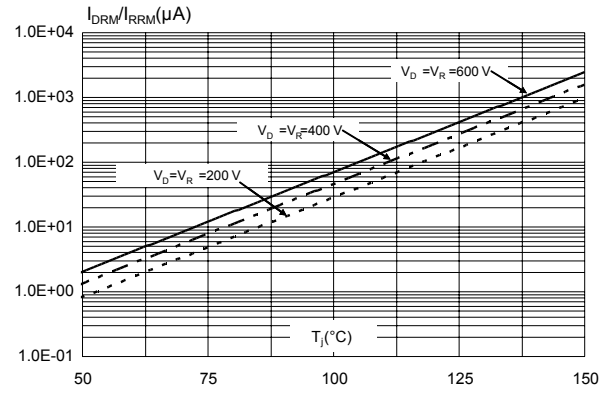

Figure 11. Leakage current versus junction temperature for different values of blocking voltage (typical values)



2 Package information

In order to meet environmental requirements, ST offers these devices in different grades of **ECOPACK** packages, depending on their level of environmental compliance. ECOPACK specifications, grade definitions and product status are available at: www.st.com. ECOPACK is an ST trademark.

2.1 D²PAK package information

- **ECOPACK2** compliant
- Lead-free package leads finishing
- Molding compound resin is halogen-free and meets UL94 flammability standard level V0

Figure 12. D²PAK package outline

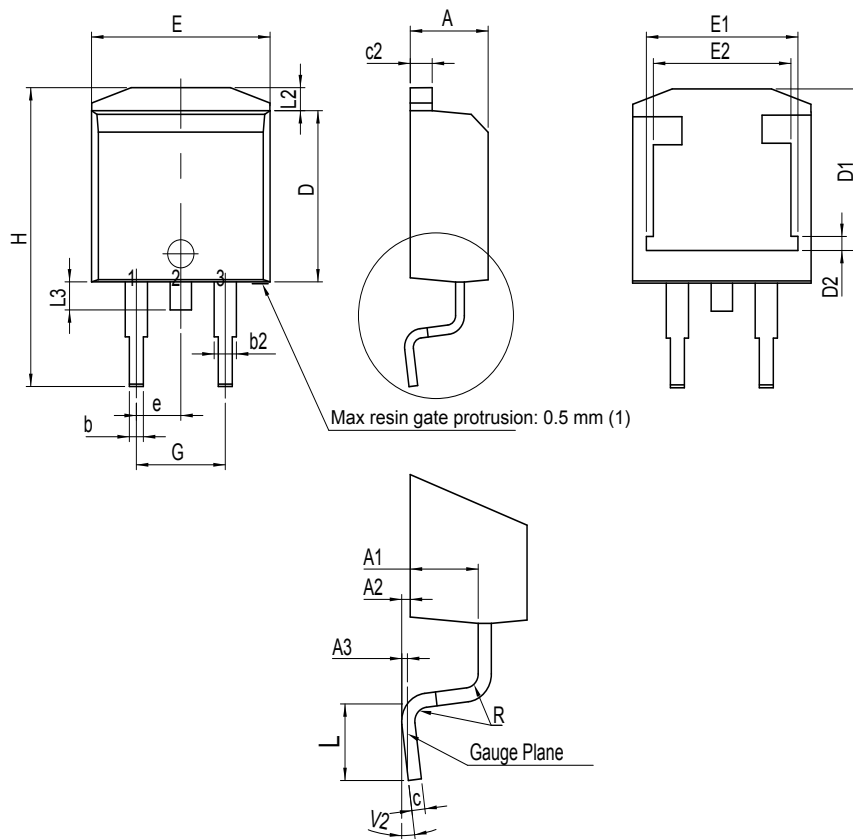

(1) Resin gate is accepted in each of position shown on the drawing, or their symmetrical.

Table 5. D²PAK package mechanical data

Ref.	Dimensions					
	Millimeters			Inches ⁽¹⁾		
	Min.	Typ.	Max.	Min.	Typ.	Max.
A	4.30		4.60	0.1693		0.1811
A1	2.49		2.69	0.0980		0.1059
A2	0.03		0.23	0.0012		0.0091
A3		0.25			0.0098	
b	0.70		0.93	0.0276		0.0366
b2	1.25		1.7	0.0492		0.0669
c	0.45		0.60	0.0177		0.0236
c2	1.21		1.36	0.0476		0.0535
D	8.95		9.35	0.3524		0.3681
D1	7.50		8.00	0.2953		0.3150
D2	1.30		1.70	0.0512		0.0669
e	2.54			0.10000		
E	10.00		10.28	0.3937		0.4047
E1	8.30		8.70	0.3268		0.3425
E2	6.85		7.25	0.2697		0.2854
G	4.88		5.28	0.1921		0.2079
H	15		15.85	0.5906		0.6240
L	1.78		2.28	0.0701		0.0898
L2	1.19		1.40	0.0460		0.0551
L3	1.40		1.75	0.0551		0.0689
R		0.40			0.0157	
V2 ⁽²⁾	0°		8°	0°		8°

1. Dimensions in inches are given for reference only

2. Degrees

Figure 13. D²PAK recommended footprint (dimensions are in mm)

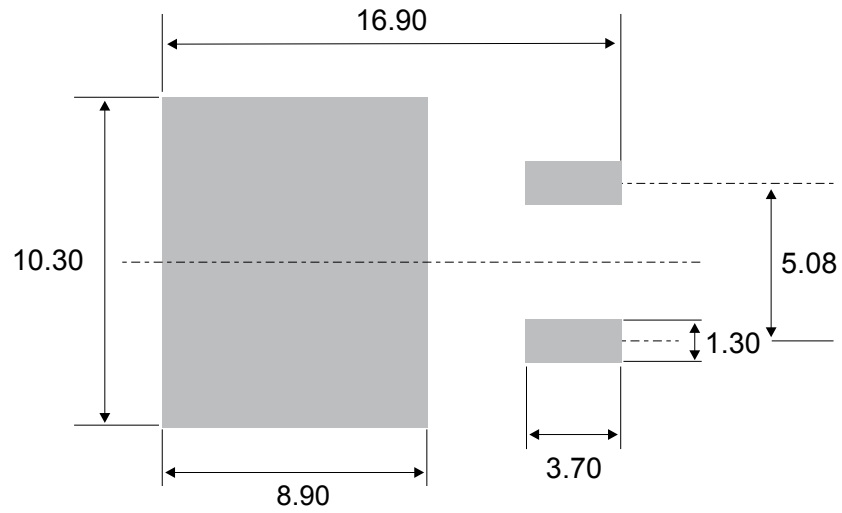
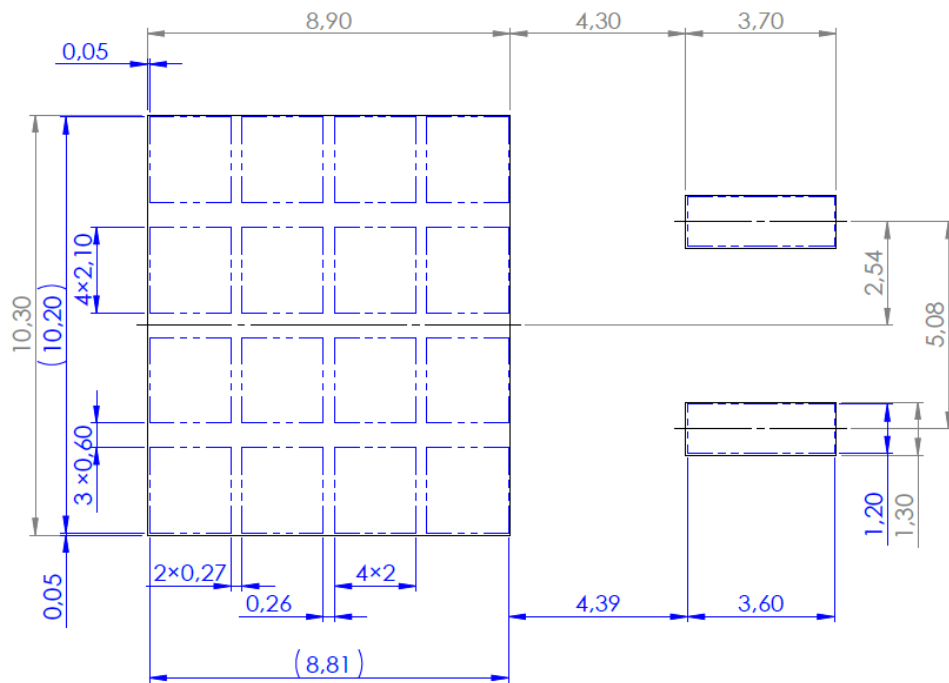

Figure 14. D²PAK stencil definitions (dimensions are in mm)



3 Ordering information

Figure 15. Ordering information scheme

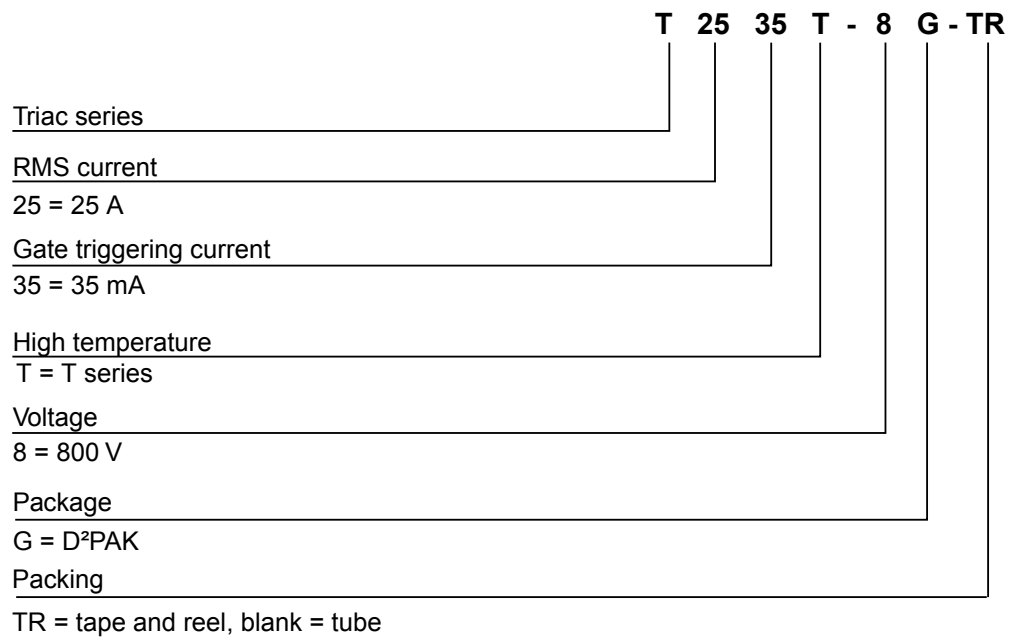

Table 6. Ordering information

Order code	Marking	Package	Weight	Base Qty.	Delivery mode
T2535T-8G	T2535T-8G	D ² PAK	1.6 g	50	Tube
T2535T-8G-TR	T2535T-8G			2500	Tape and reel

Revision history

Table 7. Document revision history

Date	Version	Changes
23-Sep-2020	1	Initial release.

IMPORTANT NOTICE – PLEASE READ CAREFULLY

STMicroelectronics NV and its subsidiaries (“ST”) reserve the right to make changes, corrections, enhancements, modifications, and improvements to ST products and/or to this document at any time without notice. Purchasers should obtain the latest relevant information on ST products before placing orders. ST products are sold pursuant to ST’s terms and conditions of sale in place at the time of order acknowledgement.

Purchasers are solely responsible for the choice, selection, and use of ST products and ST assumes no liability for application assistance or the design of Purchasers’ products.

No license, express or implied, to any intellectual property right is granted by ST herein.

Resale of ST products with provisions different from the information set forth herein shall void any warranty granted by ST for such product.

ST and the ST logo are trademarks of ST. For additional information about ST trademarks, please refer to www.st.com/trademarks. All other product or service names are the property of their respective owners.

Information in this document supersedes and replaces information previously supplied in any prior versions of this document.

© 2020 STMicroelectronics – All rights reserved