

NCP10970BGEVB



ON Semiconductor®

www.onsemi.com

Dual Output (with 5 V LDO) PSU for High Voltage Input Evaluation Board User's Manual

DESCRIPTION

The NCP10970BGEVB evaluation board is a non-isolated buck topology converter which provides adjustable output voltage up to 16 V and fixed linear output voltage 5 V. Input voltage range is from ~30 V_{rms} up to 440 V_{rms}. The board is also ready for DC input voltage up to 620 V.

Nominal output current of the board is 150 mA. This current is divided between switcher output and LDO output, i.e. when LDO provides 100 mA of output current, there is 50 mA on switcher output.

The NCP10970B1 is SOIC-16 power management IC combines HV switcher, LDO, internal circuitry for creating the input voltage for LDO in very effective way and internal comparator circuitry. The switcher works in a DCM mode for better efficiency, EMI and surge robustness. To ensure low no-load standby power and good efficiency at light load, the device is equipped with a skip mode operation.

A dedicated comparator circuitry provides a means to instruct the external control section that an over-temperature or over-current point has been reached. The comparator input is biased by a precise constant current source and output is an open-drain type. The speed of comparator is driven by a voltage value on STBY pin.

EVAL BOARD USER'S MANUAL

KEY FEATURES

- Wide Input Voltage Range up to 440 V_{rms}
- Adjustable Output Voltage up to 16 V
- Fixed Linear Output Voltage 5 V
- High Efficiency
- Complies with CoC5 Tier2
- Low EMI Emissions
- Over-Current Protection
- Over-Voltage Protection
- Internal TSD Protection
- Integrated Comparator

Table 1. GENERAL PARAMETERS

| Device | Applications | Input Voltage | Output Voltage / Current | V _{OUT} Ripple | I/O Isolation |
|---|--|----------------------------|---|-------------------------|---------------|
| NCP10970B1 | White goods, IoT devices, E-metering applications, power sources driven by MCU | Up to 440 V _{rms} | 15 V switcher output 5 V LDO output 150 mA shared between 15 V and 5 V output | < 100 mV | Non-isolated |
| Efficiency | No-load Input Power | Operating Temperature | Cooling | Topology | Board Size |
| see efficiency graphs and table in page 4 | 30 mW @ 115 V _{rms} 40 mW @ 230 V _{rms} 64 mW @ 600 V | 0 – 50°C | Passive cooling | Buck | 68 x 37 mm |

NCP10970BGEVB

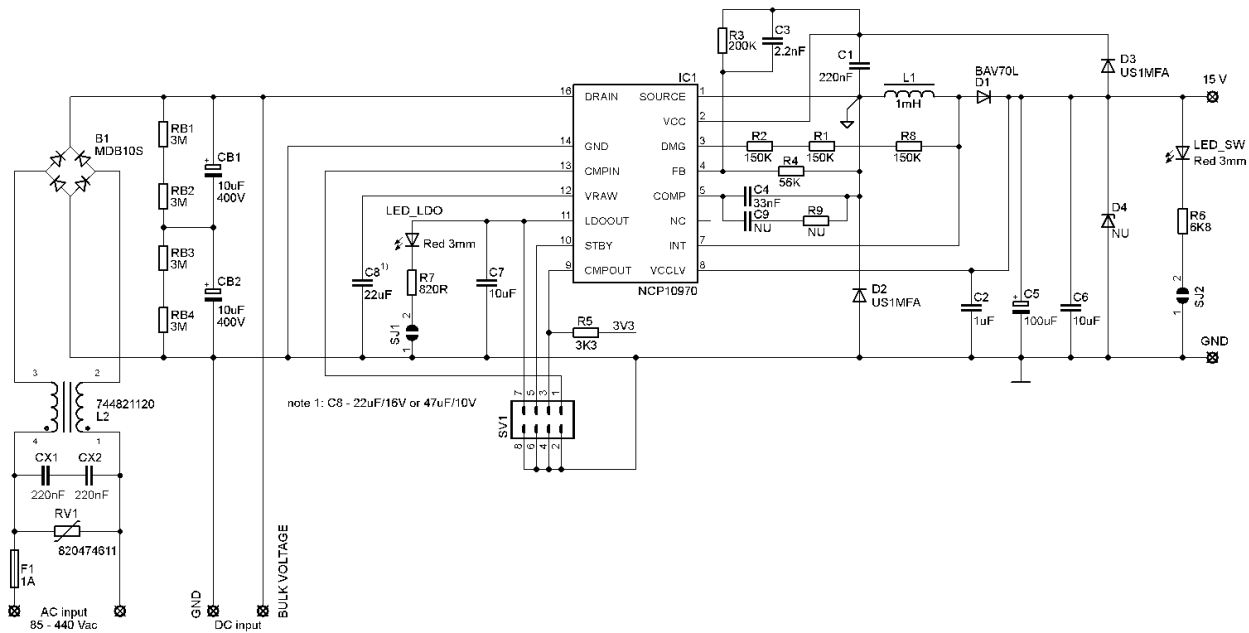

Figure 1. Schematic Diagram of NCP10970BGEVB Board

DETAILED DESCRIPTIONS OF THE EVALUATION BOARD

The 1 A time-lag fuse, to withstand the inrush current, protects the input of the converter. There is also the varistor RV_1 placed behind the fuse as a differential mode lighting surge protection.

The EMI filter consists from the common-mode power line choke L_2 and X-capacitors CX_1 and CX_2 connected in series to withstand the high input voltage.

The power stage is a buck topology and it consists of the bridge rectifier B_1 , bulk capacitors CB_1 and CB_2 with voltage balancing resistors RB_1 – RB_4 , switcher in IC_1 , inductor L_1 , diodes D_1 and D_2 and output capacitors C_5 with decoupling ceramic capacitor C_6 .

The voltages on all pins of switcher IC_1 (pin 1 to 5 and pin 16) are related to SOURCE pin, which is common ground of the switcher.

The output voltage is controlled based on the portion of the output voltage on FB pin from resistor divider R_3 and R_4 through diode D_3 . The voltage on resistor R_4 is compared with internal reference voltage $V_{REF} = 3.3$ V.

Capacitor C_3 in parallel to resistor R_3 makes the feedback loop faster.

The supply capacitor C_1 connected to VCC pin ensures the stability of the switcher supply voltage. Its value also affects the switching behavior of the switcher. It means, low value bring faster response but causes high output voltage during no-load as well.

The capacitor C_4 connected to COMP pin creates a type I compensation network, i.e. the value affects the gain and phase margin of the feedback loop.

Sensing signal of the end of the inductor demagnetization is connected to DGM pin through resistors R_1 , R_2 and R_8 . These resistors have to withstand the voltage of input power

source and reduce the maximum current value to 2 mA during on-time. During off-time, these resistors R_1 , R_2 and R_8 create a resistor divider with 47 k Ω internal resistor R_{int} .

The Zener diode D_4 is prepared to clamp output voltage when it is needed, otherwise high output voltage causes Over-Voltage Protection on VCC pin.

The low-voltage part of the IC_1 is supplied via VCCLV pin with connected ceramic capacitor C_2 for better decoupling from output voltage. This capacitor also provides stability of supply voltage when the internal switch connected to VCCLV pin supplies the input of the LDO regulator.

VRAW pin is the input of the LDO regulator. The current is transferred from inductor L_1 through INT pin and internal switch to the capacitor C_8 connected to VRAW pin. The capacitor C_8 determines the ripple of VRAW voltage and provides the energy during skip mode operation of switcher – no switching pulses, i.e. the energy for LDO cannot be transferred through INT switch. Therefore, it is recommended to use capacitor with X7R dielectric and 22 μ F / 16 V as minimum value or 47 μ F / 10 V.

The capacitor C_7 connected to LDOOUT pin ensures the stability and performance during normal operation and load transients on LDO rail. The PSRR performance based on capacitor C_7 value is shown in datasheet.

The indication of presence of output voltages providing the red LEDs connected to the outputs through solder jumpers SJ_1 and SJ_2 .

CMPIN pin is the input pin of the integrated comparator. This pin is biased by a precise internal 120 μ A current source – the over-temperature detection can be realized with PTC thermistor connected to this pin. The 100 nF capacitor can be connected in parallel to PTC thermistor for better behavior of over-temperature detection.

NCP10970BGEVB

The output of the comparator CMPOUT pin crosses from High Z state to low state when voltage on CMPIN pin achieves 1 V. The output goes back to High Z state when voltage on CMPIN pin drops below 0.8 V. Detailed explanation of comparator is stated in datasheet.

STBY pin drives the speed of the comparator. The comparator is slow (300 ns delay) when this pin is grounded

and fast (70 ns delay) when 3 V and more is connected to this pin – 5.5 V is maximum allowed voltage. The input of the STBY pin is internally grounded through 100 kΩ resistor.

PCB LAYOUT

The PCB is made as a double layer FR4 board with 35 μm copper cladding.

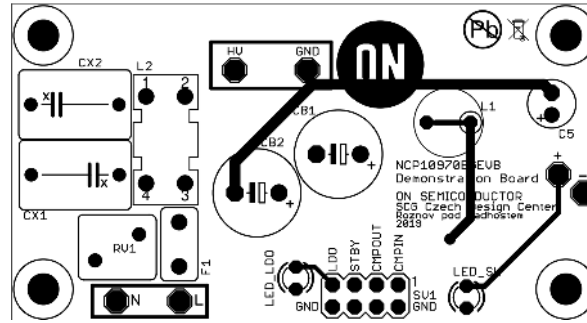

Figure 2. NCP10970BGEVB – Top Side Layer + Components

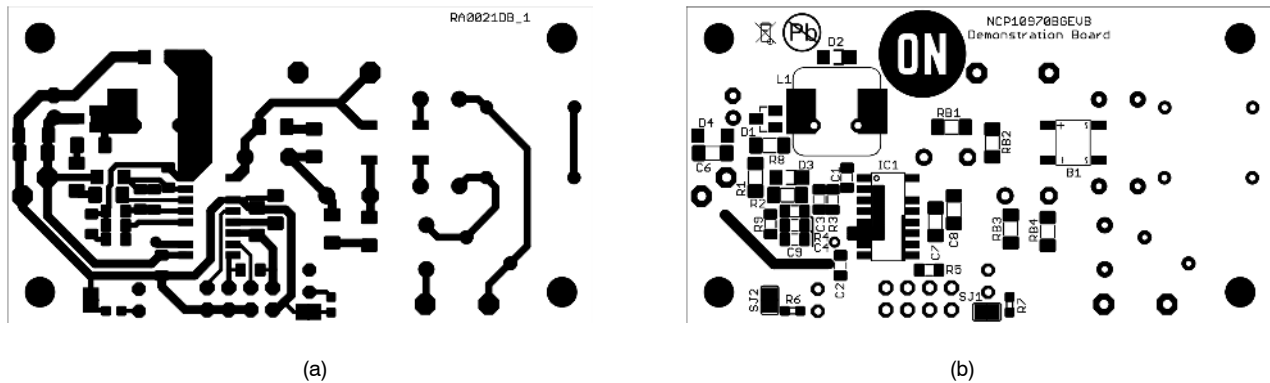

Figure 3. NCP10970BGEVB – Bottom Side – (a) Layer, (b) Components

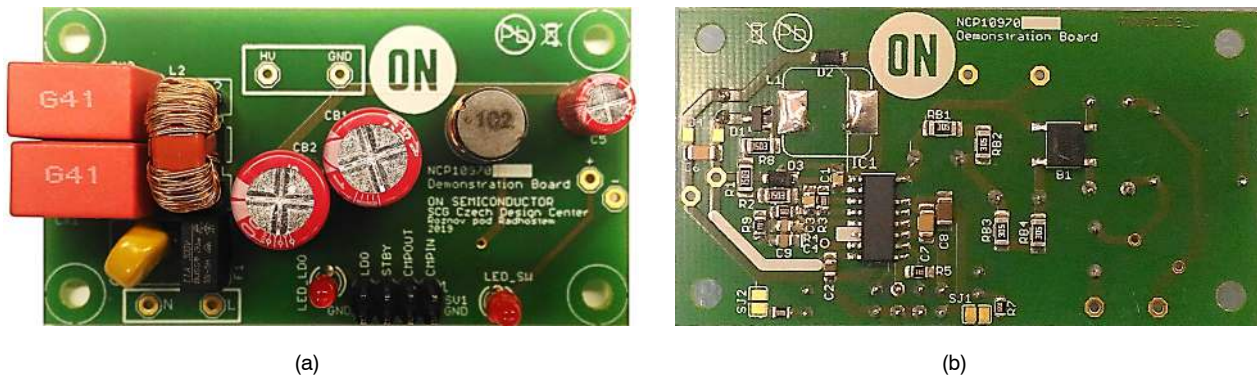

Figure 4. NCP10970BGEVB Board Photo – (a) Top Side, (b) Bottom Side

NCP10970BGEVB

MEASUREMENTS – GRAPHS AND TABLES

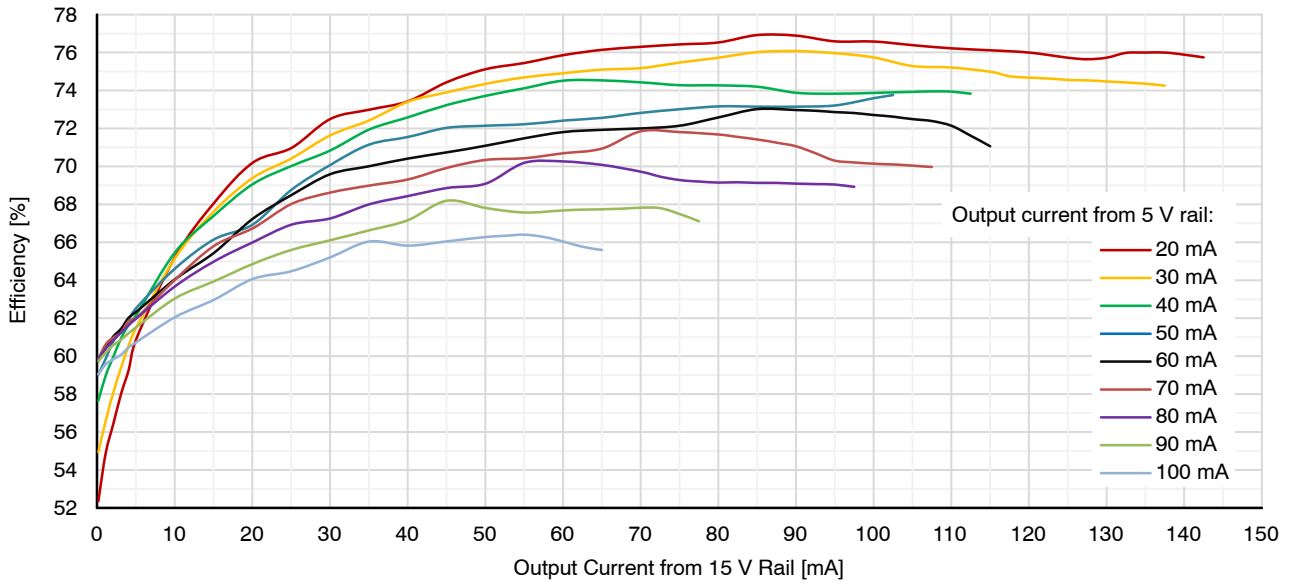

Figure 5. Efficiency Graph of NCP10970BGEVB for 115 V_{rms} / 60 Hz

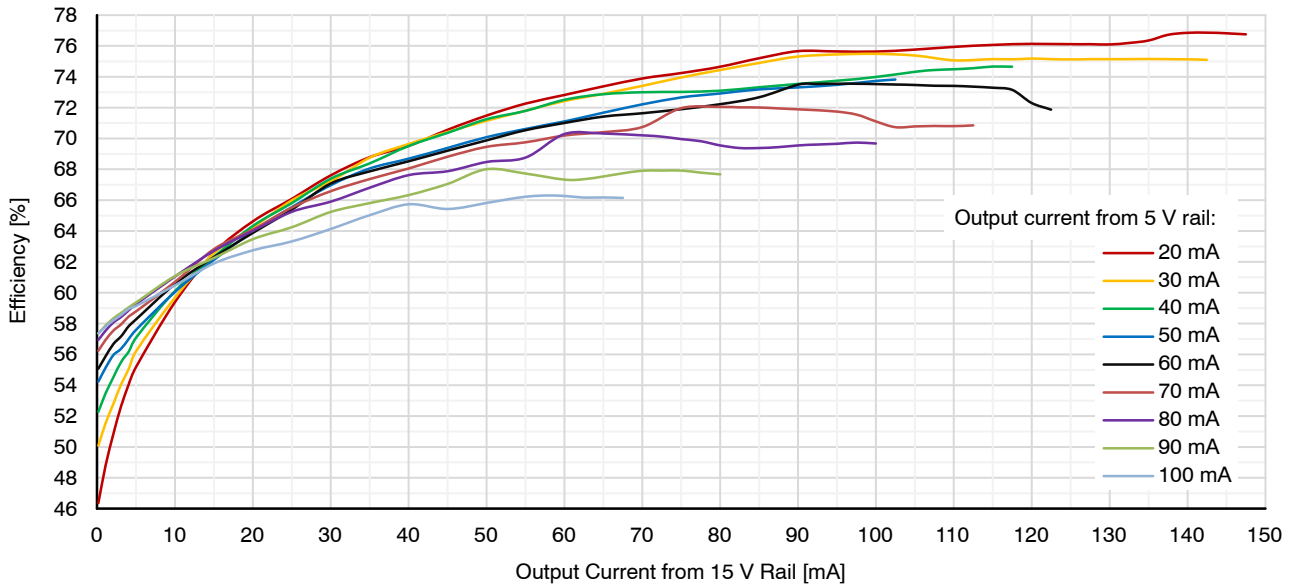

Figure 6. Efficiency Graph of NCP10970BGEVB for 230 V_{rms} / 50 Hz

Table 2. EFFICIENCY TABLE

| Output Load | Input Voltage | | |
|---|---------------|---------------|-------|
| | 115 V_{rms} | 230 V_{rms} | 600 V |
| $I_{OUT} = 15 \text{ mA}$, $I_{LDOOUT} = 30 \text{ mA}$ | 67.5% | 62.3% | 55.5% |
| $I_{OUT} = 15 \text{ mA}$, $I_{LDOOUT} = 60 \text{ mA}$ | 65.5% | 62.1% | 55.1% |
| $I_{OUT} = 15 \text{ mA}$, $I_{LDOOUT} = 80 \text{ mA}$ | 64.7% | 56.8% | 65.3% |
| $I_{OUT} = 15 \text{ mA}$, $I_{LDOOUT} = 100 \text{ mA}$ | 63.1% | 61.8% | 58.2% |
| $I_{OUT} = 30 \text{ mA}$, $I_{LDOOUT} = 100 \text{ mA}$ | 65.6% | 64.1% | 59.8% |
| $I_{OUT} = 50 \text{ mA}$, $I_{LDOOUT} = 100 \text{ mA}$ | 66.2% | 65.8% | 61.9% |

NCP10970BGEVB

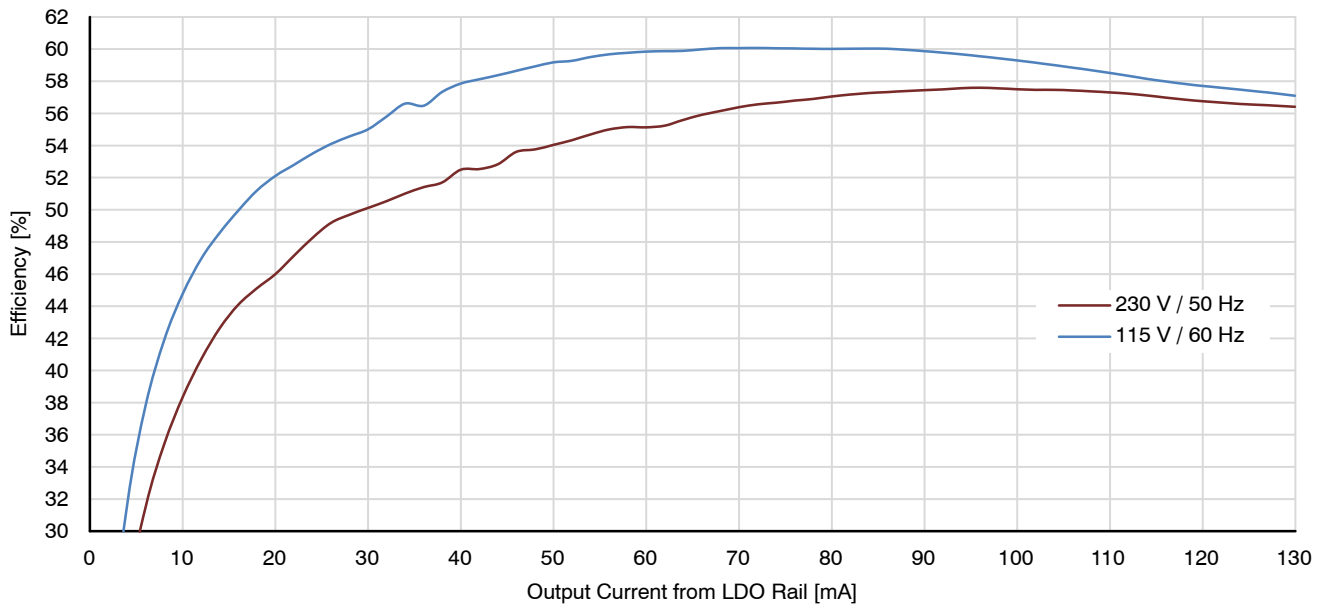

Figure 7. Efficiency Graph of NCP10970BGEVB as HV LDO – the 15 V Rail is not Loaded

Table 3. NO-LOAD INPUT POWER TABLE

| Input Voltage | No-load Input Power $I_{OUT} = \text{Unloaded}$ $I_{LDOOUT} = \text{Unloaded}$ | Application Standby $I_{OUT} = 0.5 \text{ mA}$ $I_{LDOOUT} = 3 \text{ mA}$ |
|---------------|--|--|
| 115 V_{rms} | 30 mW | 68 mW |
| 230 V_{rms} | 40 mW | 82 mW |
| 400 V | 44 mW | 85 mW |
| 600 V | 64 mW | 107 mW |

*115/230 V_{rms} was applied on AC input terminals, 400/600 V was applied on DC input terminals

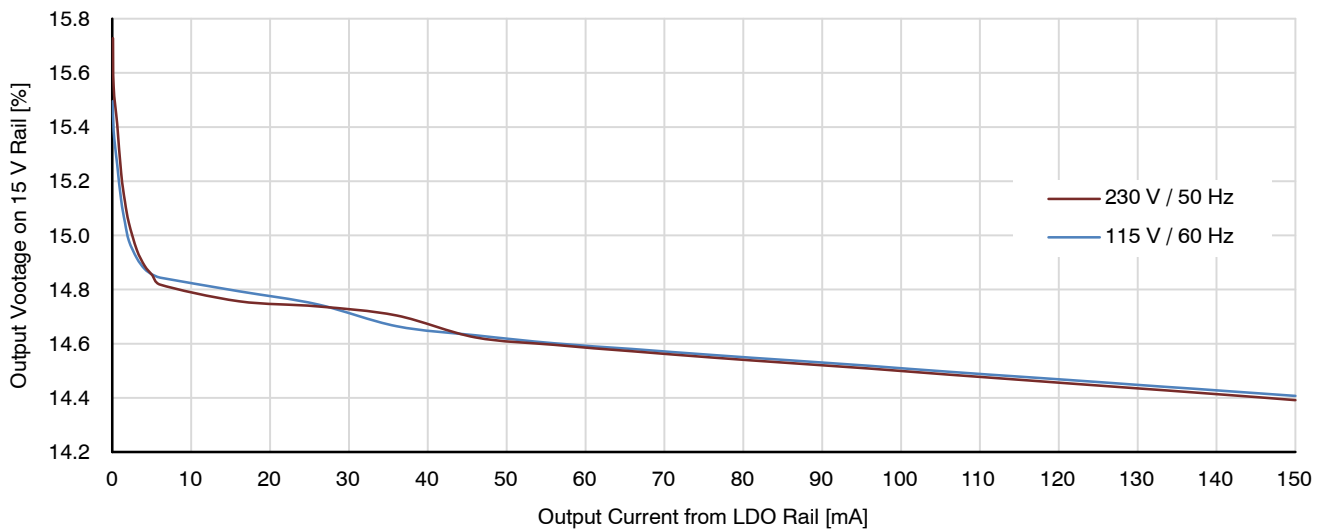

Figure 8. Output Voltage Regulation of NCP10970BGEVB

NCP10970BGEVB

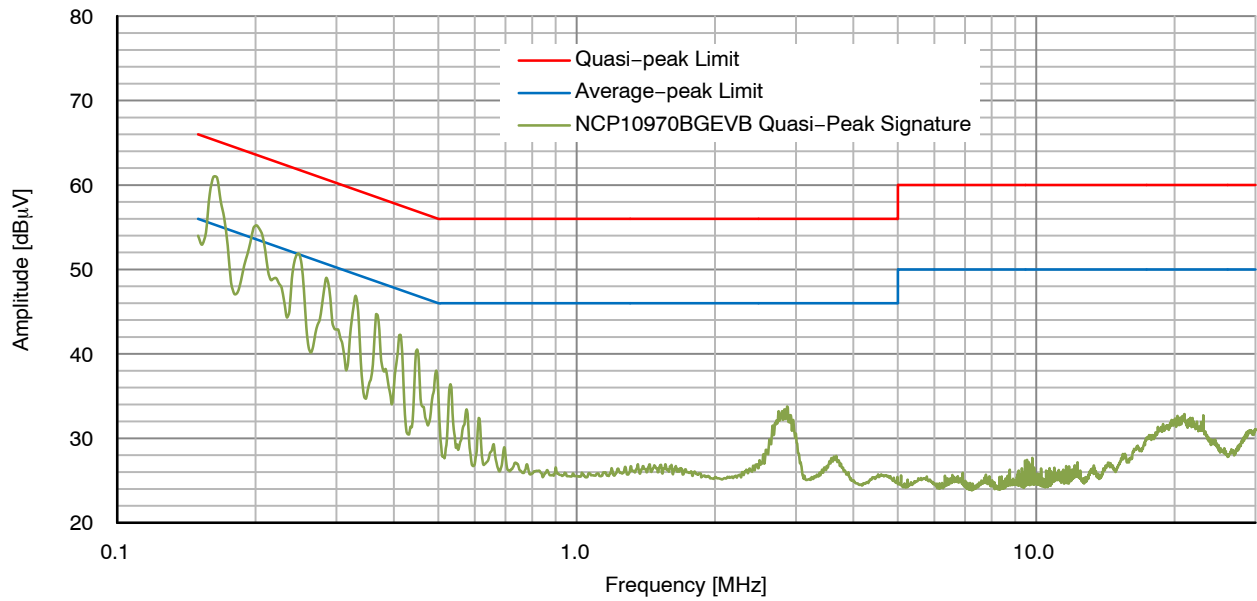

Figure 9. Quasi-Peak EMI Measurement NCP10970BGEVB, $V_{IN} = 230 V_{rms}$, $I_{OUT} = 44 mA$, $I_{LDOOUT} = 94 mA$

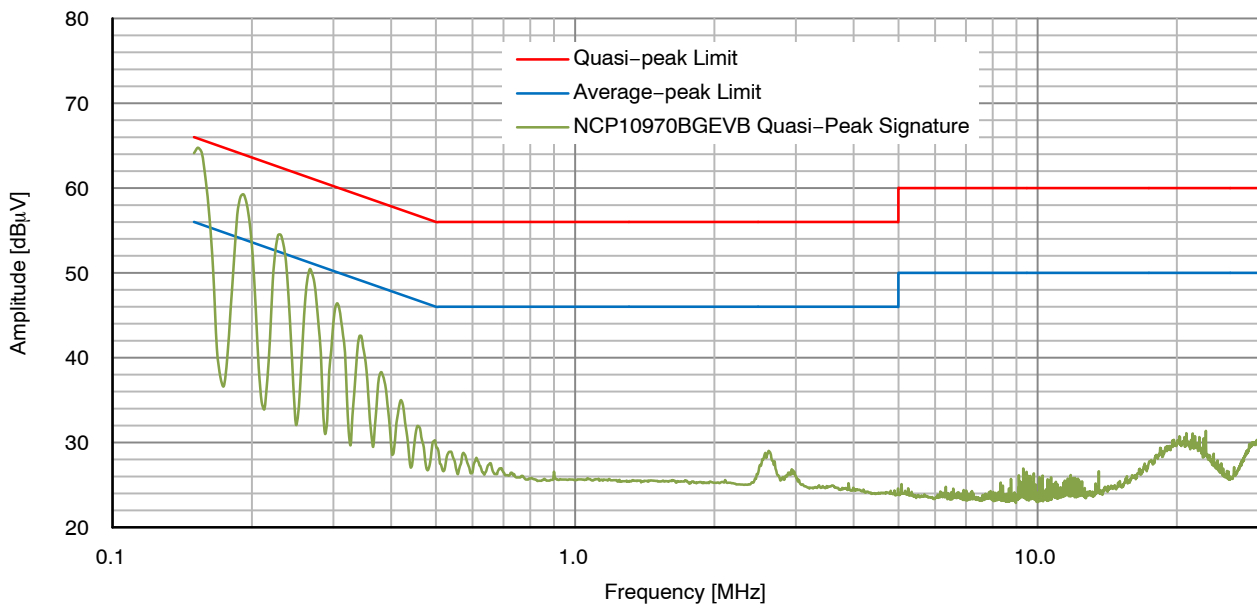

Figure 10. Quasi-Peak EMI Measurement NCP10970BGEVB, $V_{IN} = 115 V_{rms}$, $I_{OUT} = 44 mA$, $I_{LDOOUT} = 94 mA$

MEASUREMENTS – WAVEFORMS

Startup and Power-down Behavior

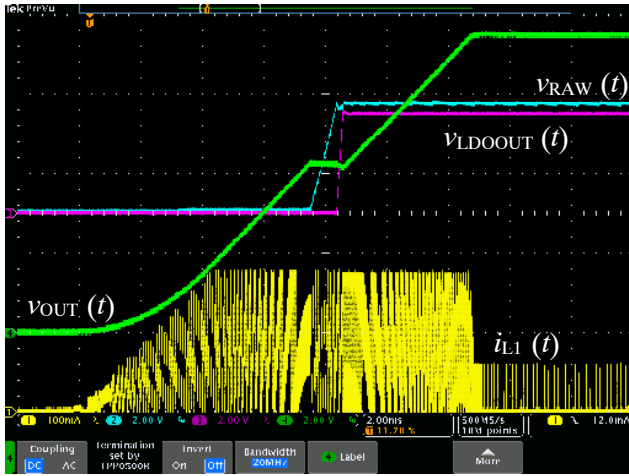

Figure 11. Startup at $V_{IN} = 115\text{ V}$, $I_{OUT} = I_{LDOOUT} = \text{Unloaded}$

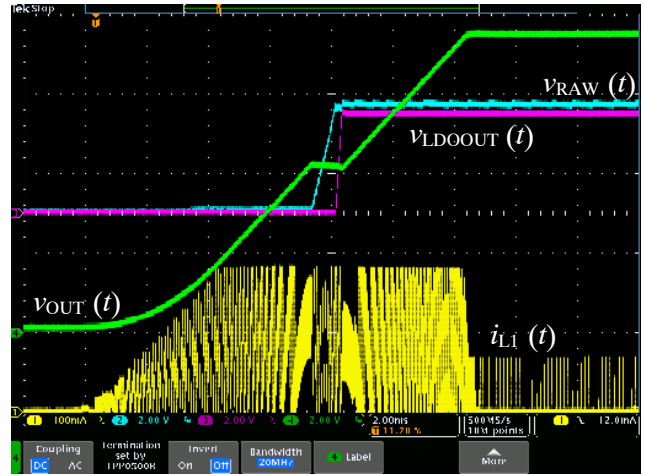

Figure 12. Startup at $V_{IN} = 230\text{ V}$, $I_{OUT} = I_{LDOOUT} = \text{Unloaded}$

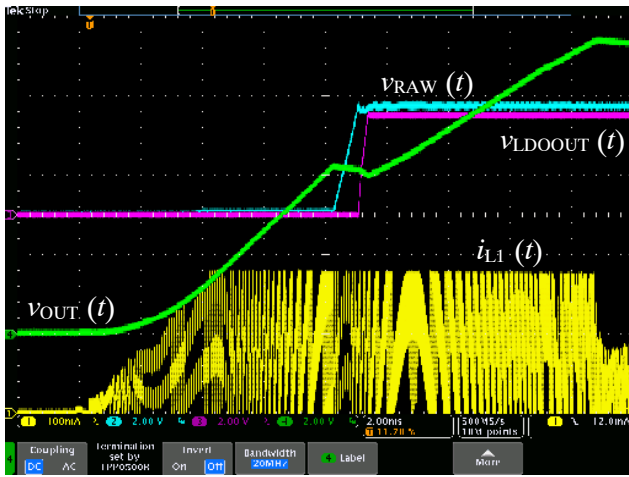

Figure 13. Startup at $V_{IN} = 115\text{ V}$, $I_{OUT} = 15\text{ mA}$, $I_{LDOOUT} = 60\text{ mA}$

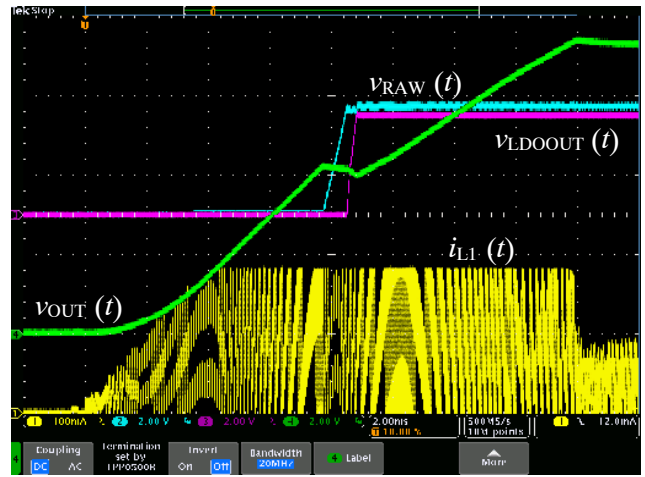

Figure 14. Startup at $V_{IN} = 230\text{ V}$, $I_{OUT} = 15\text{ mA}$, $I_{LDOOUT} = 60\text{ mA}$

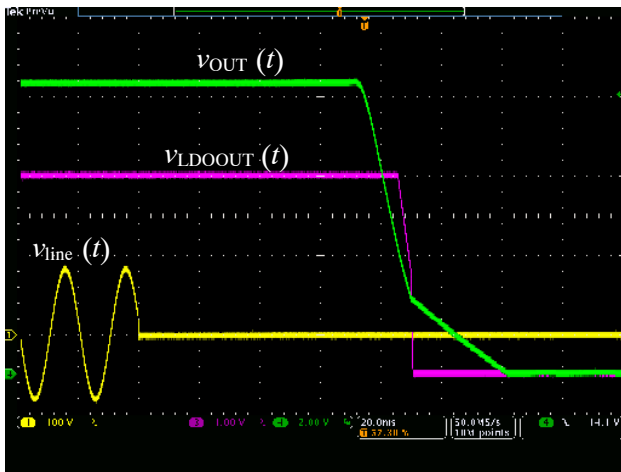

Figure 15. Power-down at $V_{IN} = 115\text{ V}$, $I_{OUT} = 15\text{ mA}$, $I_{LDOOUT} = 60\text{ mA}$; Outputs are in Regulation for 80 ms

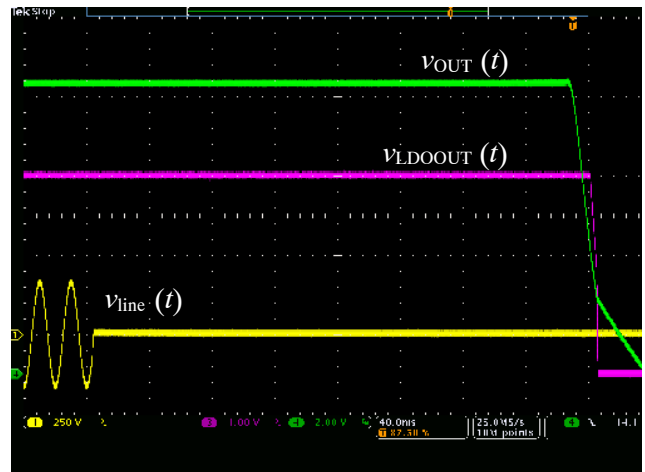

Figure 16. Power-down at $V_{IN} = 230\text{ V}$, $I_{OUT} = 15\text{ mA}$, $I_{LDOOUT} = 60\text{ mA}$; Outputs are in Regulation for 300 ms

Output Voltage Ripple

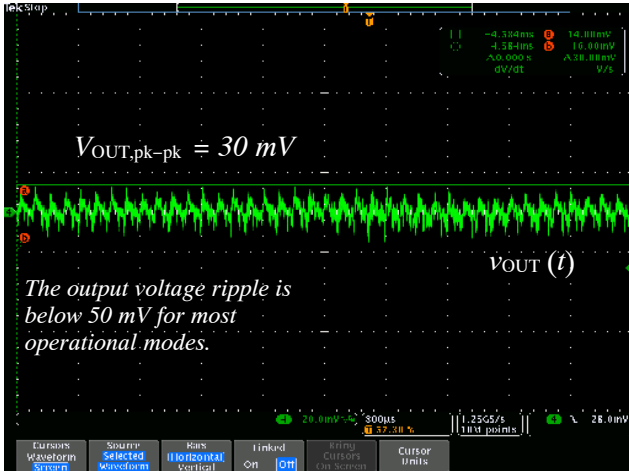

Figure 17. V_{OUT} Ripple for $V_{IN} = 115\text{ V}$, $I_{OUT} = 5\text{ mA}$, $I_{LDOOUT} = 30\text{ mA}$

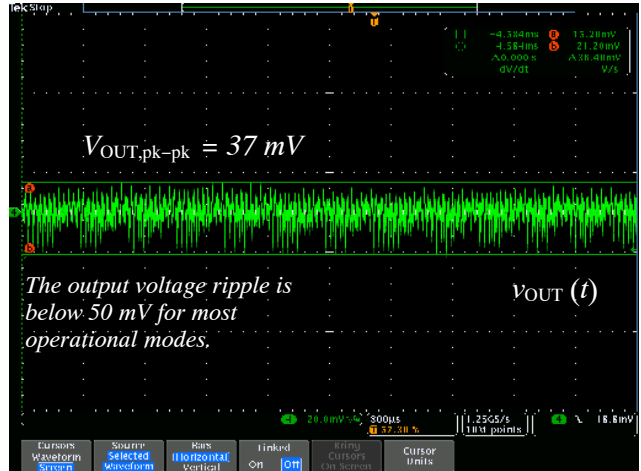

Figure 18. V_{OUT} Ripple for $V_{IN} = 230\text{ V}$, $I_{OUT} = 15\text{ mA}$, $I_{LDOOUT} = 60\text{ mA}$

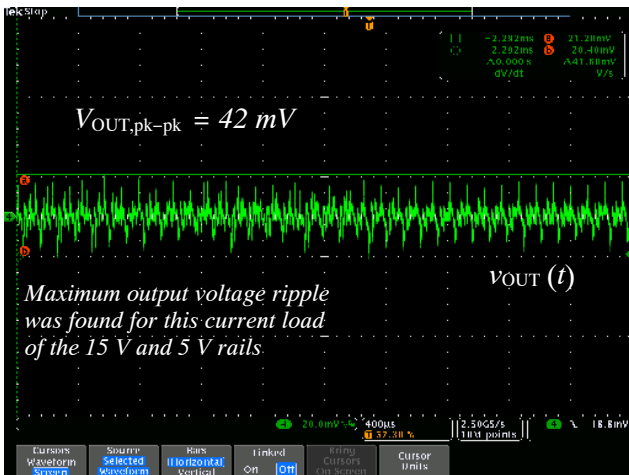

Figure 19. V_{OUT} Ripple for $V_{IN} = 115\text{ V}$, $I_{OUT} = 32\text{ mA}$, $I_{LDOOUT} = 90\text{ mA}$

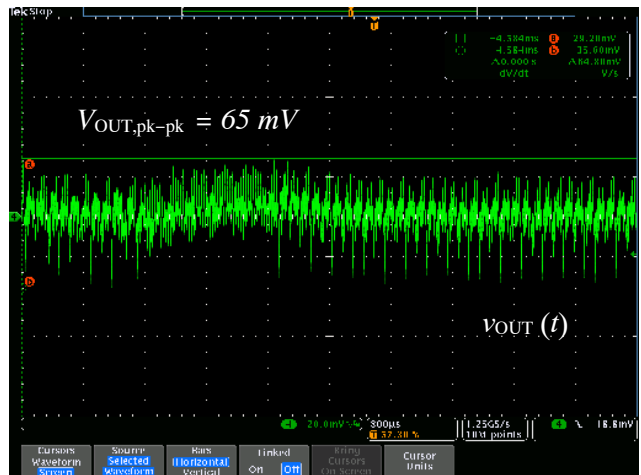

Figure 20. V_{OUT} Ripple for $V_{IN} = 230\text{ V}$, $I_{OUT} = 60\text{ mA}$, $I_{LDOOUT} = 76\text{ mA}$

Load Transient Response

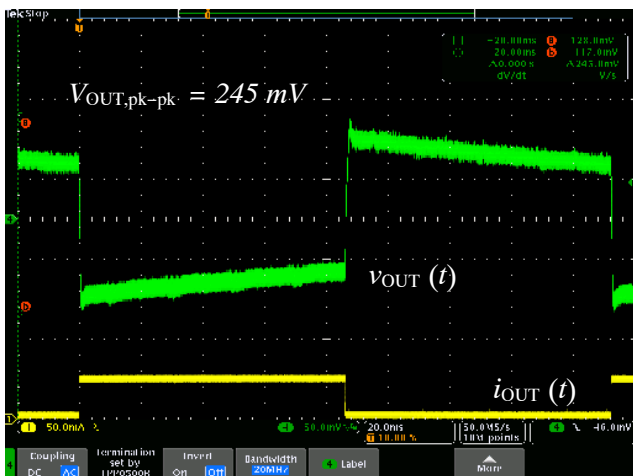

Figure 21. Response at $I_{OUT} = 5\text{ mA}$ to 50 mA , $I_{LDOOUT} = 30\text{ mA}$, $V_{IN} = 115\text{ V}$, Slew Rate $0.5\text{ A}/\mu\text{s}$

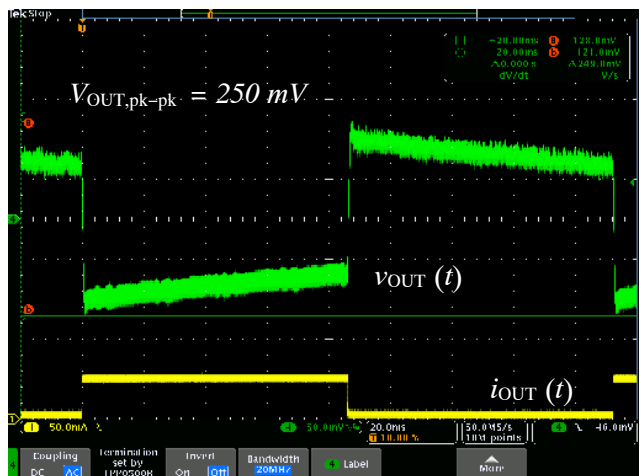

Figure 22. Response at $I_{OUT} = 5\text{ mA}$ to 50 mA , $I_{LDOOUT} = 30\text{ mA}$, $V_{IN} = 230\text{ V}$, Slew Rate $0.5\text{ A}/\mu\text{s}$

NCP10970BGEVB

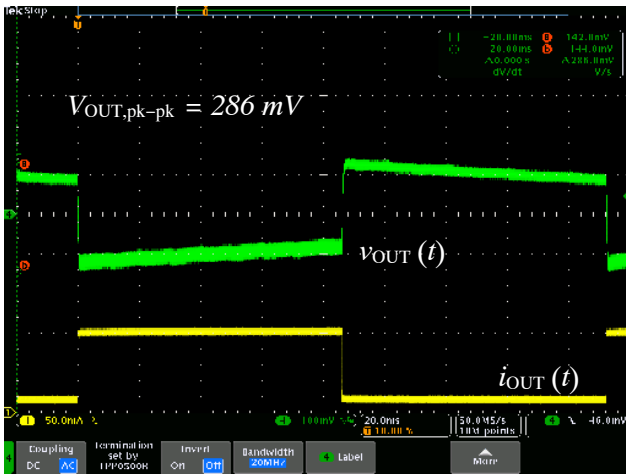

Figure 23. Response at $I_{OUT} = 15 \text{ mA}$ to 100 mA , $I_{LDOOUT} = 30 \text{ mA}$, $V_{IN} = 115 \text{ V}$, Slew Rate $0.5 \text{ A}/\mu\text{s}$

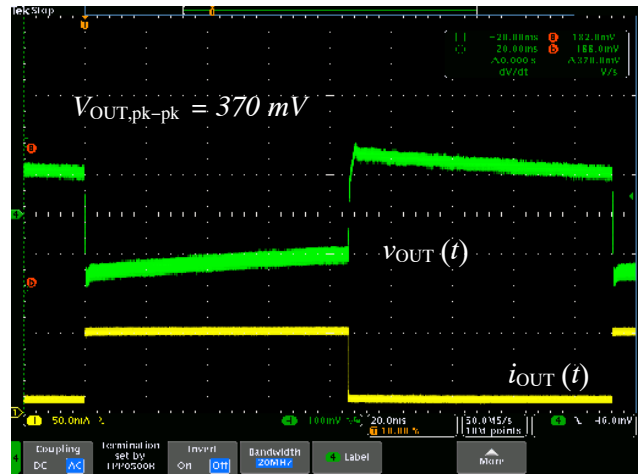

Figure 24. Response at $I_{OUT} = 15 \text{ mA}$ to 100 mA , $I_{LDOOUT} = 30 \text{ mA}$, $V_{IN} = 230 \text{ V}$, Slew Rate $0.5 \text{ A}/\mu\text{s}$

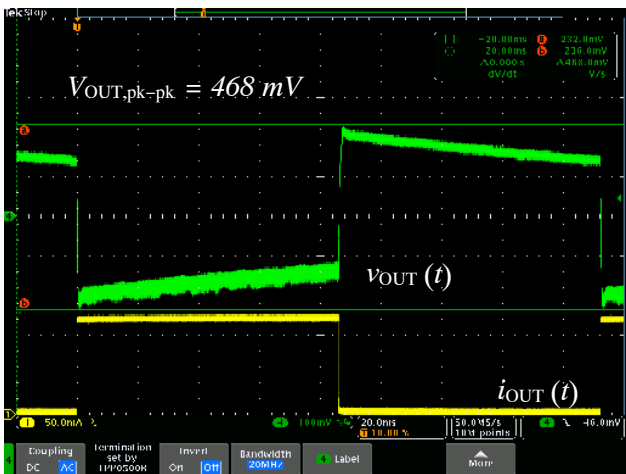

Figure 25. Response at $I_{OUT} = 2 \text{ mA}$ to 120 mA , $I_{LDOOUT} = 30 \text{ mA}$, $V_{IN} = 115 \text{ V}$, Slew Rate $0.5 \text{ A}/\mu\text{s}$

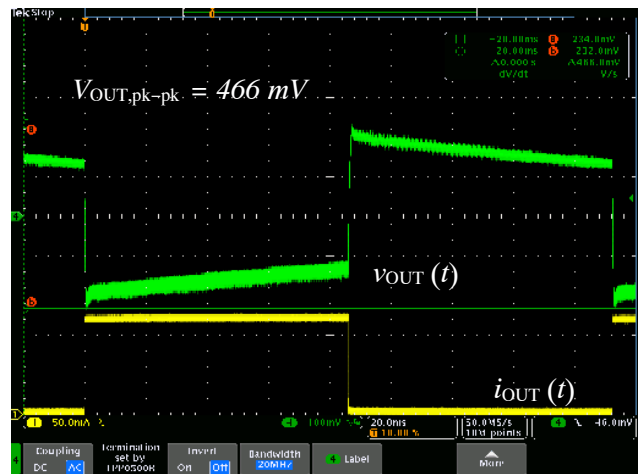

Figure 26. Response at $I_{OUT} = 2 \text{ mA}$ to 120 mA , $I_{LDOOUT} = 30 \text{ mA}$, $V_{IN} = 230 \text{ V}$, Slew Rate $0.5 \text{ A}/\mu\text{s}$

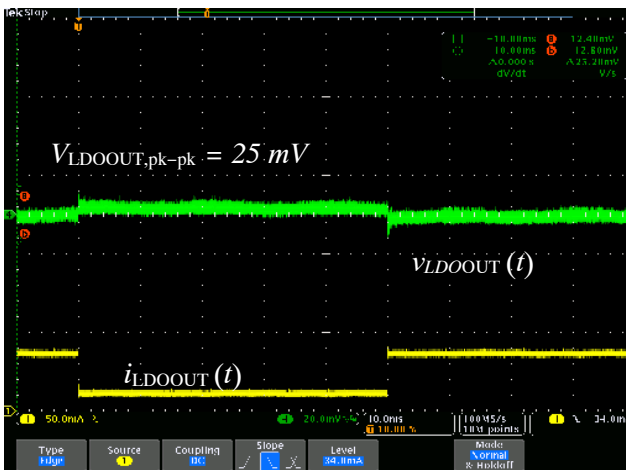

Figure 27. Response at $I_{LDOOUT} = 20 \text{ mA}$ to 75 mA , $I_{OUT} = 5 \text{ mA}$, $V_{IN} = 230 \text{ V}$, Slew Rate $0.5 \text{ A}/\mu\text{s}$

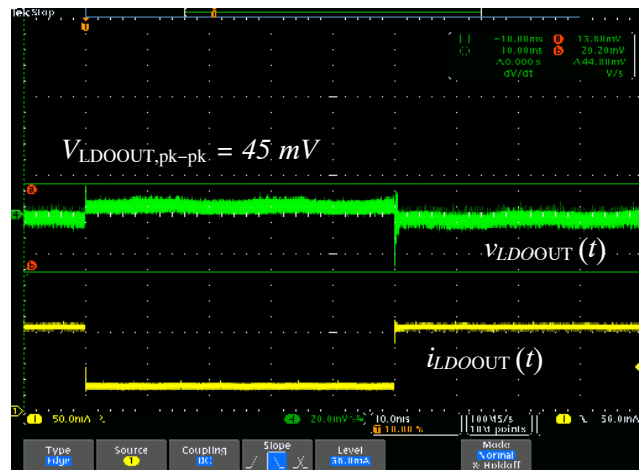

Figure 28. Response at $I_{LDOOUT} = 30 \text{ mA}$ to 108 mA , $I_{OUT} = 5 \text{ mA}$, $V_{IN} = 230 \text{ V}$, Slew Rate $0.5 \text{ A}/\mu\text{s}$

Protections

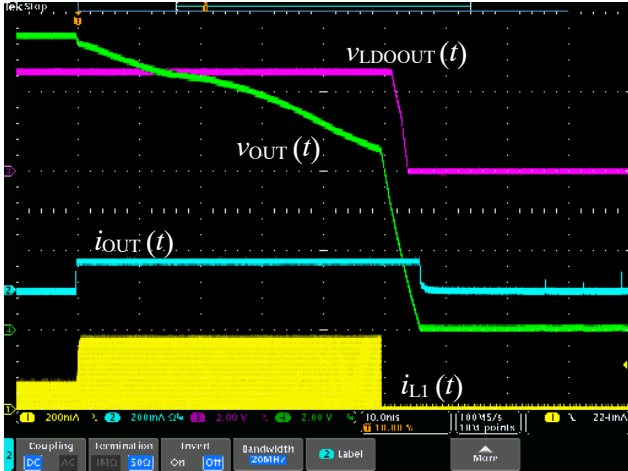

Figure 29. Timer-based Over-current Protection, $I_{OUT} = 5\text{mA}$ to 150mA , $I_{LDOOUT} = 30\text{mA}$, $V_{IN} = 230\text{V}$

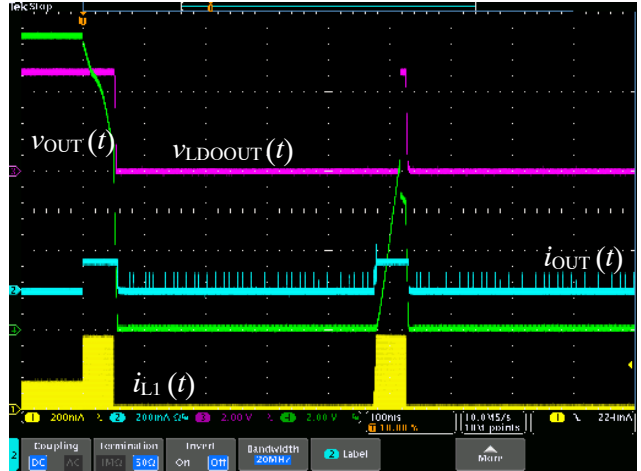

Figure 30. Auto-recovery Over-current Protection, $I_{OUT} = 150\text{mA}$, $I_{LDOOUT} = 30\text{mA}$, $V_{IN} = 230\text{V}$

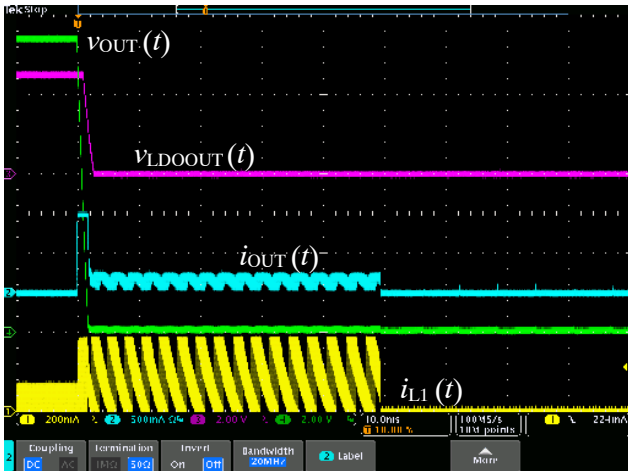

Figure 31. Timer-based Over-current Protection – Short Circuit, $I_{OUT} = \text{Short}$, $I_{LDOOUT} = 30\text{mA}$, $V_{IN} = 230\text{V}$

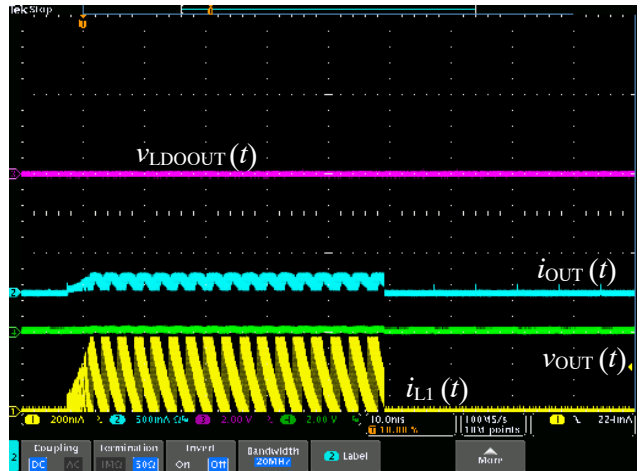

Figure 32. Short Circuit During Startup, $I_{OUT} = \text{Short}$, $I_{LDOOUT} = 30\text{mA}$, $V_{IN} = 230\text{V}$

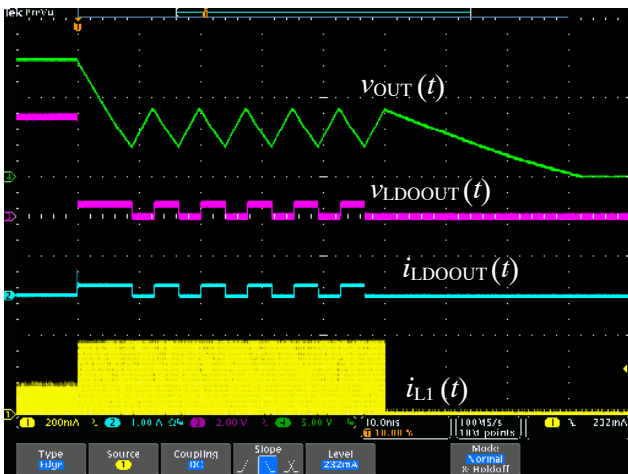

Figure 33. LDO Over-current Protection – Short Circuit on LDO Rail, $I_{OUT} = 30\text{mA}$, $I_{LDOOUT} = \text{Short}$, $V_{IN} = 230\text{V}$

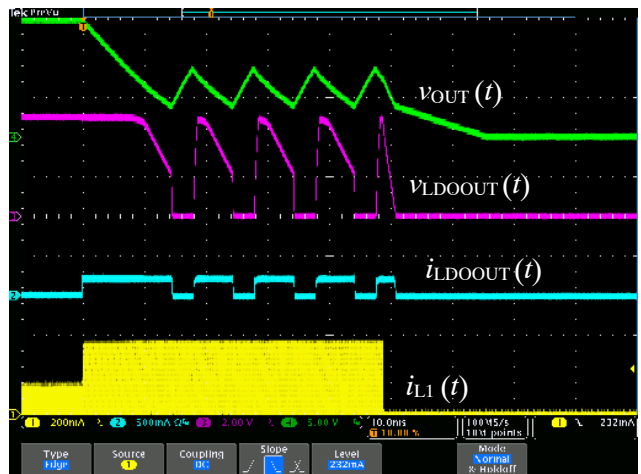

Figure 34. LDO Over-current Protection – Over-loaded LDO Rail, $I_{OUT} = 30\text{mA}$, $I_{LDOOUT} = 30$ to 200mA , $V_{IN} = 230\text{V}$

Comparator Behavior

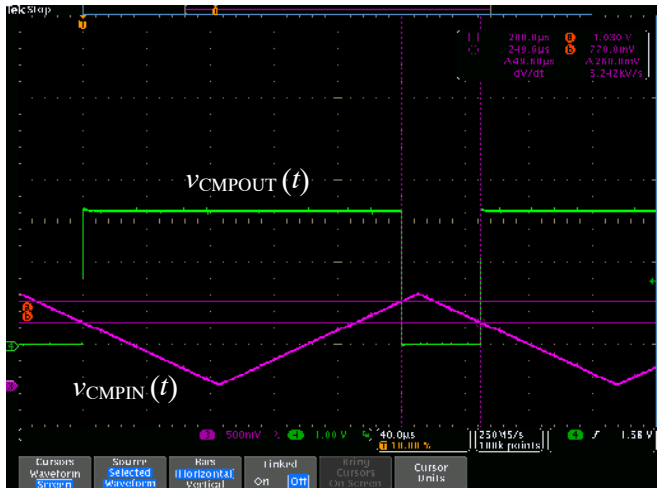

Figure 35. Comparator Behavior in Standby Mode, STBY Pin is Grounded

NCP10970BGEVB

Table 4. BILL OF MATERIALS

| QTY | Parts | Value | Tolerance | Package | Description | Manufacturer | Manufacturer part | Substitution Allowed |
|-----|-----------------------|------------------------|-----------|------------|--|------------------|-------------------------|----------------------|
| 1 | B1 | MDB10S | – | TSSOP–4 | Bridge Rectifier 1A, 1kV | ON Semiconductor | MDB10S | Yes |
| 1 | C1 | 220 nF | 20% | 0805 | Capacitor MLCC, SMD | Various | Various | Yes |
| 1 | C2 | 1 μ F / 25 V | 20% | 0805 | Capacitor MLCC, SMD | Various | Various | Yes |
| 1 | C3 | 2.2 nF | 20% | 0805 | Capacitor MLCC, SMD | Various | Various | Yes |
| 1 | C4 | 33 nF | 20% | 0805 | Capacitor MLCC, SMD | Various | Various | Yes |
| 1 | C5 | 100 μ F / 25 V | 20% | TH | Electrolytic Capacitor | Würth Elektronik | 860080473006 | Yes |
| 2 | C6, C7 | 10 μ F / 25 V, X7R | 20% | 1206 | Capacitor MLCC, SMD | Various | Various | Yes |
| 1 | C8 | 22 μ F / 16 V, X7R | 20% | 1206 | Capacitor MLCC, SMD | Murata | GRM31CZ71C226ME15L | Yes |
| 0 | C9 | NU | 20% | 0805 | Capacitor MLCC, SMD | Various | Various | Yes |
| 2 | CB1, CB2 | 10 μ F / 400 V | 20% | TH | Electrolytic Capacitor | Würth Elektronik | 860021375011 | Yes |
| 2 | CX1, CX2 | 220 nF / 275 Vac | – | TH | X Capacitor | Würth Elektronik | 890324023028 | Yes |
| 1 | D1 | BAV70L | – | SOT–23–3 | Switching Diode | ON Semiconductor | BAV70LT1G | Yes |
| 2 | D2, D3 | US1MFA | – | SOD–123 FL | Superfast Rectifier | ON Semiconductor | US1MFA | Yes |
| 0 | D4 | NU | – | SOD–123 | Zener Diode | ON Semiconductor | – | Yes |
| 1 | F1 | T1A | – | TH | Fuse | Bel Fuse | RST1 | Yes |
| 1 | IC1 | NCP10970B1 | – | SOIC–16 | Dual Output Controller | ON Semiconductor | NCP10970B1DR2G | No |
| 1 | L1 | 1 mH | – | TH SMD | Inductor 1 mH, 0.5A Inductor 1 mH, 0.4A | Würth Elektronik | 768772102 7687714102 | Yes |
| 1 | L2 | 2 x 10 mH | – | TH | Common Mode Choke | Würth Elektronik | 744821110 | Yes |
| 2 | LED_SW, LED_LDO | Red 3 mm | – | TH | Red LED 3mm | Various | Various | Yes |
| 3 | R1, R2, R8 | 150 k Ω | 1% | 1206 | Resistor, SMD | Various | Various | |
| 1 | R3 | 200 k Ω | 1% | 0805 | Resistor, SMD | Various | Various | Yes |
| 1 | R4 | 56 k Ω | 1% | 0805 | Resistor, SMD | Various | Various | Yes |
| 1 | R5 | 3.3 k Ω | 1% | 0603 | Resistor, SMD | Various | Various | Yes |
| 1 | R6 | 6.8 k Ω | 1% | 0603 | Resistor, SMD | Various | Various | Yes |
| 1 | R7 | 820 Ω | 1% | 0603 | Resistor, SMD | Various | Various | Yes |
| 0 | R9 | NU | 1% | 0805 | Resistor, SMD | Various | Various | Yes |
| 4 | RB1, RB2, RB3, RB4 | 3 M Ω | 1% | 1206 | Resistor, SMD | Various | Various | Yes |
| 0 | RV1 | NU | – | TH | Varistor | Würth Elektronik | 820474611 | Yes |

NOTES: All parts are Lead-free
TH = Through Hole

onsemi, **Onsemi**, and other names, marks, and brands are registered and/or common law trademarks of Semiconductor Components Industries, LLC dba "**onsemi**" or its affiliates and/or subsidiaries in the United States and/or other countries. **onsemi** owns the rights to a number of patents, trademarks, copyrights, trade secrets, and other intellectual property. A listing of **onsemi**'s product/patent coverage may be accessed at www.onsemi.com/site/pdf/Patent-Marking.pdf. **onsemi** is an Equal Opportunity/Affirmative Action Employer. This literature is subject to all applicable copyright laws and is not for resale in any manner.

The evaluation board/kit (research and development board/kit) (hereinafter the "board") is not a finished product and is not available for sale to consumers. The board is only intended for research, development, demonstration and evaluation purposes and will only be used in laboratory/development areas by persons with an engineering/technical training and familiar with the risks associated with handling electrical/mechanical components, systems and subsystems. This person assumes full responsibility/liability for proper and safe handling. Any other use, resale or redistribution for any other purpose is strictly prohibited.

THE BOARD IS PROVIDED BY ONSEMI TO YOU "AS IS" AND WITHOUT ANY REPRESENTATIONS OR WARRANTIES WHATSOEVER. WITHOUT LIMITING THE FOREGOING, ONSEMI (AND ITS LICENSORS/SUPPLIERS) HEREBY DISCLAIMS ANY AND ALL REPRESENTATIONS AND WARRANTIES IN RELATION TO THE BOARD, ANY MODIFICATIONS, OR THIS AGREEMENT, WHETHER EXPRESS, IMPLIED, STATUTORY OR OTHERWISE, INCLUDING WITHOUT LIMITATION ANY AND ALL REPRESENTATIONS AND WARRANTIES OF MERCHANTABILITY, FITNESS FOR A PARTICULAR PURPOSE, TITLE, NON-INFRINGEMENT, AND THOSE ARISING FROM A COURSE OF DEALING, TRADE USAGE, TRADE CUSTOM OR TRADE PRACTICE.

onsemi reserves the right to make changes without further notice to any board.

You are responsible for determining whether the board will be suitable for your intended use or application or will achieve your intended results. Prior to using or distributing any systems that have been evaluated, designed or tested using the board, you agree to test and validate your design to confirm the functionality for your application. Any technical, applications or design information or advice, quality characterization, reliability data or other services provided by **onsemi** shall not constitute any representation or warranty by **onsemi**, and no additional obligations or liabilities shall arise from **onsemi** having provided such information or services.

onsemi products including the boards are not designed, intended, or authorized for use in life support systems, or any FDA Class 3 medical devices or medical devices with a similar or equivalent classification in a foreign jurisdiction, or any devices intended for implantation in the human body. You agree to indemnify, defend and hold harmless **onsemi**, its directors, officers, employees, representatives, agents, subsidiaries, affiliates, distributors, and assigns, against any and all liabilities, losses, costs, damages, judgments, and expenses, arising out of any claim, demand, investigation, lawsuit, regulatory action or cause of action arising out of or associated with any unauthorized use, even if such claim alleges that **onsemi** was negligent regarding the design or manufacture of any products and/or the board.

This evaluation board/kit does not fall within the scope of the European Union directives regarding electromagnetic compatibility, restricted substances (RoHS), recycling (WEEE), FCC, CE or UL, and may not meet the technical requirements of these or other related directives.

FCC WARNING – This evaluation board/kit is intended for use for engineering development, demonstration, or evaluation purposes only and is not considered by **onsemi** to be a finished end product fit for general consumer use. It may generate, use, or radiate radio frequency energy and has not been tested for compliance with the limits of computing devices pursuant to part 15 of FCC rules, which are designed to provide reasonable protection against radio frequency interference. Operation of this equipment may cause interference with radio communications, in which case the user shall be responsible, at its expense, to take whatever measures may be required to correct this interference.

onsemi does not convey any license under its patent rights nor the rights of others.

LIMITATIONS OF LIABILITY: **onsemi** shall not be liable for any special, consequential, incidental, indirect or punitive damages, including, but not limited to the costs of requalification, delay, loss of profits or goodwill, arising out of or in connection with the board, even if **onsemi** is advised of the possibility of such damages. In no event shall **onsemi**'s aggregate liability from any obligation arising out of or in connection with the board, under any theory of liability, exceed the purchase price paid for the board, if any.

The board is provided to you subject to the license and other terms per **onsemi**'s standard terms and conditions of sale. For more information and documentation, please visit www.onsemi.com.

ADDITIONAL INFORMATION

TECHNICAL PUBLICATIONS:

Technical Library: www.onsemi.com/design/resources/technical-documentation
onsemi Website: www.onsemi.com

ONLINE SUPPORT: www.onsemi.com/support

For additional information, please contact your local Sales Representative at www.onsemi.com/support/sales