

TRF3761-x Integer-N PLL with Integrated VCO

1 Features

- Fully Integrated VCO
- Low Phase Noise: -137dBc/Hz (at 600kHz, f_{VCO} of 1.9GHz)
- Low Noise Floor: -158dBc/Hz at 10MHz Offset
- Integer-N PLL
- Input Reference Frequency range: 10MHz to 104MHz
- VCO Frequency Divided by 2-4 Output
- Output Buffer Enable Pin
- Programmable Charge Pump Current
- Hardware and Software Power Down
- 3-Wire Serial Interface
- Single Supply: 4.5V to 5.25V Operation

2 Applications

- Wireless Infrastructure
 - WCDMA, CDMA, GSM
 - Wideband Transceivers
 - Wireless Local Loop
 - RFID Transceivers
 - Clock generation
 - IF LO generation

3 Description

TRF3761 is a family of high performance, highly integrated frequency synthesizers, optimized for high performance applications. The TRF3761 includes a low-noise, voltage-controlled oscillator (VCO) and an integer-N PLL.

TRF3761 integrates divide-by 1, 2, or 4 options for a more flexible output frequency range. It is controlled through a 3-wire serial-programming-interface (SPI) interface. For power sensitive applications the TRF3761 can be powered down by the SPI interface or externally via chip_en pin 2.

Device Information⁽¹⁾

| PART NUMBER | PACKAGE | BODY SIZE (NOM) |
|-------------|-----------|-------------------|
| TRF3761 | VQFN (40) | 6.00 mm x 6.00 mm |
| TRF3761-x | | |

(1) For all available packages, see the orderable addendum at the end of the datasheet.

Application Schematic

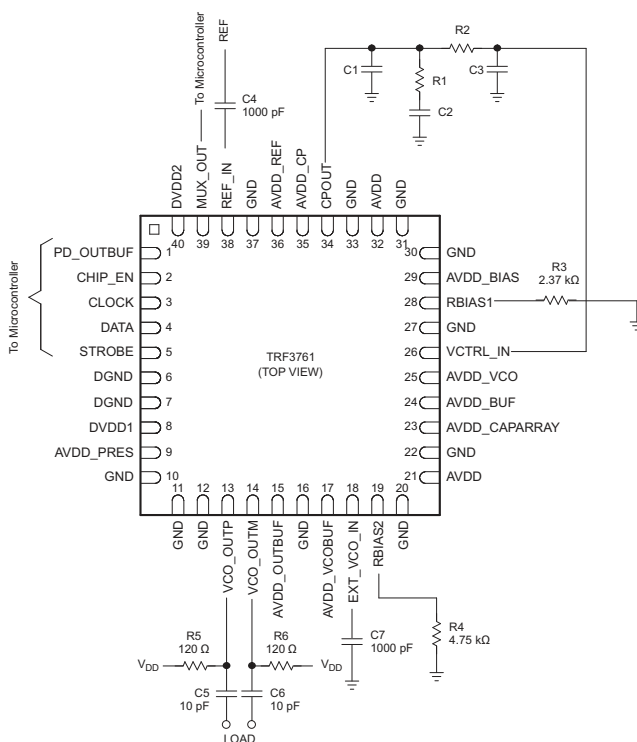

Table of Contents

| | | | |
|--|----------|--|-----------|
| 1 Features | 1 | 8 Detailed Description | 35 |
| 2 Applications | 1 | 8.1 Overview | 35 |
| 3 Description | 1 | 8.2 Functional Block Diagram | 35 |
| 4 Revision History | 2 | 8.3 Feature Description | 35 |
| 5 Device Comparison Table | 3 | 8.4 Device Functional Modes | 37 |
| 6 Pin Configuration and Functions | 3 | 8.5 Programming | 38 |
| 7 Specifications | 5 | 8.6 Register Maps | 39 |
| 7.1 Absolute Maximum Ratings | 5 | 9 Application and Implementation | 46 |
| 7.2 Recommended Operating Conditions | 5 | 9.1 Application Information | 46 |
| 7.3 Thermal Information | 5 | 9.2 Typical Applications | 48 |
| 7.4 Electrical Characteristics | 6 | 10 Power Supply Recommendations | 54 |
| 7.5 Electrical Characteristics, TRF3761-A | 7 | 11 Layout | 55 |
| 7.6 Electrical Characteristics, TRF3761-B | 8 | 11.1 Layout Guidelines | 55 |
| 7.7 Electrical Characteristics, TRF3761-C | 9 | 11.2 Layout Example | 55 |
| 7.8 Electrical Characteristics, TRF3761-D | 10 | 12 Device and Documentation Support | 56 |
| 7.9 Electrical Characteristics, TRF3761-E | 11 | 12.1 Related Links | 56 |
| 7.10 Electrical Characteristics, TRF3761-F | 12 | 12.2 Community Resources | 56 |
| 7.11 Electrical Characteristics, TRF3761-G | 13 | 12.3 Trademarks | 56 |
| 7.12 Electrical Characteristics, TRF3761-H | 14 | 12.4 Electrostatic Discharge Caution | 56 |
| 7.13 Electrical Characteristics, TRF3761-J | 15 | 12.5 Glossary | 56 |
| 7.14 Timing Requirements | 16 | 13 Mechanical, Packaging, and Orderable Information | 56 |
| 7.15 Typical Characteristics | 17 | | |

4 Revision History

NOTE: Page numbers for previous revisions may differ from page numbers in the current version.

| Changes from Revision J (August 2009) to Revision K | Page |
|---|------|
| • Added <i>Pin Configuration and Functions</i> section, <i>ESD Rating</i> table, <i>Feature Description</i> section, <i>Device Functional Modes</i> , <i>Application and Implementation</i> section, <i>Power Supply Recommendations</i> section, <i>Layout</i> section, <i>Device and Documentation Support</i> section, and <i>Mechanical, Packaging, and Orderable Information</i> section | 1 |
| • Changed High-level input voltage MIN value From: 2.5 To: $V_{CC} - 2V$ | 6 |

| Changes from Revision I (March 2008) to Revision J | Page |
|--|------|
| • Changed Figure 2 | 17 |
| • Changed Figure 3 | 17 |
| • Changed Figure 4 | 17 |
| • Changed Figure 5 | 17 |
| • Changed Figure 6 | 17 |
| • Changed Figure 7 | 17 |
| • Changed Figure 8 | 18 |
| • Changed Figure 9 | 18 |
| • Changed Figure 10 | 18 |

5 Device Comparison Table

| PART NUMBER | Div by 1 | | Div by 2 | | Div by 4 | |
|-------------|----------|-------|----------|--------|----------|--------|
| | Fstart | Fstop | Fstart | Fstop | Fstart | Fstop |
| TRF3761-A | 1493 | 1608 | 746.5 | 804 | 373.25 | 402 |
| TRF3761-B | 1595 | 1711 | 797.5 | 855.5 | 398.75 | 427.75 |
| TRF3761-C | 1660 | 1790 | 830 | 895 | 415 | 447.5 |
| TRF3761-D | 1740 | 1866 | 870 | 933 | 435 | 466.5 |
| TRF3761-E | 1805 | 1936 | 902.5 | 968 | 451.25 | 484 |
| TRF3761-F | 1850 | 1984 | 925 | 992 | 462.5 | 496 |
| TRF3761-G | 1920 | 2059 | 960 | 1029.5 | 480 | 514.75 |
| TRF3761-H | 2028 | 2175 | 1014 | 1087.5 | 507 | 543.75 |
| TRF3761-J | 2140 | 2295 | 1070 | 1147.5 | 535 | 573.75 |

6 Pin Configuration and Functions

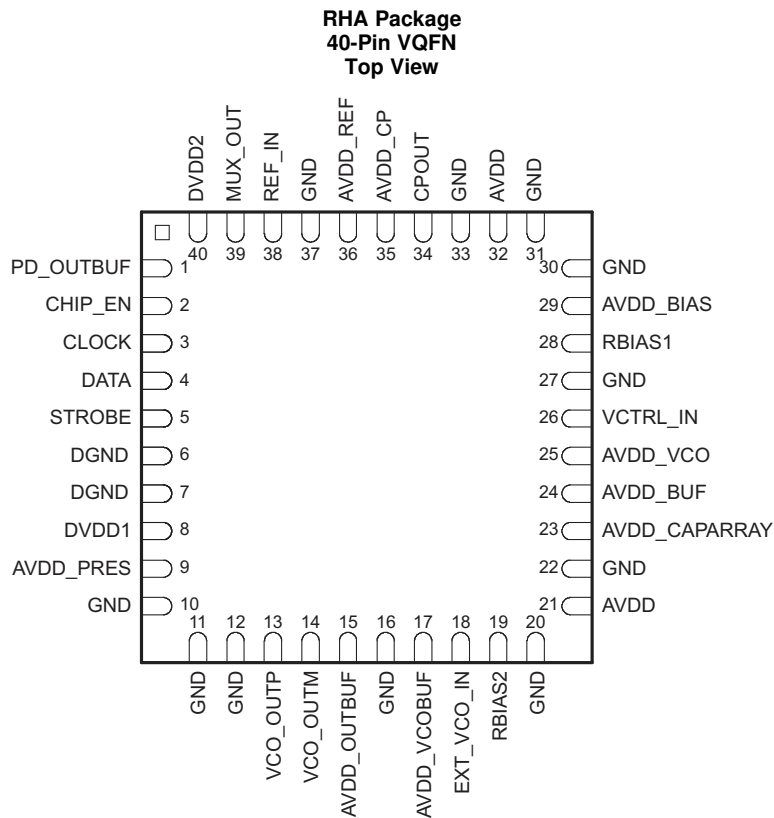

Pin Functions

| PIN ⁽¹⁾ | | I/O | DESCRIPTION |
|--------------------|---|-----|---|
| NAME | NO. | | |
| PD_OUTBUF | 1 | I | Once configured in register 1, this pin will control the output buffer. Logic level 0 turns on the buffer and logic level 1 turns off the buffer. |
| CHIP_EN | 2 | I | This pin requires 4.5 to 5.25 V applied for normal operation. Grounding this pin will disable the chip. |
| CLOCK | 3 | I | Serial-programming-interface clock |
| DATA | 4 | I/O | Serial-programming-interface data, used for programming the frequency and other features. |
| STROBE | 5 | I | Serial-programming-interface strobe required to write the data to the chip |
| DGND | 6, 7 | | Digital ground |
| DVDD1 | 8 | | Digital power supply, requires 4.5 to 5.25 V, Suggested decoupling, 0.1µF and 10pF capacitors in parallel. |
| AVDD_PRES | 9 | | Power supply for prescaler circuit, requires 4.5 to 5.25 V, Suggested decoupling, 0.1µF and 10pF capacitors in parallel. |
| VCO_OUTP | 13 | O | VCO output, can be used single ended matched to 50 ohms or in conjunction with VCO_OUTM (pin 14) with a balun. |
| VCO_OUTM | 14 | O | VCO output, can be used single ended matched to 50 ohms or in conjunction with VCO_OUTP (pin 13) with a balun. |
| AVDD_OUTBUF | 15 | | Power supply for output buffers, requires 4.5 to 5.25 V, Suggested decoupling, 0.1µF and 10pF capacitors in parallel. |
| AVDD_VCOBUF | 17 | | Power supply for VCO buffers, requires 4.5 to 5.25 V, Suggested decoupling, 0.1µF and 10pF capacitors in parallel. |
| EXT_VCO_IN | 18 | I | External VCO input to prescaler, If using an external VCO instead of the internal VCO. |
| RBIAS2 | 19 | I/O | External bias resistor for setting the internal reference current requires a 4.75K ohm resistor to ground. |
| AVDD | 21 | | Analog power supply, requires 4.5 to 5.25 V, Suggested decoupling, 0.1µF and 10pF capacitors in parallel. |
| AVDD_CAPARRAY | 23 | | Power supply for VCO core and buffer, requires 4.5 to 5.25 V, Suggested decoupling, 0.1µF and 10pF capacitors in parallel. |
| AVDD_BUF | 24 | | Power supply for VCO core and buffer, requires 4.5 to 5.25 V, Suggested decoupling, 0.1µF and 10pF capacitors in parallel. |
| AVDD_VCO | 25 | | Power supply for VCO core and buffer, requires 4.5 to 5.25 V, Suggested decoupling, 0.1µF and 10pF capacitors in parallel. |
| VCTRL_IN | 26 | I | VCO control voltage, the output of the loop filter is applied to this pin. |
| RBIAS1 | 28 | I/O | External bias resistor for setting charge pump reference current, requires 2.37K ohm resistor to ground. |
| AVDD_BIAS | 29 | | Power supply for band gap current bias, requires 4.5 to 5.25 V, Suggested decoupling, 0.1µF and 10pF capacitors in parallel. |
| GND | 10, 11, 12, 16, 20, 22, 27, 30, 31, 33, 37 | | Analog ground |
| AVDD | 32 | | Power supply for FUSE cell, requires 4.5 to 5.25 V. Suggested decoupling, 0.1µF, 1nF and 1pF capacitors in parallel. |
| CPOUT | 34 | O | Charge pump output, connected to the input of loop filter. |
| AVDD_CP | 35 | | Analog power supply for charge pump, requires 4.5 to 5.25 V, Suggested decoupling, 0.1µF and 10pF capacitors in parallel |
| AVDD_REF | 36 | | Power supply for REF_IN circuitry, requires 4.5 to 5.25 V, Suggested decoupling, 0.1µF and 10pF capacitors in parallel. |
| REF_IN | 38 | I | Reference signal input, reference oscillator input of 10MHz to 104MHz. |
| MUX_OUT | 39 | O | Generally used for digital lock detect, can be used to verify locked condition by microcontroller, high = locked, low = unlocked. |
| DVDD2 | 40 | | Power supply for the digital regulator, requires 4.5 to 5.25 V, Suggested decoupling, 0.1µF and 10pF capacitors in parallel. |

(1) Power Supply = V_{CC} = (DVDD1, AVDD1, AVDD_PRES, AVDD_VCOBUF, AVDD, AVDD_CAPARRAY, AVDD_BUF, AVDD_VCO, AVDD_BIAS, AVDD_CP, AVDD_REF, DVDD2)

7 Specifications

7.1 Absolute Maximum Ratings

over operating free-air temperature range (unless otherwise noted)⁽¹⁾

| | MIN | MAX | UNIT |
|---|------|----------------------|------|
| Supply voltage range ⁽²⁾ | -0.3 | 5.5 | V |
| Digital I/O voltage range | -0.3 | V _{CC} +0.3 | V |
| T _J Operating virtual junction temperature range | -40 | 150 | °C |
| T _{stg} Storage temperature | -65 | 150 | °C |

(1) Stresses beyond those listed under Absolute Maximum Ratings may cause permanent damage to the device. These are stress ratings only, and functional operation of the device at these or any other conditions beyond those indicated under *Recommended Operating Conditions* is not implied. Exposure to absolute maximum rated conditions for extended periods may affect device reliability.

(2) All voltage values are with respect to network ground terminal.

7.2 Recommended Operating Conditions

over operating free-air temperature range (unless otherwise noted)

| | MIN | NOM | MAX | UNIT |
|---|-----|-----|------|------------------|
| V _{CC} Power supply voltage | 4.5 | 5 | 5.25 | V |
| Power supply voltage ripple | | | 940 | μV _{pp} |
| T _A Operating free air temperature range | -40 | | 85 | °C |
| T _J Operating virtual junction temperature range | -40 | | 150 | °C |

7.3 Thermal Information

| THERMAL METRIC ⁽¹⁾ | | TRF3761 | UNIT |
|--|--------------------------------|------------|------|
| | | RHA (VQFN) | |
| | | 40 PINS | |
| R _{θJA} Junction-to-ambient thermal resistance | Soldered slug, no airflow | 26 | °C/W |
| | Soldered slug, 200-LFM airflow | 20.1 | °C/W |
| | Soldered slug, 400-LFM airflow | 17.4 | °C/W |
| R _{θJC(top)} Junction-to-case (top) thermal resistance | | 16.4 | °C/W |
| R _{θJB} Junction-to-board thermal resistance | | 4.7 | °C/W |
| ψ _{JT} Junction-to-top characterization parameter | | 0.2 | °C/W |
| ψ _{JB} Junction-to-board characterization parameter | | 4.6 | °C/W |
| R _{θJC(bot)} Junction-to-case (bottom) thermal resistance | | 1 | °C/W |

(1) For more information about traditional and new thermal metrics, see the *Semiconductor and IC Package Thermal Metrics* application report, [SPRA953](#).

7.4 Electrical Characteristics

Supply voltage = $V_{CC} = 4.5\text{ V to }5.25\text{ V}$, $T_A = -40\text{ to }85^\circ\text{C}$ (unless otherwise noted)

| PARAMETER | | TEST CONDITIONS | MIN | TYP | MAX | UNIT |
|--|---------------------------------------|--------------------------|--------------------|-----|-------------|----------|
| DC PARAMETERS | | | | | | |
| I_{CC} | Total supply current | $T_A = 25^\circ\text{C}$ | Divide by 1 output | | 130 | mA |
| | | | Divide by 2 output | | 140 | mA |
| | | | Divide by 4 output | | 150 | mA |
| REFERENCE OSCILLATOR PARAMETERS | | | | | | |
| f_{ref} | Reference frequency | | 10 | | 104 | MHz |
| | Reference input sensitivity (REF_IN) | | 0.2 | | 2.5 | V_{PP} |
| | Reference input impedance (REF_IN) | Parallel capacitance | | 5 | 6.52 | pF |
| | | Parallel resistance | 3913 | | | Ω |
| PFD CHARGE PUMP | | | | | | |
| | PFD frequency | | | | 30 | MHz |
| | Charge pump current (I_{CP_OUT}) | SPI programmable | | 5.6 | | mA |
| DIGITAL INTERFACE (PD_OUTBUF, CHIP_EN, CLOCK, DATA, STROBE) | | | | | | |
| V_{IH} | High-level input voltage | | $V_{CC} - 2$ | | V_{CC} | V |
| V_{IL} | Low-level input voltage | | 0 | | 0.8 | V |
| V_{OH} | High-level output voltage | | $0.8V_{CC}$ | | | V |
| V_{OL} | Low-level output voltage | | | | $0.2V_{CC}$ | V |
| OUTPUT POWER | | | | | | |
| | Single ended | | | 0 | | dBm |
| | Differential | | | 3 | | dBm |

7.5 Electrical Characteristics, TRF3761-A

 Supply voltage = $V_{CC} = 5\text{ V}$, $T_A = -40\text{ to }85^\circ\text{C}$ (unless otherwise noted)

| PARAMETER | TEST CONDITIONS | MIN | TYP | MAX | UNIT |
|---|---|---------------|---------|-----|--------|
| NOISE CHARACTERISTICS | | | | | |
| VCO phase noise, Free running VCO direct output | $f_{VCO} = 1554\text{MHz}$, $f_O = 1554\text{MHz}$ | 100kHz offset | -116.7 | | dBc/Hz |
| | | 600kHz offset | -136 | | |
| | | 1MHz offset | -141.6 | | |
| | | 6MHz offset | -156.1 | | |
| | | 10MHz offset | -158.1 | | |
| VCO phase noise, Free running VCO divide-by-2 output | $f_{VCO} = 1554\text{MHz}$, $f_O = 777\text{MHz}$ | 100kHz offset | -122.8 | | dBc/Hz |
| | | 600kHz offset | -142.7 | | |
| | | 1MHz offset | -147.5 | | |
| | | 6MHz offset | -157 | | |
| | | 10MHz offset | -158.1 | | |
| VCO phase noise, Free running VCO divide-by-4 output | $f_{VCO} = 1554\text{MHz}$, $f_O = 388.5\text{MHz}$ | 100kHz offset | -127.7 | | dBc/Hz |
| | | 600kHz offset | -148.4 | | |
| | | 1MHz offset | -151.8 | | |
| | | 6MHz offset | -156.3 | | |
| | | 10MHz offset | -155.9 | | |
| VCO phase noise, Closed loop phase noise direct output ^{(1) (2) (3)} | $f_{VCO} = 1554\text{MHz}$, $f_O = 1554\text{MHz}$ | 1kHz offset | -83.4 | | dBc/Hz |
| | | 600kHz offset | -135 | | |
| | | 1MHz offset | -140.2 | | |
| | | 10MHz offset | -158.2 | | |
| RMS phase error Closed loop phase noise direct output ⁽³⁾ | 100Hz to 10MHz | | 0.95° | | |
| VCO phase noise, Closed loop phase noise divide-by-2 output ^{(1) (2) (3)} | $f_{VCO} = 1554\text{MHz}$, $f_O = 777\text{MHz}$ | 1kHz offset | -90.4 | | dBc/Hz |
| | | 600kHz offset | -141 | | |
| | | 1MHz offset | -146.2 | | |
| | | 10MHz offset | -158.25 | | |
| RMS phase error Closed loop phase noise divide-by-2 output ⁽³⁾ | 100Hz to 10MHz | | 0.63° | | |
| VCO phase noise, Closed loop phase noise divide-by-4 output ^{(1) (2) (3)} | $f_{VCO} = 1554\text{MHz}$, $f_O = 388.5\text{MHz}$ | 1kHz offset | -95 | | dBc/Hz |
| | | 600kHz offset | -147 | | |
| | | 1MHz offset | -151 | | |
| | | 10MHz offset | -156 | | |
| RMS phase error Closed loop phase noise divide-by-4 output ⁽³⁾ | 100Hz to 10MHz | | 0.39° | | |
| VCO gain, Kv | VCO free running | | 23 | | MHz/V |
| Reference spur ⁽²⁾ | | | -80 | | dBc |

 (1) See Application Circuit [Figure 87](#).

(2) PFD = 200kHz, Loop Filter BW = 15kHz, Output frequency step = 200kHz.

(3) Reference oscillator RMS phase error = 0.008250°, RMS jitter = 881.764 fs.

7.6 Electrical Characteristics, TRF3761-B

Supply voltage = $V_{CC} = 5\text{ V}$, $T_A = -40\text{ to }85^\circ\text{C}$ (unless otherwise noted)

| PARAMETER | TEST CONDITIONS | MIN | TYP | MAX | UNIT |
|---|---|---------------|---------|-----|--------|
| NOISE CHARACTERISTICS | | | | | |
| VCO phase noise, Free running VCO direct output | $f_{VCO} = 1651\text{MHz}$, $f_O = 1651\text{MHz}$ | 100kHz offset | -119.34 | | dBc/Hz |
| | | 600kHz offset | -139 | | |
| | | 1MHz offset | -142.1 | | |
| | | 6MHz offset | -156.6 | | |
| | | 10MHz offset | -158.6 | | |
| VCO phase noise, Free running VCO divide-by-2 output | $f_{VCO} = 1651\text{MHz}$, $f_O = 825.5\text{ MHz}$ | 100kHz offset | -127.8 | | dBc/Hz |
| | | 600kHz offset | -146.5 | | |
| | | 1MHz offset | -149 | | |
| | | 6MHz offset | -156.2 | | |
| | | 10MHz offset | -158.4 | | |
| VCO phase noise, Free running VCO divide-by-4 output | $f_{VCO} = 1651\text{MHz}$, $f_O = 412.75\text{ MHz}$ | 100kHz offset | -127.3 | | dBc/Hz |
| | | 600kHz offset | -151.4 | | |
| | | 1MHz offset | -153 | | |
| | | 6MHz offset | -155.5 | | |
| | | 10MHz offset | -155.9 | | |
| VCO phase noise, Closed loop phase noise direct output ^{(1) (2) (3)} | $f_{VCO} = 1651\text{MHz}$, $f_O = 1651\text{MHz}$ | 1kHz offset | -83.5 | | dBc/Hz |
| | | 600kHz offset | -138 | | |
| | | 1MHz offset | -141.8 | | |
| | | 10MHz offset | -158.2 | | |
| RMS phase error Closed loop phase noise direct output ⁽³⁾ | 100Hz to 10MHz | | 0.85° | | |
| VCO phase noise, Closed loop phase noise divide-by-2 output ^{(1) (2) (3)} | $f_{VCO} = 1651\text{MHz}$, $f_O = 825.5\text{ MHz}$ | 1kHz offset | -90.2 | | dBc/Hz |
| | | 600kHz offset | -146 | | |
| | | 1MHz offset | -147.39 | | |
| | | 10MHz offset | -158.25 | | |
| RMS phase error Closed loop phase noise divide-by-2 output ⁽³⁾ | 100Hz to 10MHz | | 0.53° | | |
| VCO phase noise, Closed loop phase noise divide-by-4 output ^{(1) (2) (3)} | $f_{VCO} = 1651\text{MHz}$, $f_O = 412.75\text{ MHz}$ | 1kHz offset | -95.7 | | dBc/Hz |
| | | 600kHz offset | -151 | | |
| | | 1MHz offset | -154 | | |
| | | 10MHz offset | -156 | | |
| RMS phase error Closed loop phase noise divide-by-4 output ⁽³⁾ | 100Hz to 10MHz | | 0.33° | | |
| VCO gain, Kv | VCO free running | | 23 | | MHz/V |
| Reference spur ⁽²⁾ | | | -80 | | dBc |

(1) See Application Circuit [Figure 87](#).

(2) PFD = 200kHz, Loop Filter BW = 15kHz, Output frequency step = 200kHz.

(3) Reference oscillator RMS phase error = 0.008250°, RMS jitter = 881.764 fs.

7.7 Electrical Characteristics, TRF3761-C

Supply voltage = $V_{CC} = 5\text{ V}$, $T_A = -40\text{ to }85^\circ\text{C}$ (unless otherwise noted)

| PARAMETER | TEST CONDITIONS | MIN | TYP | MAX | UNIT |
|---|---|---------------|---------|-----|--------|
| NOISE CHARACTERISTICS | | | | | |
| VCO phase noise, Free running VCO direct output | $f_{VCO} = 1723\text{MHz}$, $f_O = 1700\text{MHz}$ | 100kHz offset | -119.5 | | dBc/Hz |
| | | 600kHz offset | -138.8 | | |
| | | 1MHz offset | -143.9 | | |
| | | 6MHz offset | -155.3 | | |
| | | 10MHz offset | -157.5 | | |
| VCO phase noise, Free running VCO divide-by-2 output | $f_{VCO} = 1723\text{MHz}$, $f_O = 861.5\text{ MHz}$ | 100kHz offset | -126 | | dBc/Hz |
| | | 600kHz offset | -145.2 | | |
| | | 1MHz offset | -149.5 | | |
| | | 6MHz offset | -157.2 | | |
| | | 10MHz offset | -158 | | |
| VCO phase noise, Free running VCO divide-by-4 output | $f_{VCO} = 1723\text{MHz}$, $f_O = 430.75\text{ MHz}$ | 100kHz offset | -133 | | dBc/Hz |
| | | 600kHz offset | -151 | | |
| | | 1MHz offset | -153.8 | | |
| | | 6MHz offset | -156 | | |
| | | 10MHz offset | -156.5 | | |
| VCO phase noise, Closed loop phase noise direct output ^{(1) (2) (3)} | $f_{VCO} = 1723\text{MHz}$, $f_O = 1723\text{MHz}$, | 1kHz offset | -85 | | dBc/Hz |
| | | 600kHz offset | -138.34 | | |
| | | 1MHz offset | -142.68 | | |
| | | 10MHz offset | -157.3 | | |
| RMS phase error Closed loop phase noise direct output ⁽³⁾ | 100Hz to 10MHz | | 0.87° | | |
| VCO phase noise, Closed loop phase noise divide-by-2 output ^{(1) (2) (3)} | $f_{VCO} = 1723\text{MHz}$, $f_O = 861.5\text{ MHz}$ | 1kHz offset | -90.1 | | dBc/Hz |
| | | 600kHz offset | -145 | | |
| | | 1MHz offset | -148.6 | | |
| | | 10MHz offset | -158 | | |
| RMS phase error Closed loop phase noise divide-by-2 output ⁽³⁾ | 100Hz to 10MHz | | 0.53° | | |
| VCO phase noise, Closed loop phase noise divide-by-4 output ^{(1) (2) (3)} | $f_{VCO} = 1723\text{MHz}$, $f_O = 430.75\text{ MHz}$ | 1kHz offset | -96.2 | | dBc/Hz |
| | | 600kHz offset | -151 | | |
| | | 1MHz offset | -153 | | |
| | | 10MHz offset | -156 | | |
| RMS phase error Closed loop phase noise divide-by-4 output ⁽³⁾ | 100Hz to 10MHz | | 0.33° | | |
| VCO gain, Kv | VCO free running | | 23 | | MHz/V |
| Reference spur ⁽²⁾ | | | -80 | | dBc |

(1) See Application Circuit [Figure 87](#).

(2) PFD = 200kHz, Loop Filter BW = 15kHz, Output frequency step = 200kHz.

(3) Reference oscillator RMS phase error = 0.008250°, RMS jitter = 881.764 fs.

7.8 Electrical Characteristics, TRF3761-D

Supply voltage = $V_{CC} = 5\text{ V}$, $T_A = -40\text{ to }85^\circ\text{C}$ (unless otherwise noted)

| PARAMETER | TEST CONDITIONS | MIN | TYP | MAX | UNIT |
|---|--|---------------|-------|--------|--------|
| NOISE CHARACTERISTICS | | | | | |
| VCO phase noise, Free running VCO direct output | $f_{VCO} = 1817\text{MHz}$, $f_O = 1817\text{MHz}$ | 100kHz offset | | -118 | dBc/Hz |
| | | 600kHz offset | | -138.5 | |
| | | 1MHz offset | | -144 | |
| | | 6MHz offset | | -156 | |
| | | 10MHz offset | | -158 | |
| VCO phase noise, Free running VCO divide-by-2 output | $f_{VCO} = 1817\text{MHz}$, $f_O = 908.5\text{MHz}$ | 100kHz offset | | -124.8 | dBc/Hz |
| | | 600kHz offset | | -145.2 | |
| | | 1MHz offset | | -148 | |
| | | 6MHz offset | | -157.8 | |
| | | 10MHz offset | | -158.2 | |
| VCO phase noise, Free running VCO divide-by-4 output | $f_{VCO} = 1817\text{MHz}$, $f_O = 454.25\text{MHz}$ | 100kHz offset | | -132 | dBc/Hz |
| | | 600kHz offset | | -151 | |
| | | 1MHz offset | | -154 | |
| | | 6MHz offset | | -157 | |
| | | 10MHz offset | | -157.5 | |
| VCO phase noise, Closed loop phase noise direct output ^{(1) (2) (1)} | $f_{VCO} = 1817\text{MHz}$, $f_O = 1817\text{MHz}$ | 1kHz offset | | -85 | dBc/Hz |
| | | 600kHz offset | | -139 | |
| | | 1MHz offset | | -144 | |
| | | 10MHz offset | | -159 | |
| RMS phase error Closed loop phase noise direct output ⁽³⁾ | 100Hz to 10MHz | | 0.85° | | |
| VCO phase noise, Closed loop phase noise divide-by-2 output ^{(1) (2) (3)} | $f_{VCO} = 1817\text{MHz}$, $f_O = 908.5\text{MHz}$ | 1kHz offset | | -91 | dBc/Hz |
| | | 600kHz offset | | -146 | |
| | | 1MHz offset | | -149 | |
| | | 10MHz offset | | -159 | |
| RMS phase error Closed loop phase noise divide-by-2 output ⁽³⁾ | 100Hz to 10MHz | | 0.47° | | |
| VCO phase noise, Closed loop phase noise divide-by-4 output ^{(1) (2) (3)} | $f_{VCO} = 1817\text{MHz}$, $f_O = 454.25\text{MHz}$ | 1kHz offset | | -97 | dBc/Hz |
| | | 600kHz offset | | -151 | |
| | | 1MHz offset | | -154 | |
| | | 10MHz offset | | -157 | |
| RMS phase error Closed loop phase noise divide-by-4 output ⁽³⁾ | 100Hz to 10MHz | | 0.34° | | |
| VCO gain, Kv | VCO free running | | 23 | | MHz/V |
| Reference spur ⁽²⁾ | | | -80 | | dBc |

(1) See Application Circuit [Figure 87](#).

(2) PFD = 200kHz, Loop Filter BW = 15kHz, Output frequency step = 200kHz.

(3) Reference oscillator RMS phase error = 0.008250°, RMS jitter = 881.764 fs.

7.9 Electrical Characteristics, TRF3761-E

 Supply voltage = $V_{CC} = 5\text{ V}$, $T_A = -40\text{ to }85^\circ\text{C}$ (unless otherwise noted)

| PARAMETER | TEST CONDITIONS | MIN | TYP | MAX | UNIT |
|---|--|---------------|-------|--------|--------|
| NOISE CHARACTERISTICS | | | | | |
| VCO phase noise, Free running VCO direct output | $f_{VCO} = 1869\text{MHz}$, $f_O = 1869\text{MHz}$ | 100kHz offset | | -118 | dBc/Hz |
| | | 600kHz offset | | -138 | |
| | | 1MHz offset | | -142 | |
| | | 6MHz offset | | -155 | |
| | | 10MHz offset | | -157.3 | |
| VCO phase noise, Free running VCO divide-by-2 output | $f_{VCO} = 1869\text{MHz}$, $f_O = 934.5\text{MHz}$ | 100kHz offset | | -126 | dBc/Hz |
| | | 600kHz offset | | -144 | |
| | | 1MHz offset | | -149 | |
| | | 6MHz offset | | -158 | |
| | | 10MHz offset | | -158.2 | |
| VCO phase noise, Free running VCO divide-by-4 output | $f_{VCO} = 1869\text{MHz}$, $f_O = 467.25\text{MHz}$ | 100kHz offset | | -132 | dBc/Hz |
| | | 600kHz offset | | -150 | |
| | | 1MHz offset | | -154 | |
| | | 6MHz offset | | -157 | |
| | | 10MHz offset | | -157.3 | |
| VCO phase noise, Closed loop phase noise direct output ^{(1) (2) (3)} | $f_{VCO} = 1869\text{MHz}$, $f_O = 1869\text{MHz}$ | 1kHz offset | | -84.5 | dBc/Hz |
| | | 600kHz offset | | -140 | |
| | | 1MHz offset | | -143.6 | |
| | | 10MHz offset | | -157 | |
| RMS phase error Closed loop phase noise direct output ⁽³⁾ | 100Hz to 10MHz | | 0.9° | | |
| VCO phase noise, Closed loop phase noise divide-by-2 output ^{(1) (2) (3)} | $f_{VCO} = 1869\text{MHz}$, $f_O = 934.5\text{MHz}$ | 1kHz offset | | -90.7 | dBc/Hz |
| | | 600kHz offset | | -144 | |
| | | 1MHz offset | | -148.5 | |
| | | 10MHz offset | | -158 | |
| RMS phase error Closed loop phase noise divide-by-2 output ⁽³⁾ | 100Hz to 10MHz | | 0.53° | | |
| VCO phase noise, Closed loop phase noise divide-by-4 output ^{(1) (2) (3)} | $f_{VCO} = 1869\text{MHz}$, $f_O = 467.25\text{MHz}$ | 1kHz offset | | -95 | dBc/Hz |
| | | 600kHz offset | | -150 | |
| | | 1MHz offset | | -154 | |
| | | 10MHz offset | | -157 | |
| RMS phase error Closed loop phase noise divide-by-4 output ⁽³⁾ | 100Hz to 10MHz | | 0.35° | | |
| VCO gain, Kv | VCO free running | | 23 | | MHz/V |
| Reference spur ⁽²⁾ | | | -80 | | dBc |

 (1) See Application Circuit [Figure 87](#).

(2) PFD = 200kHz, Loop Filter BW = 15kHz, Output frequency step = 200kHz.

(3) Reference oscillator RMS phase error = 0.008250°, RMS jitter = 881.764 fs.

7.10 Electrical Characteristics, TRF3761-F

Supply voltage = $V_{CC} = 5\text{ V}$, $T_A = -40\text{ to }85^\circ\text{C}$ (unless otherwise noted)

| PARAMETER | TEST CONDITIONS | MIN | TYP | MAX | UNIT |
|---|--|---------------|--------|--------|--------|
| NOISE CHARACTERISTICS | | | | | |
| VCO phase noise, Free running VCO direct output | $f_{VCO} = 1916\text{MHz}$, $f_O = 1916\text{MHz}$ | 100kHz offset | | -116 | dBc/Hz |
| | | 600kHz offset | | -137 | |
| | | 1MHz offset | | -141 | |
| | | 6MHz offset | | -155 | |
| | | 10MHz offset | | -157 | |
| VCO phase noise, Free running VCO divide-by-2 output | $f_{VCO} = 1916\text{MHz}$, $f_O = 958\text{MHz}$ | 100kHz offset | | -113 | dBc/Hz |
| | | 600kHz offset | | -136 | |
| | | 1MHz offset | | -147.5 | |
| | | 6MHz offset | | -155 | |
| | | 10MHz offset | | -157.5 | |
| VCO phase noise, Free running VCO divide-by-4 output | $f_{VCO} = 1916\text{MHz}$, $f_O = 479\text{MHz}$ | 100kHz offset | | -128 | dBc/Hz |
| | | 600kHz offset | | -148 | |
| | | 1MHz offset | | -150 | |
| | | 6MHz offset | | -155 | |
| | | 10MHz offset | | -156 | |
| VCO phase noise, Closed loop phase noise direct output ^{(1) (2) (3)} | $f_{VCO} = 1916\text{MHz}$, $f_O = 1916\text{MHz}$ | 1kHz offset | | -82.5 | dBc/Hz |
| | | 600kHz offset | | -136.7 | |
| | | 1MHz offset | | -142 | |
| | | 10MHz offset | | -157 | |
| RMS phase error Closed loop phase noise direct output ⁽³⁾ | 100Hz to 10MHz | | 0.947° | | |
| VCO phase noise, Closed loop phase noise divide-by-2 output ^{(1) (2) (3)} | $f_{VCO} = 1916\text{MHz}$, $f_O = 958\text{MHz}$ | 1kHz offset | | -88.6 | dBc/Hz |
| | | 600kHz offset | | -142.6 | |
| | | 1MHz offset | | -148.2 | |
| | | 10MHz offset | | -158 | |
| RMS phase error Closed loop phase noise divide-by-2 output ⁽³⁾ | 100Hz to 10MHz | | 0.477° | | |
| VCO phase noise, Closed loop phase noise divide-by-4 output ^{(1) (2) (3)} | $f_{VCO} = 1916\text{MHz}$, $f_O = 479\text{MHz}$ | 1kHz offset | | -95 | dBc/Hz |
| | | 600kHz offset | | -148 | |
| | | 1MHz offset | | -152 | |
| | | 10MHz offset | | -156 | |
| RMS phase error Closed loop phase noise divide-by-4 output ⁽³⁾ | 100Hz to 10MHz | | 0.231° | | |
| VCO gain, Kv | VCO free running | | 23 | | MHz/V |
| Reference spur ⁽²⁾ | | | -80 | | dBc |

(1) See Application Circuit [Figure 87](#).

(2) PFD = 200kHz, Loop Filter BW = 15kHz, Output frequency step = 200kHz.

(3) Reference oscillator RMS phase error = 0.008250°, RMS jitter = 881.764 fs.

7.11 Electrical Characteristics, TRF3761-G

 Supply voltage = $V_{CC} = 5\text{ V}$, $T_A = -40\text{ to }85^\circ\text{C}$ (unless otherwise noted)

| PARAMETER | TEST CONDITIONS | MIN | TYP | MAX | UNIT |
|---|--|---------------|--------|--------|--------|
| NOISE CHARACTERISTICS | | | | | |
| VCO phase noise, Free running VCO direct output | $f_{VCO} = 1989\text{MHz}$, $f_O = 1989\text{MHz}$ | 100kHz offset | | -115 | dBc/Hz |
| | | 600kHz offset | | -136 | |
| | | 1MHz offset | | -141.2 | |
| | | 6MHz offset | | -155.6 | |
| | | 10MHz offset | | -159 | |
| VCO phase noise, Free running VCO divide-by-2 output | $f_{VCO} = 1989\text{MHz}$, $f_O = 994.5\text{MHz}$ | 100kHz offset | | -121.3 | dBc/Hz |
| | | 600kHz offset | | -142.4 | |
| | | 1MHz offset | | -141.5 | |
| | | 6MHz offset | | -157.2 | |
| | | 10MHz offset | | -158 | |
| VCO phase noise, Free running VCO divide-by-4 output | $f_{VCO} = 1989\text{MHz}$, $f_O = 497.25\text{MHz}$ | 100kHz offset | | -128 | dBc/Hz |
| | | 600kHz offset | | -148 | |
| | | 1MHz offset | | -151 | |
| | | 6MHz offset | | -156.8 | |
| | | 10MHz offset | | -157 | |
| VCO phase noise, Closed loop phase noise direct output ^{(1) (2) (3)} | $f_{VCO} = 1989\text{MHz}$, $f_O = 1989\text{MHz}$ | 1kHz offset | | -83 | dBc/Hz |
| | | 600kHz offset | | -136 | |
| | | 1MHz offset | | -141 | |
| | | 10MHz offset | | -159 | |
| RMS phase error Closed loop phase noise direct output ⁽³⁾ | 100Hz to 10MHz | | 1° | | |
| VCO phase noise, Closed loop phase noise divide-by-2 output ^{(1) (2) (3)} | $f_{VCO} = 1989\text{MHz}$, $f_O = 994.5\text{MHz}$ | 1kHz offset | | -88.7 | dBc/Hz |
| | | 600kHz offset | | -141.9 | |
| | | 1MHz offset | | -147.5 | |
| | | 10MHz offset | | -158 | |
| RMS phase error Closed loop phase noise divide-by-2 output ⁽³⁾ | 100Hz to 10MHz | | 0.509° | | |
| VCO phase noise, Closed loop phase noise divide-by-4 output ^{(1) (2) (3)} | $f_{VCO} = 1989\text{MHz}$, $f_O = 497.25\text{MHz}$ | 1kHz offset | | -95 | dBc/Hz |
| | | 600kHz offset | | -147.9 | |
| | | 1MHz offset | | -151.3 | |
| | | 10MHz offset | | -156 | |
| RMS phase error Closed loop phase noise divide-by-4 output ⁽³⁾ | 100Hz to 10MHz | | 0.252° | | |
| VCO gain, Kv | VCO free running | | 23 | | MHz/V |
| Reference spur ⁽²⁾ | | | -80 | | dBc |

 (1) See Application Circuit [Figure 87](#).

(2) PFD = 200kHz, Loop Filter BW = 15kHz, Output frequency step = 200kHz.

(3) Reference oscillator RMS phase error = 0.008250°, RMS jitter = 881.764 fs.

7.12 Electrical Characteristics, TRF3761-H

Supply voltage = $V_{CC} = 5\text{ V}$, $T_A = -40\text{ to }85^\circ\text{C}$ (unless otherwise noted)

| PARAMETER | TEST CONDITIONS | MIN | TYP | MAX | UNIT |
|---|--|---------------|-------|--------|--------|
| NOISE CHARACTERISTICS | | | | | |
| VCO phase noise, Free running VCO direct output | $f_{VCO} = 2116\text{MHz}$, $f_O = 2116\text{MHz}$ | 100kHz offset | | -116 | dBc/Hz |
| | | 600kHz offset | | -136 | |
| | | 1MHz offset | | -142 | |
| | | 6MHz offset | | -154.2 | |
| | | 10MHz offset | | -156 | |
| VCO phase noise, Free running VCO divide-by-2 output | $f_{VCO} = 2116\text{MHz}$, $f_O = 1058$ | 100kHz offset | | -123.3 | dBc/Hz |
| | | 600kHz offset | | -143 | |
| | | 1MHz offset | | -147.6 | |
| | | 6MHz offset | | -157 | |
| | | 10MHz offset | | -158.3 | |
| VCO phase noise, Free running VCO divide-by-4 output | $f_{VCO} = 2116\text{MHz}$, $f_O = 529\text{MHz}$ | 100kHz offset | | -129.4 | dBc/Hz |
| | | 600kHz offset | | -149.8 | |
| | | 1MHz offset | | -152.7 | |
| | | 6MHz offset | | -157.7 | |
| | | 10MHz offset | | -158 | |
| VCO phase noise, Closed loop phase noise direct output ^{(1) (2) (3)} | $f_{VCO} = 2116\text{MHz}$, $f_O = 2116\text{MHz}$ | 1kHz offset | | -84 | dBc/Hz |
| | | 600kHz offset | | -136 | |
| | | 1MHz offset | | -141 | |
| | | 10MHz offset | | -157 | |
| RMS phase error Closed loop phase noise direct output ⁽³⁾ | 100Hz to 10MHz | | 0.99° | | |
| VCO phase noise, Closed loop phase noise divide-by-2 output ^{(1) (2) (3)} | $f_{VCO} = 2116\text{MHz}$, $f_O = 1058\text{MHz}$ | 1kHz offset | | -89 | dBc/Hz |
| | | 600kHz offset | | -143 | |
| | | 1MHz offset | | -148 | |
| | | 10MHz offset | | -159 | |
| RMS phase error Closed loop phase noise divide-by-2 output ⁽³⁾ | 100Hz to 10MHz | | 0.54° | | |
| VCO phase noise, Closed loop phase noise divide-by-4 output ^{(1) (2) (3)} | $f_{VCO} = 2116\text{MHz}$, $f_O = 529\text{MHz}$ | 1kHz offset | | -95 | dBc/Hz |
| | | 600kHz offset | | -149.5 | |
| | | 1MHz offset | | -153 | |
| | | 10MHz offset | | -158 | |
| RMS phase error Closed loop phase noise divide-by-4 output ⁽³⁾ | 100Hz to 10MHz | | 0.35° | | |
| VCO gain, Kv | VCO free running | | 23 | | MHz/V |
| Reference spur ⁽²⁾ | | | -80 | | dBc |

(1) See Application Circuit [Figure 87](#).

(2) PFD = 200kHz, Loop Filter BW = 15kHz, Output frequency step = 200kHz.

(3) Reference oscillator RMS phase error = 0.008250°, RMS jitter = 881.764 fs.

7.13 Electrical Characteristics, TRF3761-J

 Supply voltage = $V_{CC} = 5\text{ V}$, $T_A = -40\text{ to }85^\circ\text{C}$ (unless otherwise noted)

| PARAMETER | TEST CONDITIONS | MIN | TYP | MAX | UNIT |
|---|--|---------------|-------|--------|--------|
| NOISE CHARACTERISTICS | | | | | |
| VCO phase noise, Free running VCO direct output | $f_{VCO} = 2289\text{MHz}$, $f_O = 2289\text{MHz}$ | 100kHz offset | | -116.7 | dBc/Hz |
| | | 600kHz offset | | -135.4 | |
| | | 1MHz offset | | -141 | |
| | | 6MHz offset | | -153.8 | |
| | | 10MHz offset | | -156.4 | |
| VCO phase noise, Free running VCO divide-by-2 output | $f_{VCO} = 2289\text{MHz}$, $f_O = 1144.5$ | 100kHz offset | | -123 | dBc/Hz |
| | | 600kHz offset | | -142 | |
| | | 1MHz offset | | -147 | |
| | | 6MHz offset | | -156.2 | |
| | | 10MHz offset | | -157.5 | |
| VCO phase noise, Free running VCO divide-by-4 output | $f_{VCO} = 2289\text{MHz}$, $f_O = 572.25\text{MHz}$ | 100kHz offset | | -129 | dBc/Hz |
| | | 600kHz offset | | -149 | |
| | | 1MHz offset | | -153 | |
| | | 6MHz offset | | -157.5 | |
| | | 10MHz offset | | -158 | |
| VCO phase noise, Closed loop phase noise direct output ^{(1) (2) (3)} | $f_{VCO} = 2289\text{MHz}$, $f_O = 2289\text{MHz}$ | 1kHz offset | | -83 | dBc/Hz |
| | | 600kHz offset | | -135 | |
| | | 1MHz offset | | -140 | |
| | | 10MHz offset | | -156 | |
| RMS phase error Closed loop phase noise direct output ⁽³⁾ | 100Hz to 10MHz | | 1.1° | | |
| VCO phase noise, Closed loop phase noise divide-by-2 output ^{(1) (2) (3)} | $f_{VCO} = 2289\text{MHz}$, $f_O = 1144.5\text{MHz}$ | 1kHz offset | | -89 | dBc/Hz |
| | | 600kHz offset | | -141 | |
| | | 1MHz offset | | -145.7 | |
| | | 10MHz offset | | -158 | |
| RMS phase error Closed loop phase noise divide-by-2 output ⁽³⁾ | 100Hz to 10MHz | | 0.59° | | |
| VCO phase noise, Closed loop phase noise divide-by-4 output ^{(1) (2) (3)} | $f_{VCO} = 2289\text{MHz}$, $f_O = 572.25\text{MHz}$ | 1kHz offset | | -95 | dBc/Hz |
| | | 600kHz offset | | -148 | |
| | | 1MHz offset | | -152 | |
| | | 10MHz offset | | -158.1 | |
| RMS phase error Closed loop phase noise divide-by-4 output ⁽³⁾ | 100Hz to 10MHz | | 0.37° | | |
| VCO gain, Kv | VCO free running | | 23 | | MHz/V |
| Reference spur ⁽²⁾ | | | -80 | | dBc |

 (1) See Application Circuit [Figure 87](#).

(2) PFD = 200kHz, Loop Filter BW = 15kHz, Output frequency step = 200kHz.

(3) Reference oscillator RMS phase error = 0.008250°, RMS jitter = 881.764 fs.

7.14 Timing Requirements

Supply voltage = $V_{CC} = 4.5\text{ V to }5.25\text{ V}$, $T_A = -40\text{ to }85\text{ }^\circ\text{C}$

| | | MIN | TYP | MAX | UNIT |
|-------------|---------------------|-----|-----|-----|------|
| $t_{(CLK)}$ | Clock period | 50 | | | ns |
| t_{su1} | Setup time, data | 10 | | | ns |
| t_h | Hold time, data | 10 | | | ns |
| t_w | Pulse width, STROBE | 20 | | | ns |
| t_{su2} | Setup time, STROBE | 10 | | | ns |

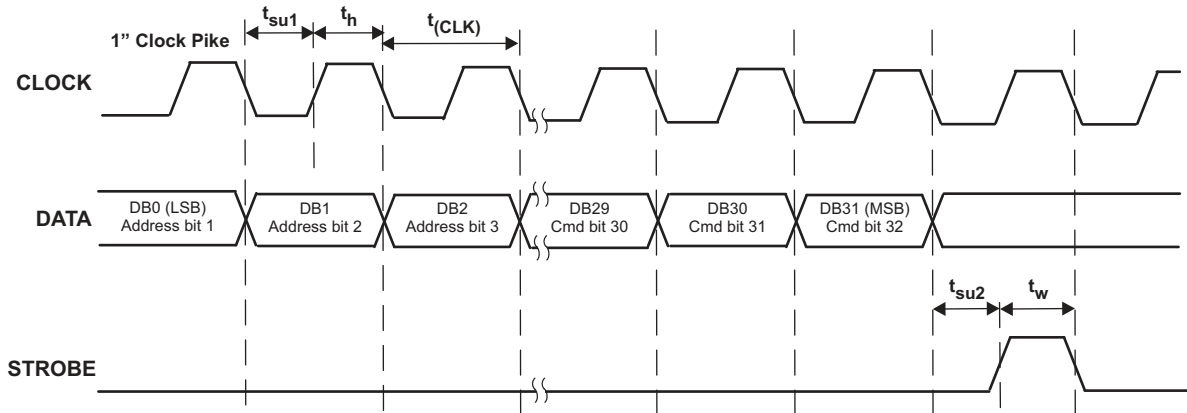

- A. The first 4 bits, DB(3-0), of data are Address bits. The 28 remaining bits, DB(31-4), are part of the command. The command is little endian or lower bits first.

Figure 1. Serial Programming Timing Diagram

7.15 Typical Characteristics

7.15.1 Typical Characteristics, TRF3761-A (See Figure 87)

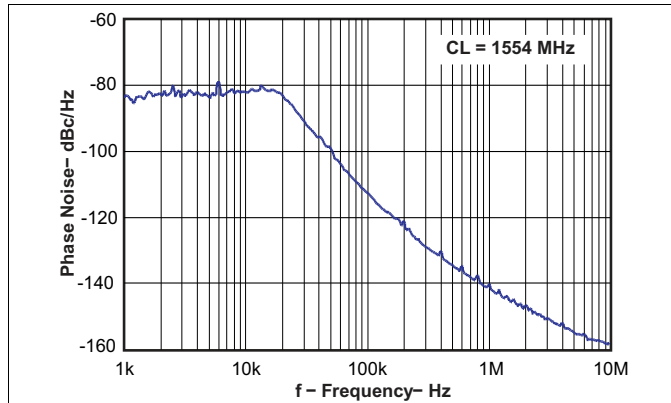

Figure 2. Closed Loop VCO Phase Noise

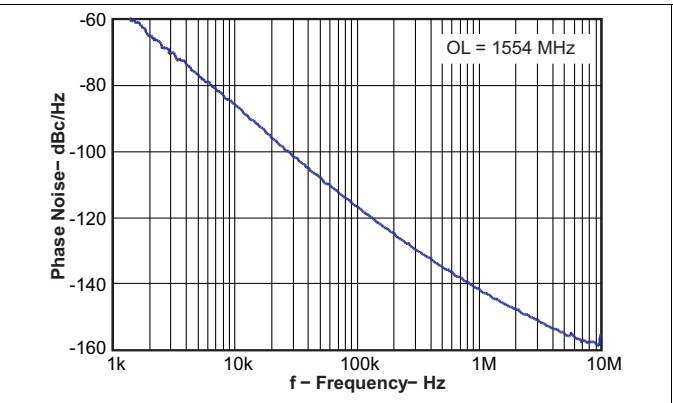

Figure 3. Open Loop VCO Phase Noise

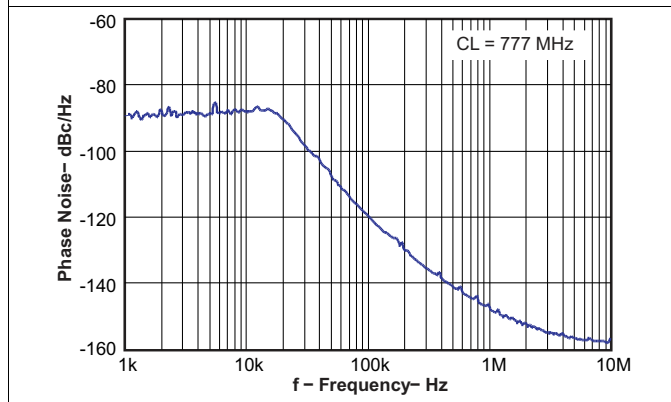

Figure 4. Closed Loop VCO Phase Noise

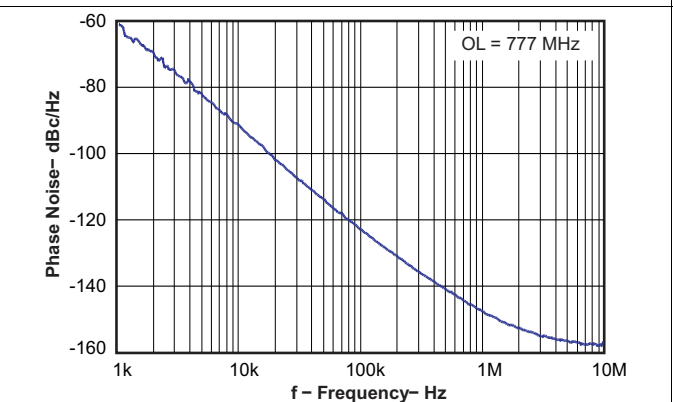

Figure 5. Open Loop VCO Phase Noise

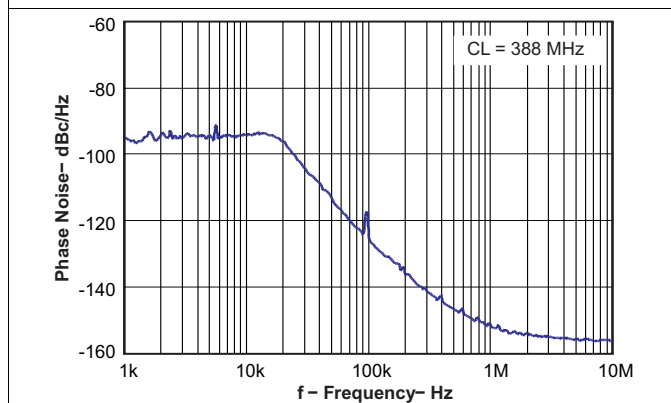

Figure 6. Closed Loop VCO Phase Noise

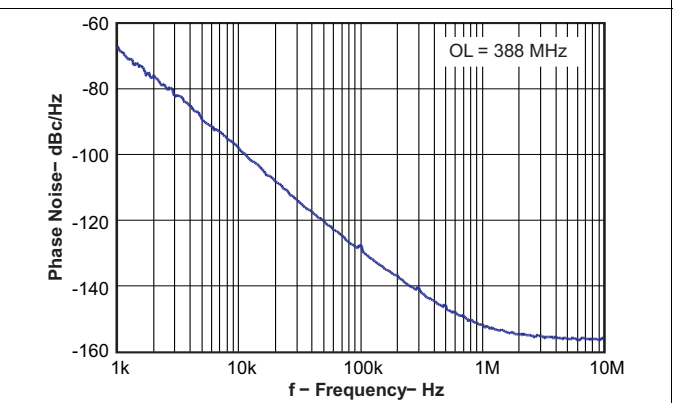
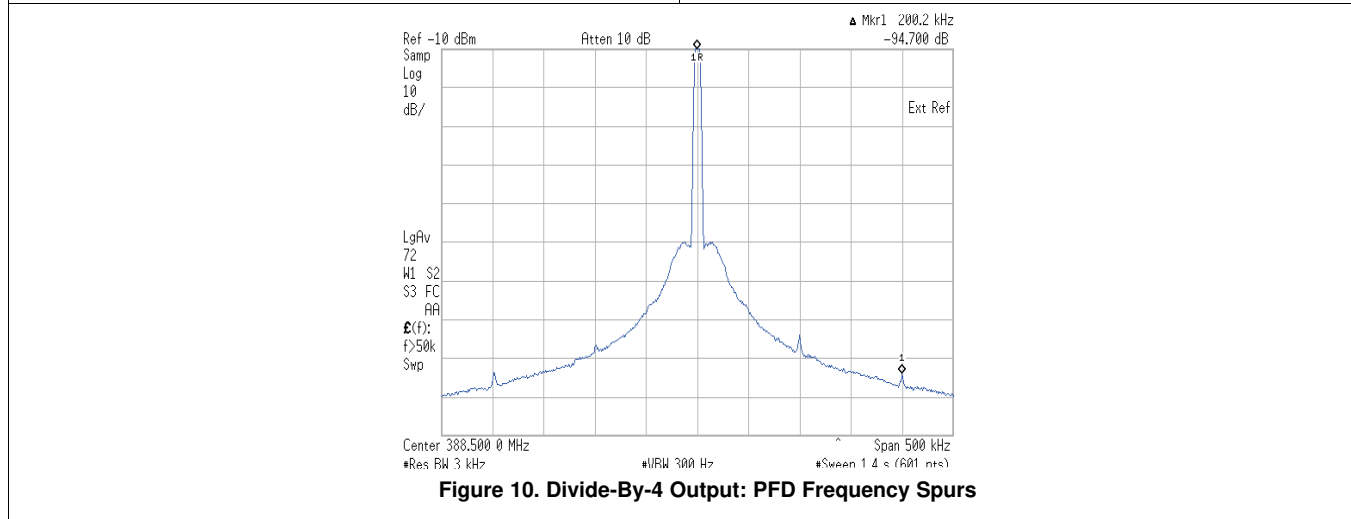
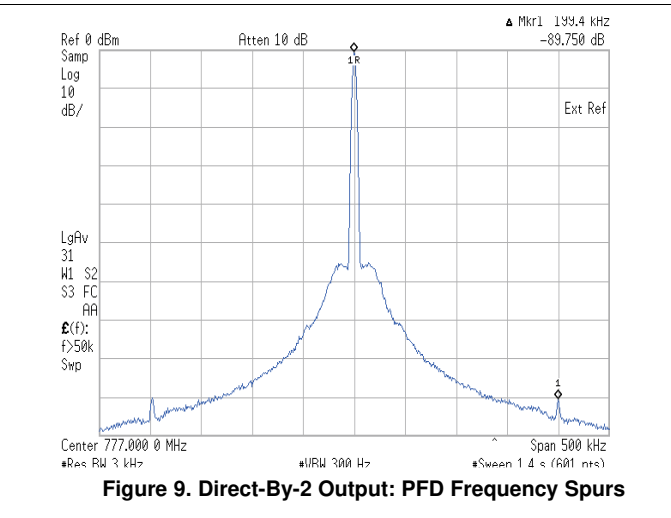
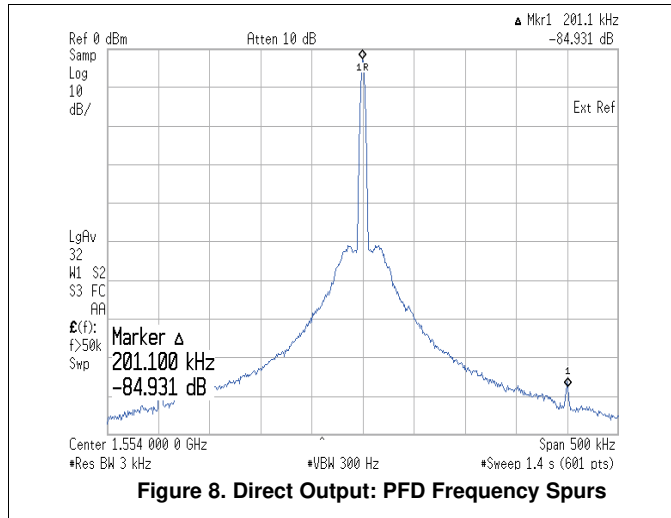

Figure 7. Open Loop VCO Phase Noise

Typical Characteristics, TRF3761-A (See Figure 87) (continued)



7.15.2 Typical Characteristics, TRF3761-B (See Figure 87)

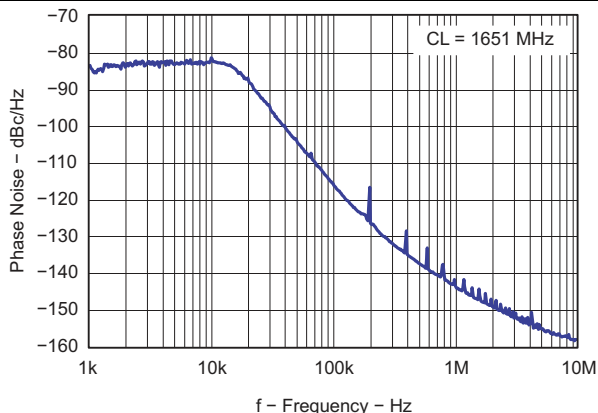

Figure 11. Closed Loop VCO Phase Noise

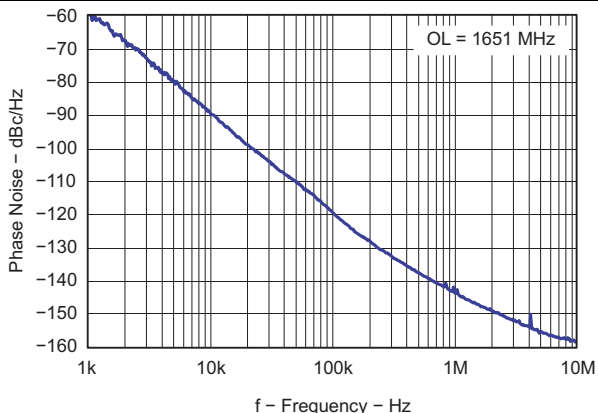

Figure 12. Open Loop VCO Phase Noise

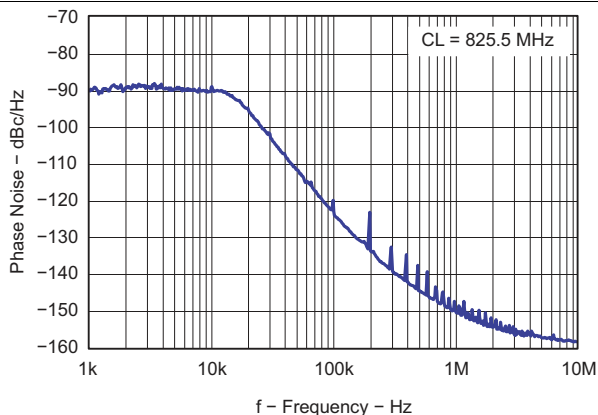

Figure 13. Closed Loop VCO Phase Noise

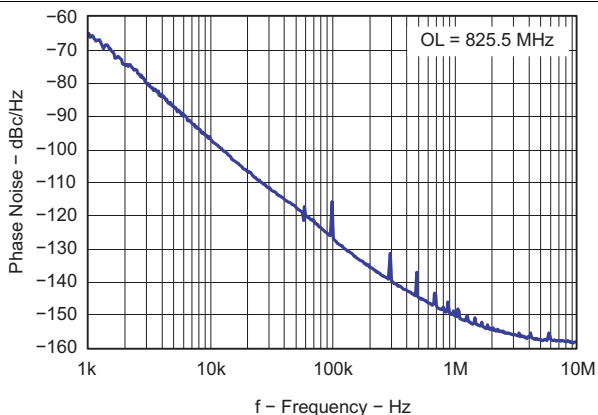

Figure 14. Open Loop VCO Phase Noise

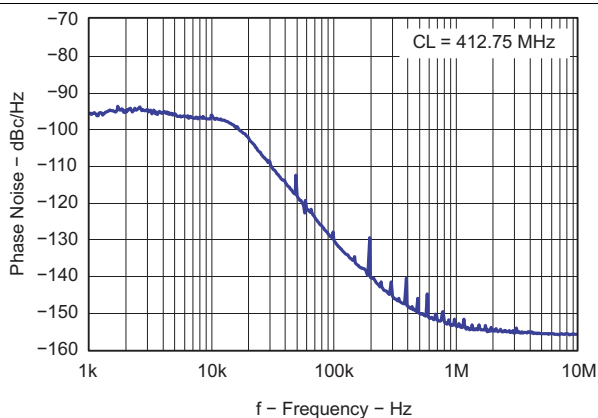

Figure 15. Closed Loop VCO Phase Noise

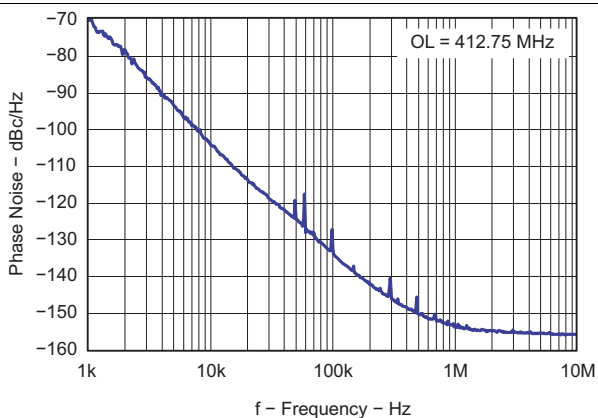
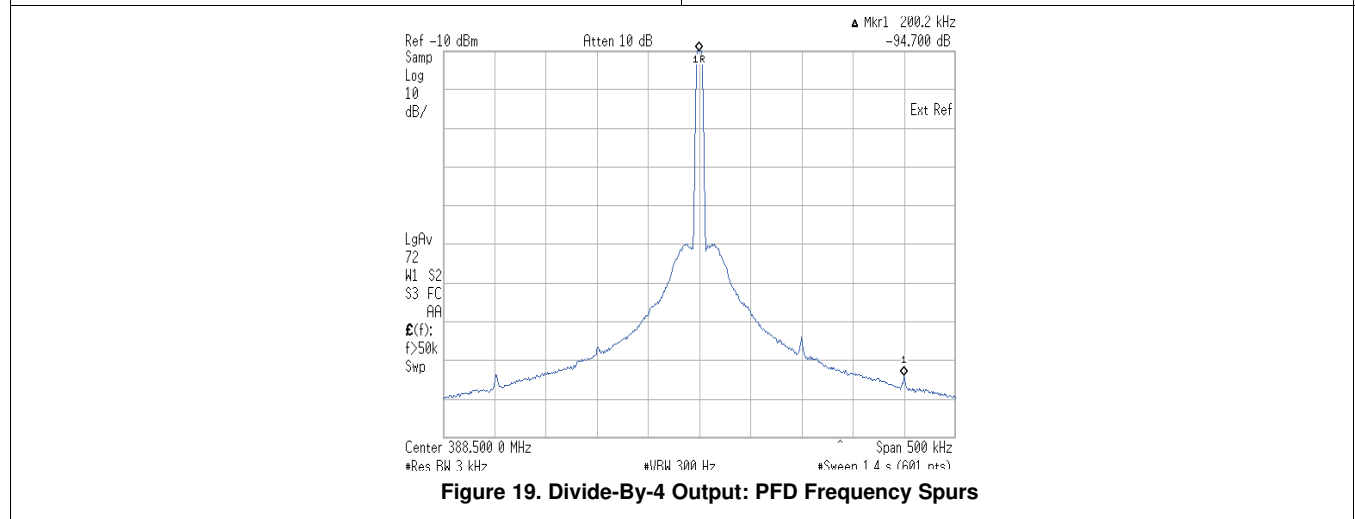
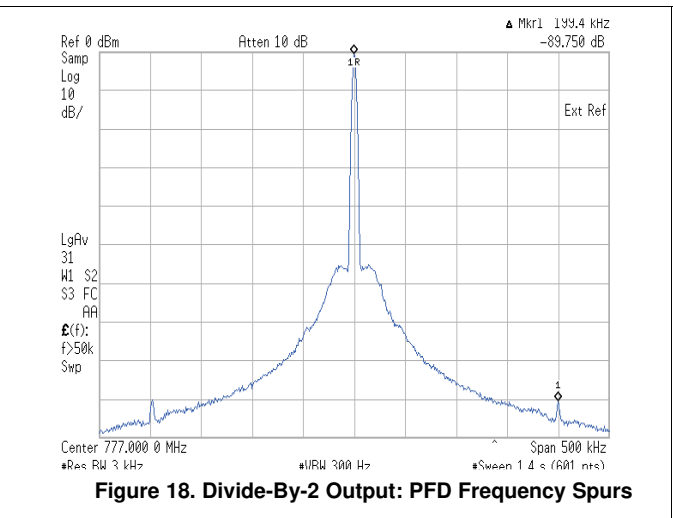
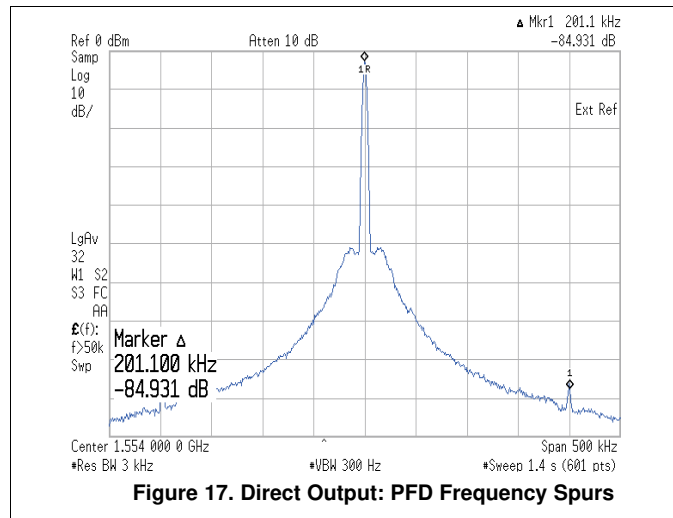

Figure 16. Open Loop VCO Phase Noise

Typical Characteristics, TRF3761-B (See Figure 87) (continued)



7.15.3 Typical Characteristics, TRF3761-C (See Figure 87)

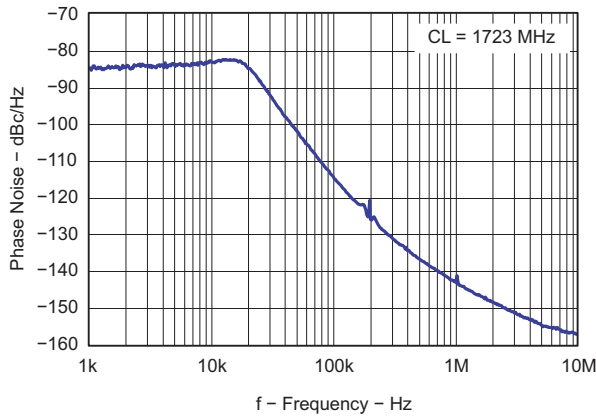

Figure 20. Closed Loop VCO Phase Noise

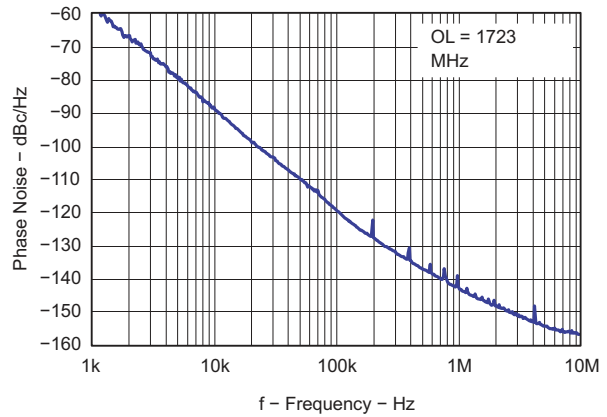

Figure 21. Open Loop VCO Phase Noise

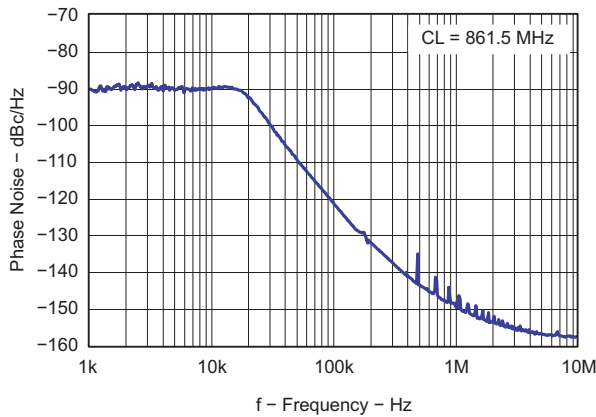

Figure 22. Closed Loop VCO Phase Noise

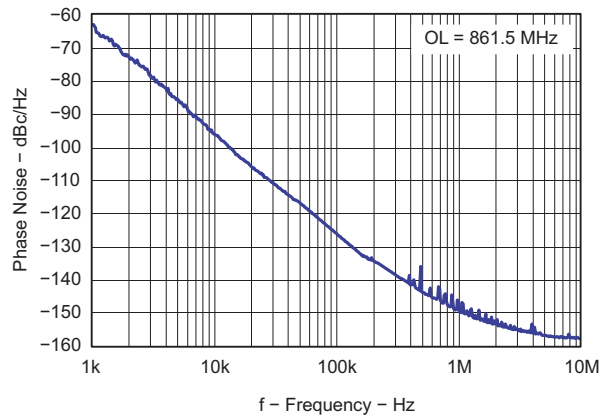

Figure 23. Open Loop VCO Phase Noise

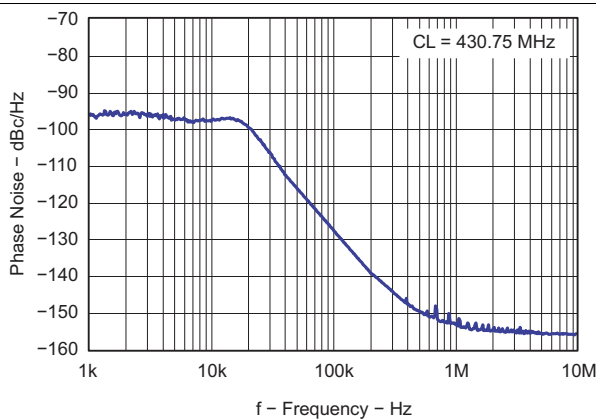

Figure 24. Closed Loop VCO Phase Noise

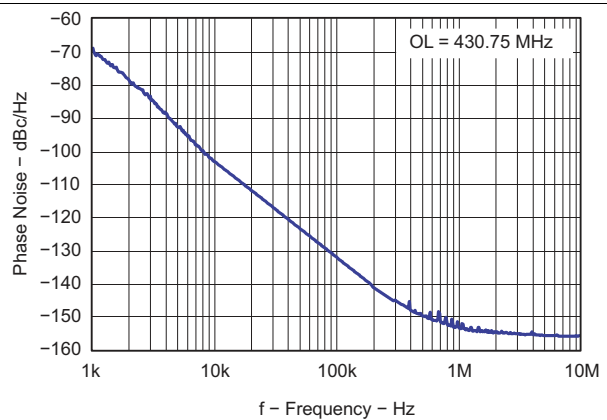

Figure 25. Open Loop VCO Phase Noise

Typical Characteristics, TRF3761-C (See Figure 87) (continued)

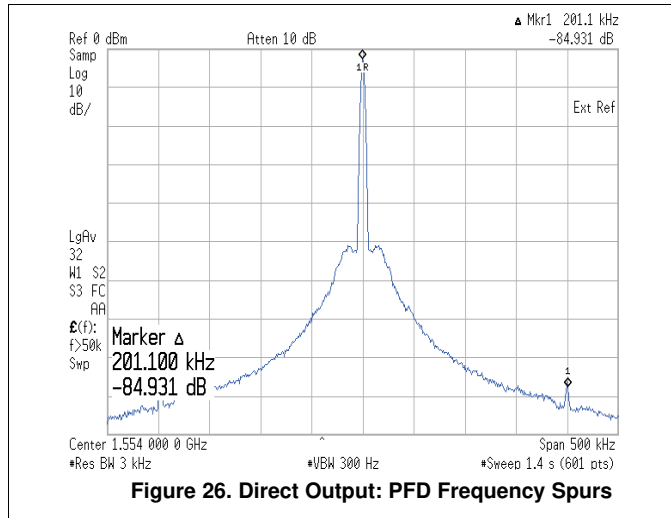

Figure 26. Direct Output: PFD Frequency Spurs

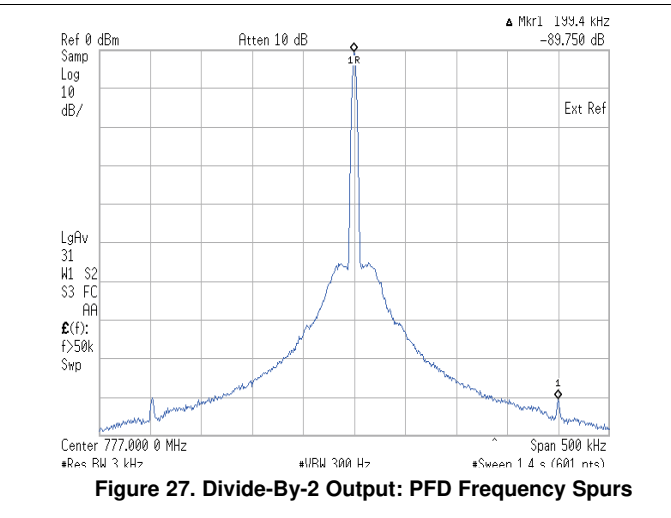

Figure 27. Divide-By-2 Output: PFD Frequency Spurs

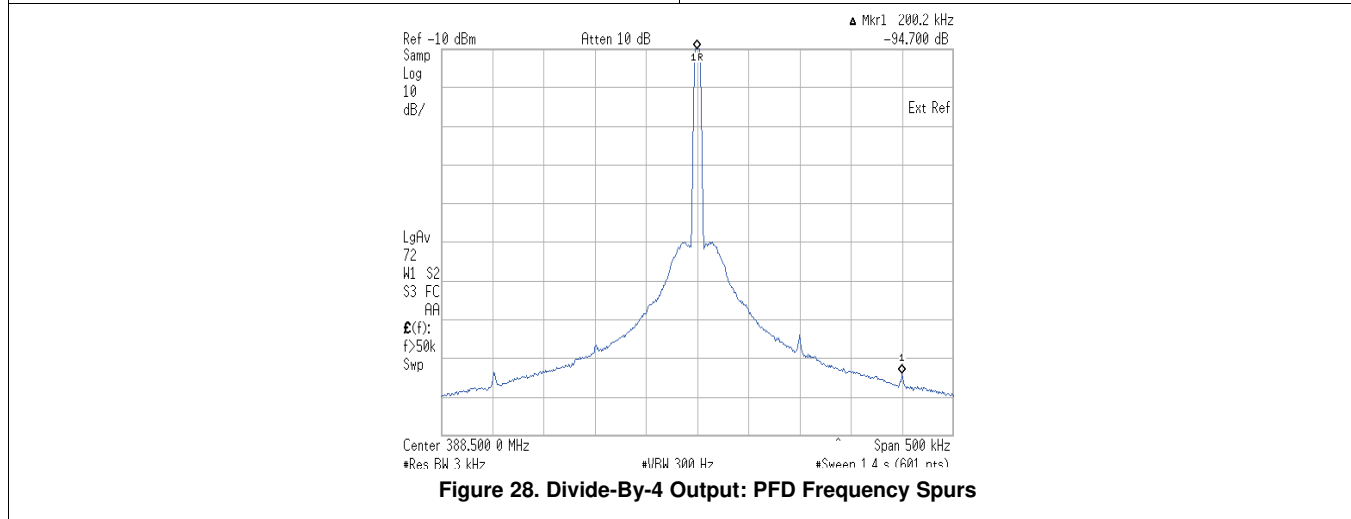

Figure 28. Divide-By-4 Output: PFD Frequency Spurs

7.15.4 Typical Characteristics, TRF3761-D (See [Figure 87](#))

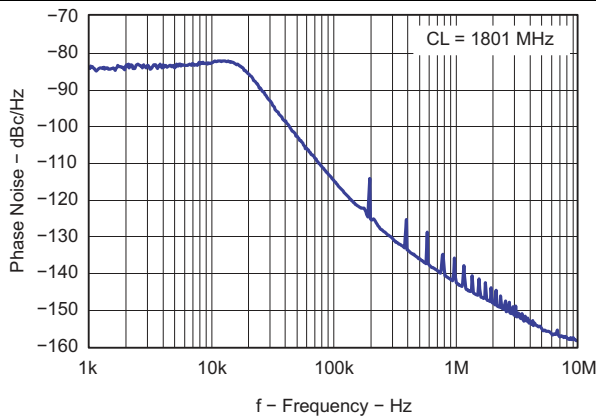

Figure 29. Closed Loop VCO Phase Noise

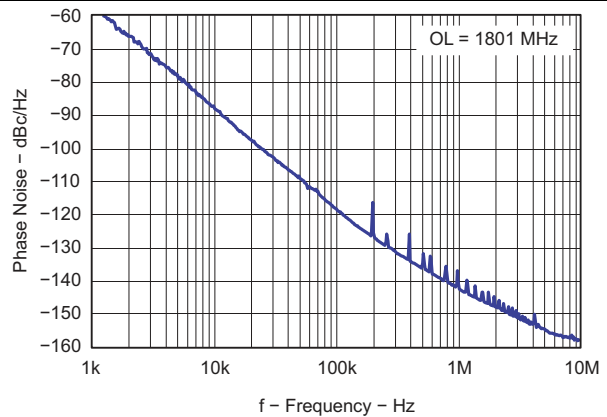

Figure 30. Open Loop VCO Phase Noise

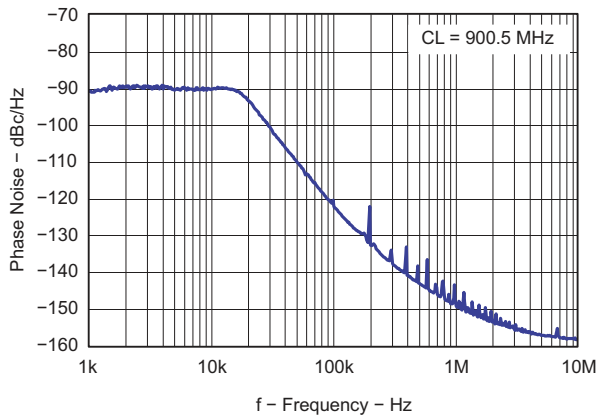

Figure 31. Closed Loop VCO Phase Noise

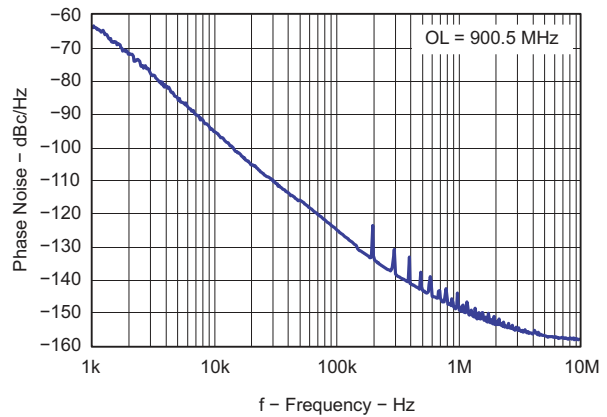

Figure 32. Open Loop VCO Phase Noise

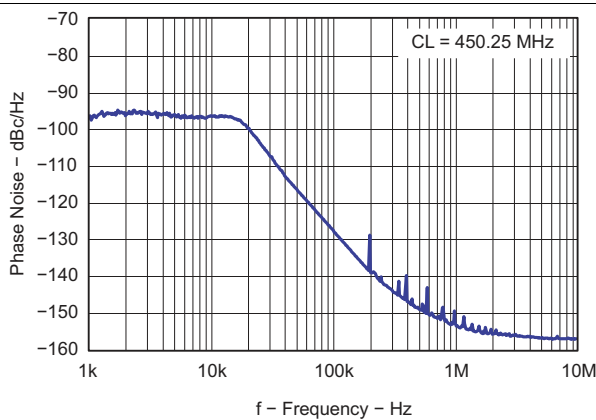

Figure 33. Closed Loop VCO Phase Noise

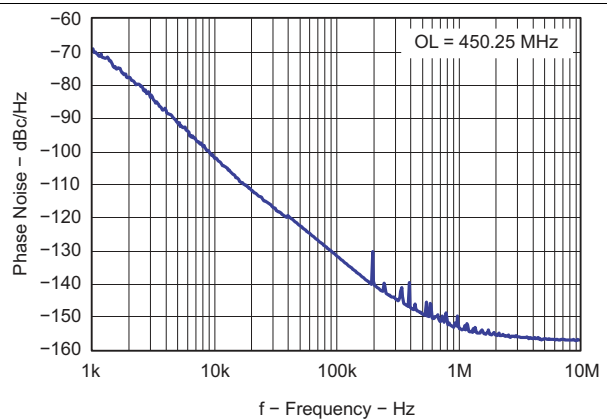
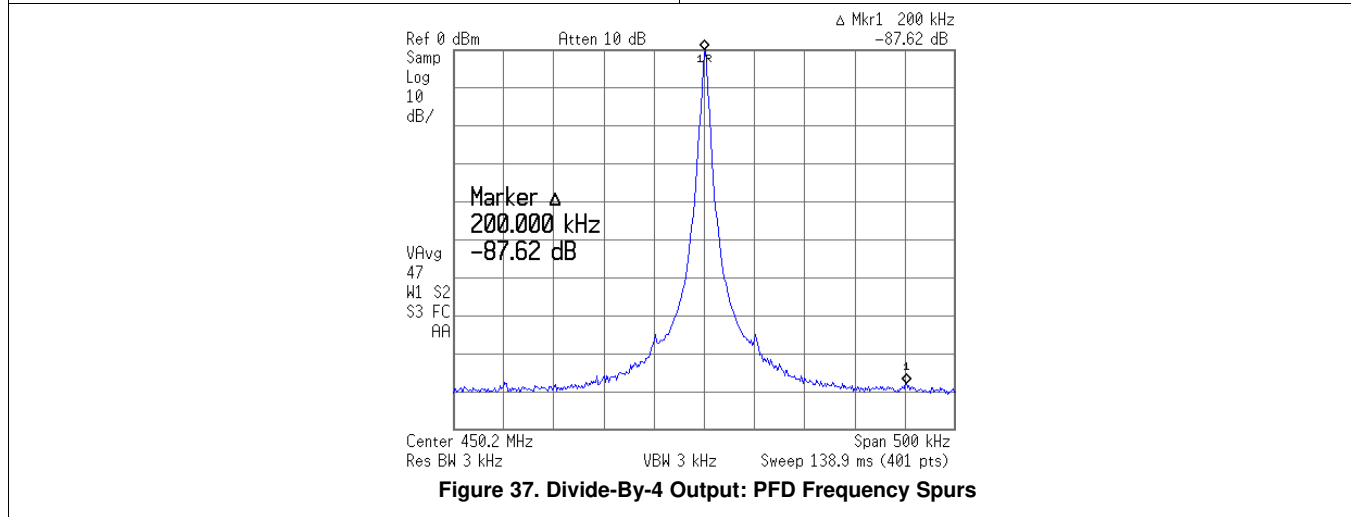
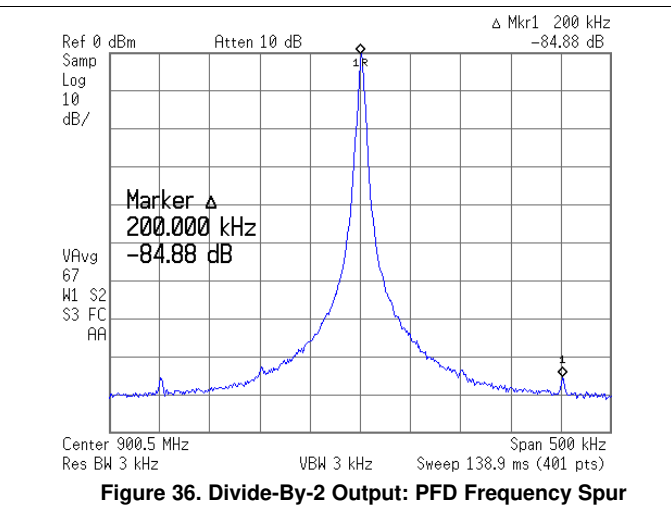
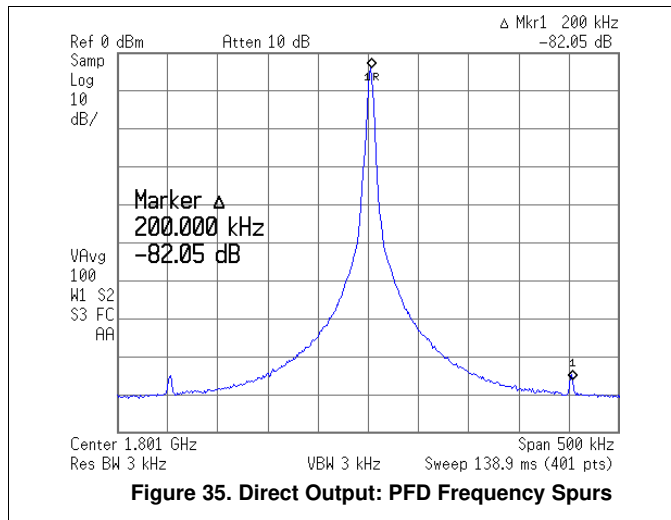

Figure 34. Open Loop VCO Phase Noise

Typical Characteristics, TRF3761-D (See Figure 87) (continued)



7.15.5 Typical Characteristics, TRF3761-E (See Figure 87)

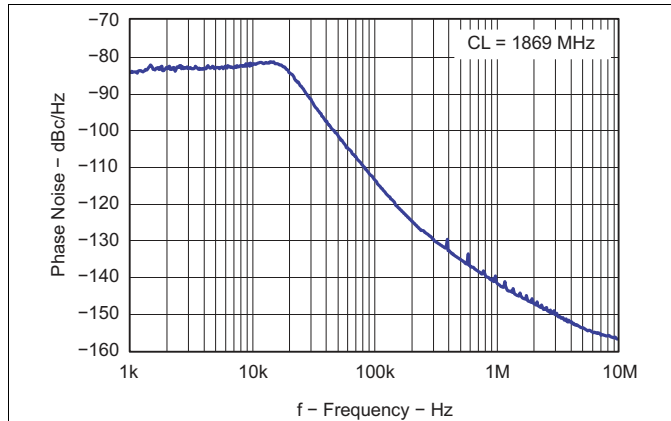

Figure 38. Closed Loop VCO Phase Noise

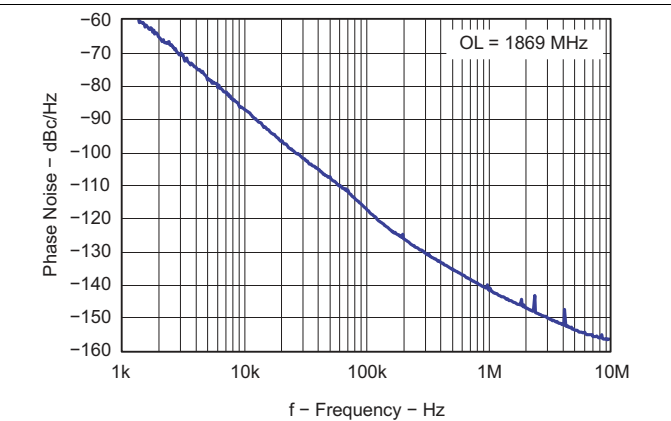

Figure 39. Open Loop VCO Phase Noise

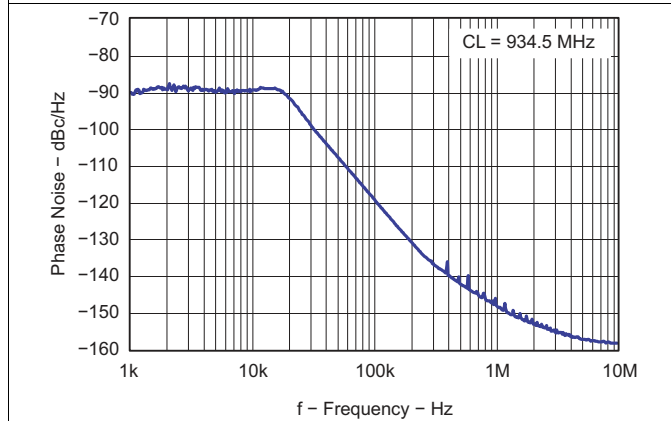

Figure 40. Closed Loop VCO Phase Noise

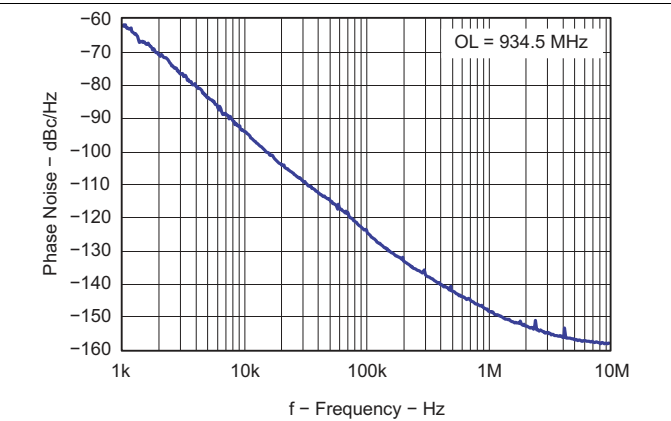

Figure 41. Open Loop VCO Phase Noise

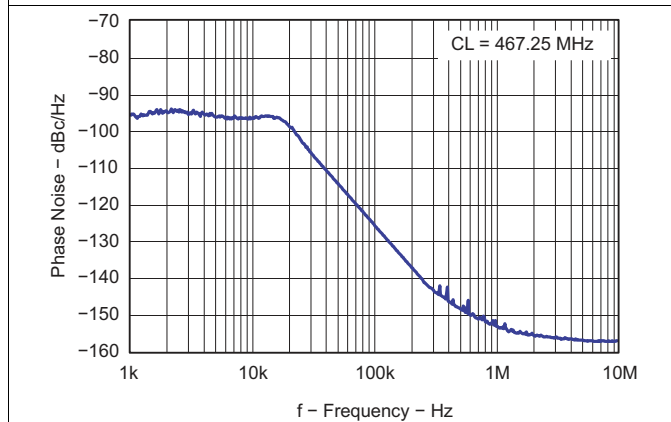

Figure 42. Closed Loop VCO Phase Noise

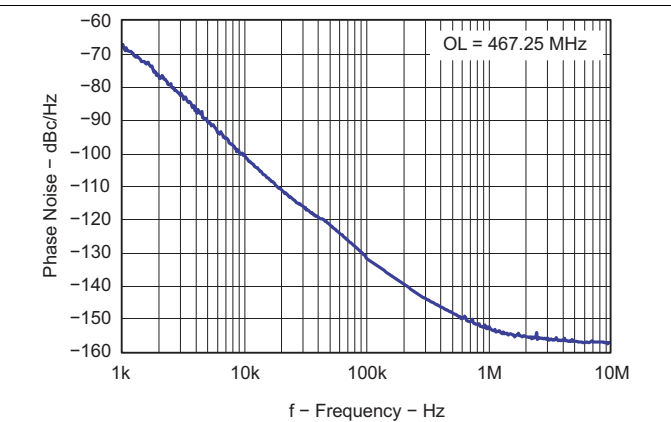

Figure 43. Open Loop VCO Phase Noise

Typical Characteristics, TRF3761-E (See [Figure 87](#)) (continued)

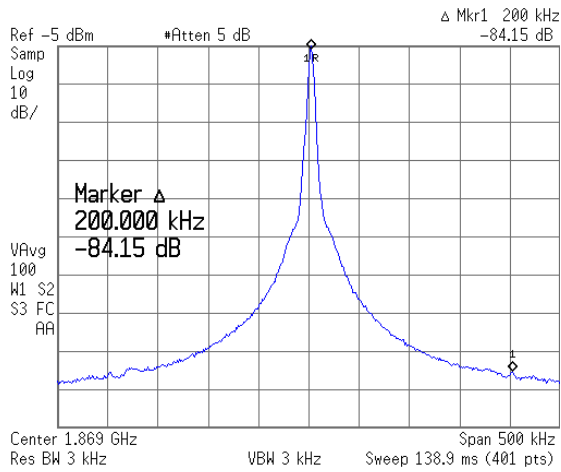

Figure 44. Direct Output: PFD Frequency Spurs

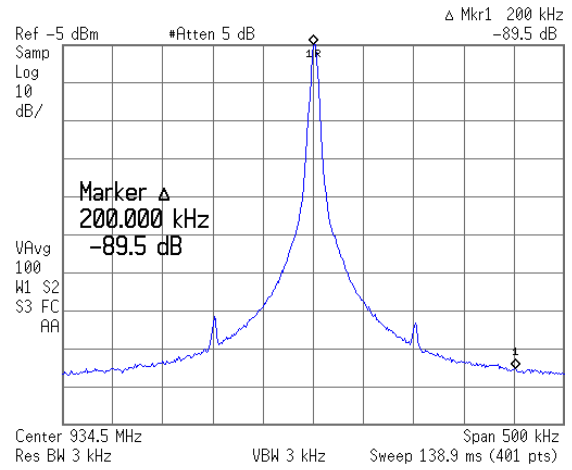

Figure 45. Divide-By-2 Output: PFD Frequency Spurs

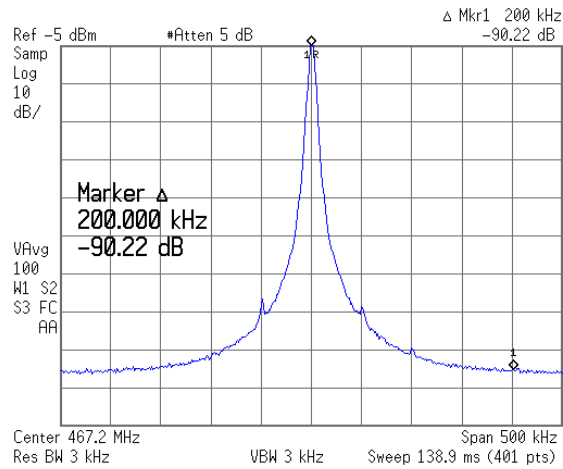

Figure 46. Divide-By-4 Output: PFD Frequency Spurs

7.15.6 Typical Characteristics, TRF3761-F (See Figure 87)

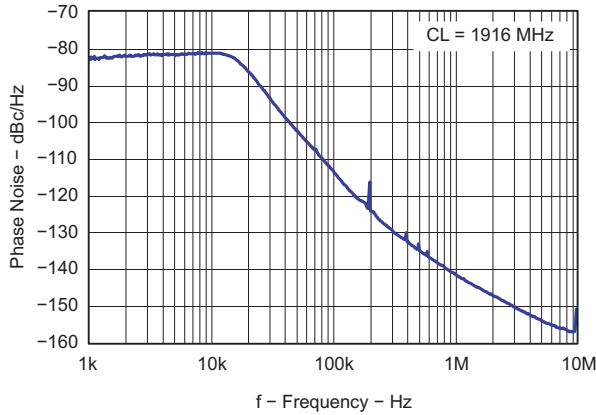

Figure 47. Closed Loop VCO Phase Noise

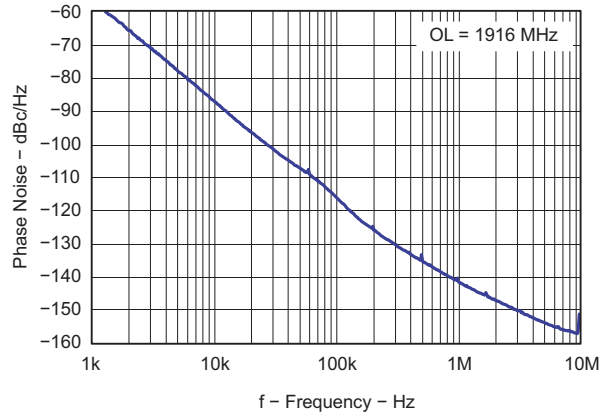

Figure 48. Open Loop VCO Phase Noise

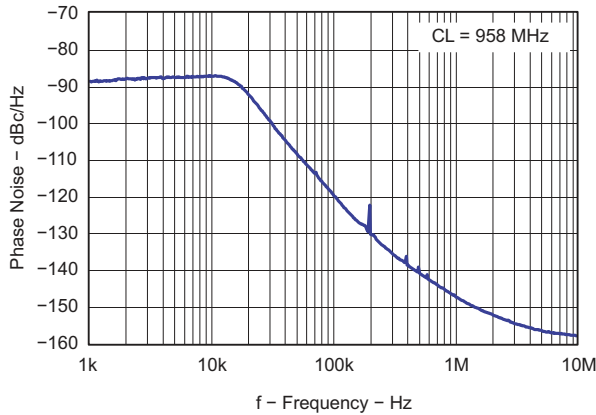

Figure 49. Closed Loop VCO Phase Noise

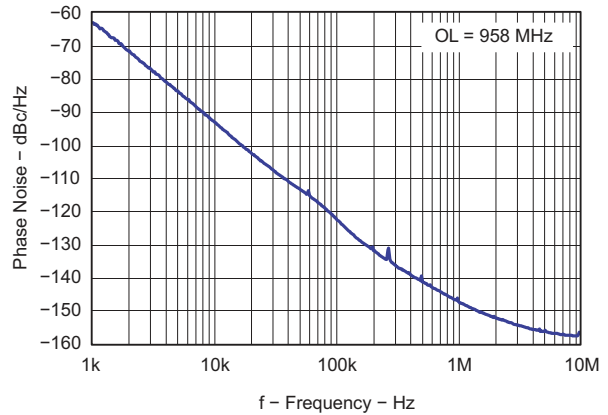

Figure 50. Open Loop VCO Phase Noise

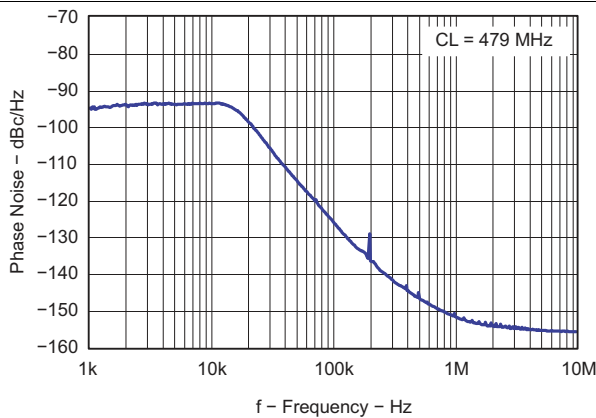

Figure 51. Closed Loop VCO Phase Noise

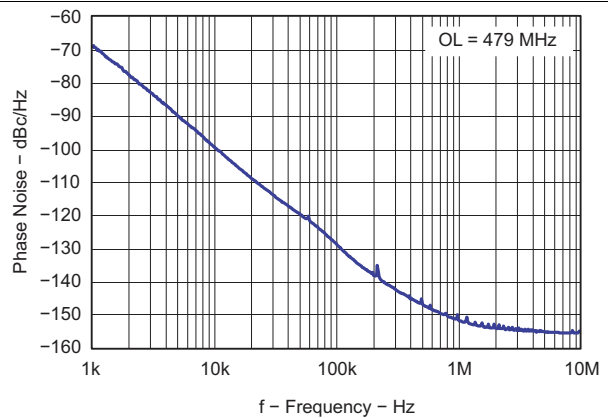
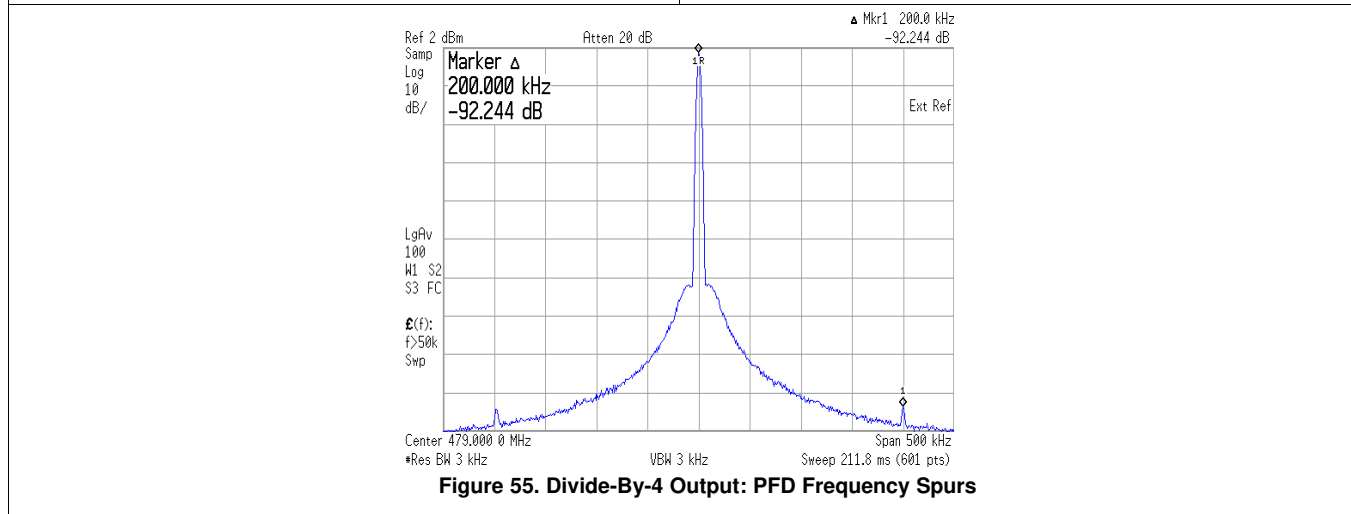
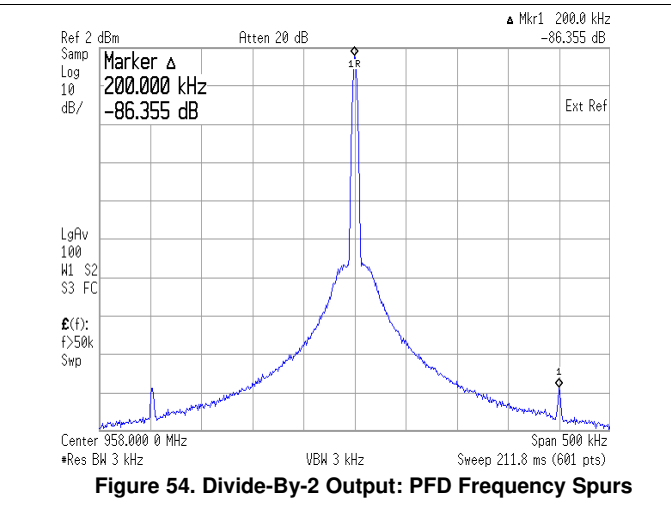
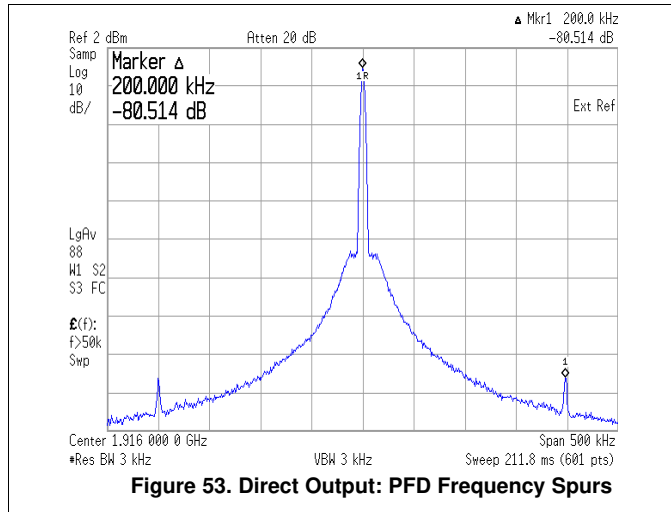

Figure 52. Open Loop VCO Phase Noise

Typical Characteristics, TRF3761-F (See Figure 87) (continued)



7.15.7 Typical Characteristics, TRF3761-G (See Figure 87)

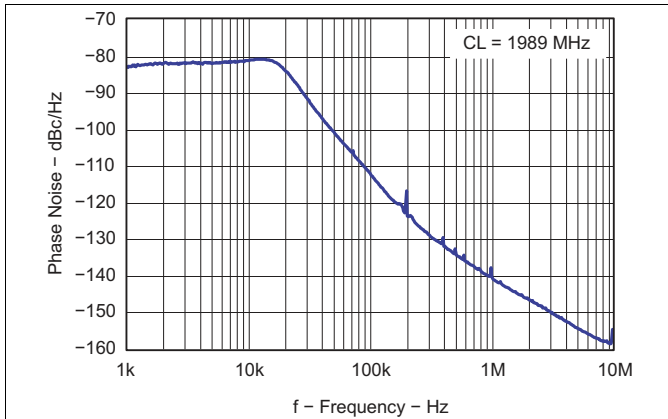

Figure 56. Closed Loop VCO Phase Noise

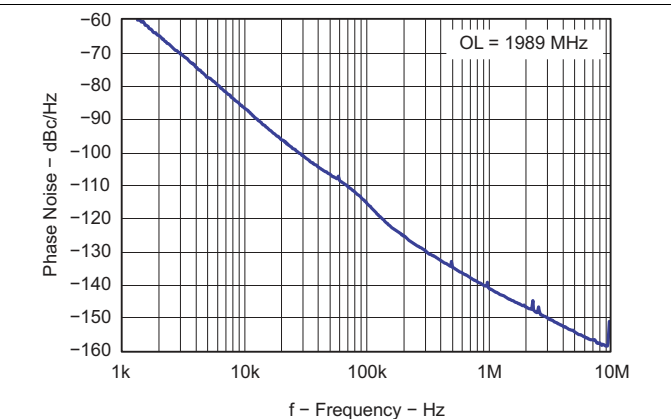

Figure 57. Open Loop VCO Phase Noise

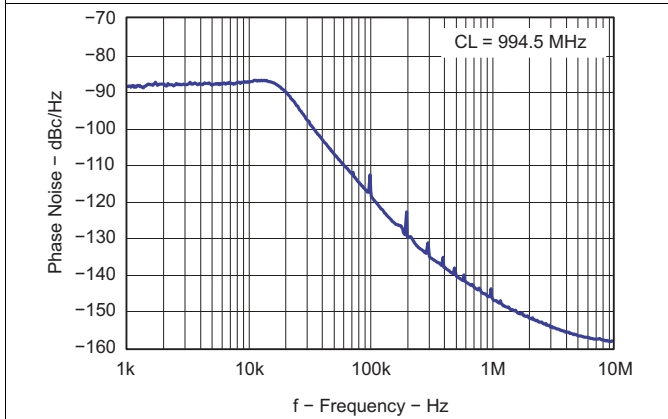

Figure 58. Closed Loop VCO Phase Noise

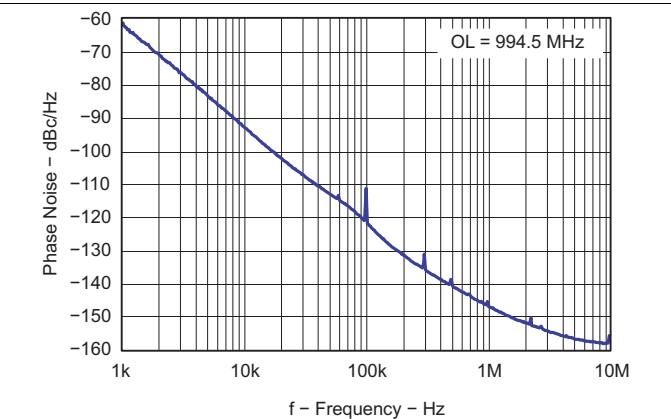

Figure 59. Open Loop VCO Phase Noise

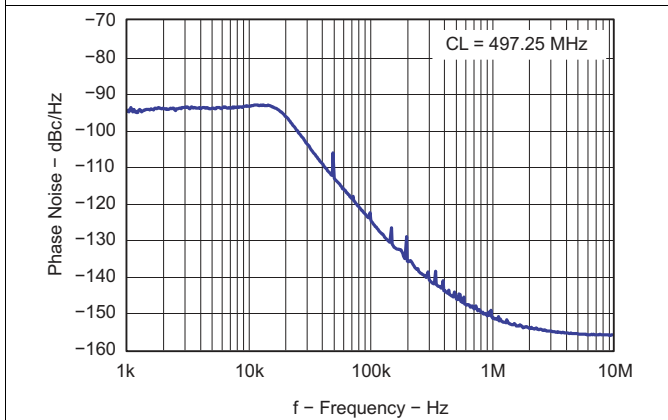

Figure 60. Closed Loop VCO Phase Noise

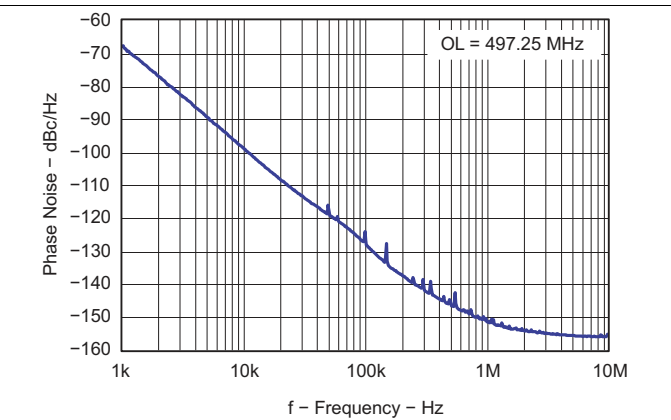
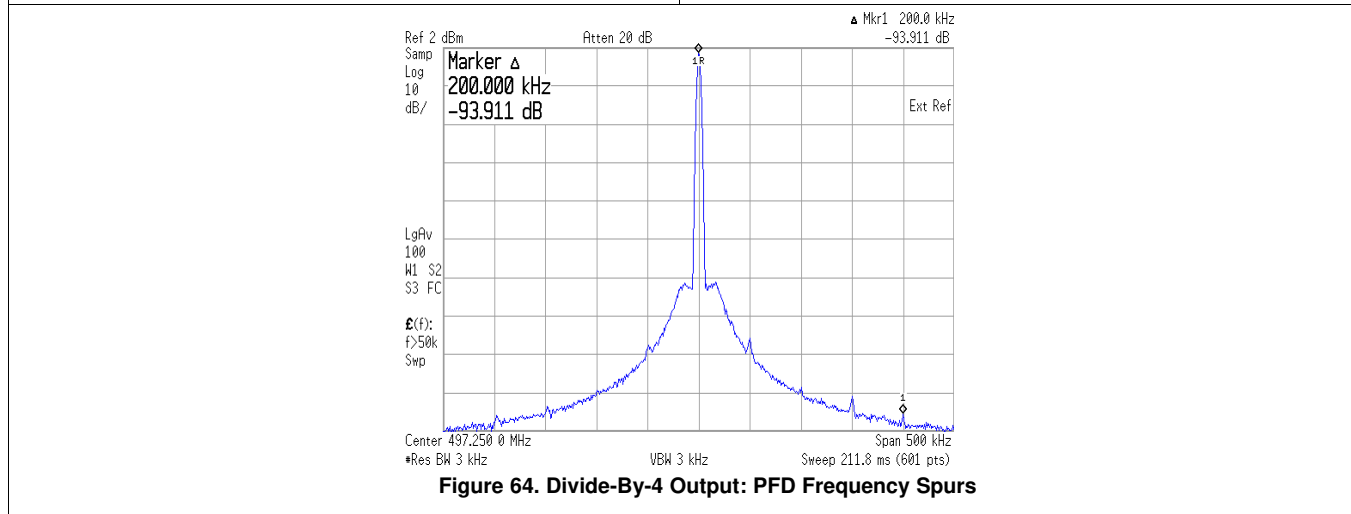
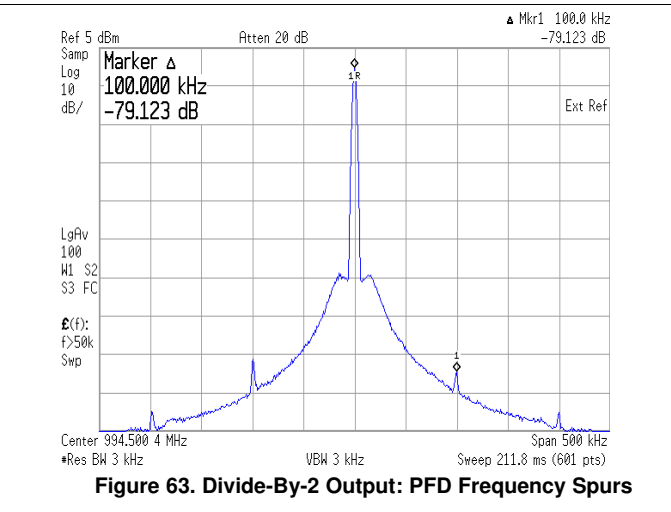
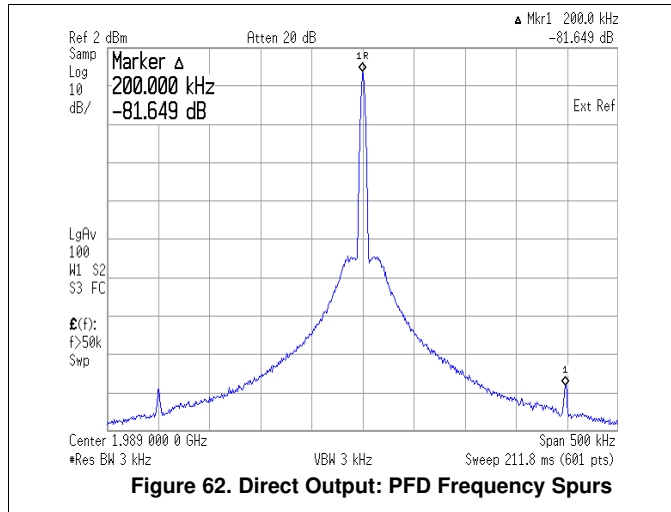

Figure 61. Open Loop VCO Phase Noise

Typical Characteristics, TRF3761-G (See Figure 87) (continued)



7.15.8 Typical Characteristics, TRF3761-H (See Figure 87)

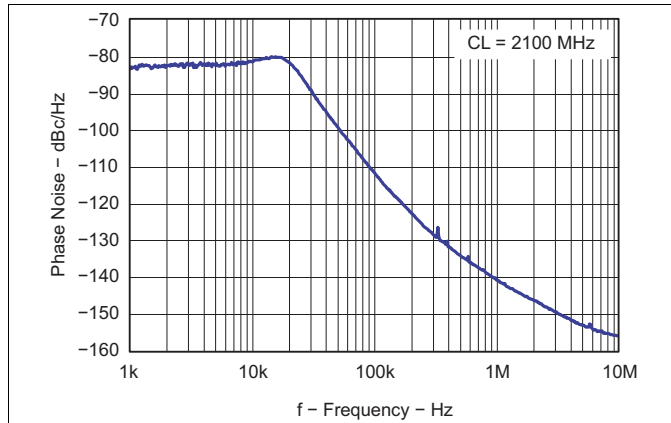

Figure 65. Closed Loop VCO Phase Noise

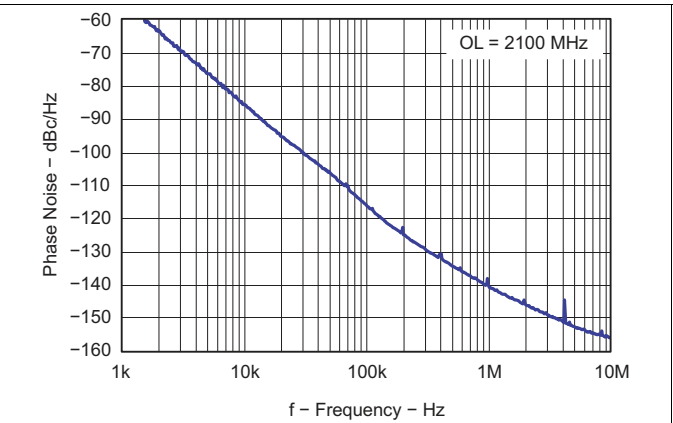

Figure 66. Open Loop VCO Phase Noise

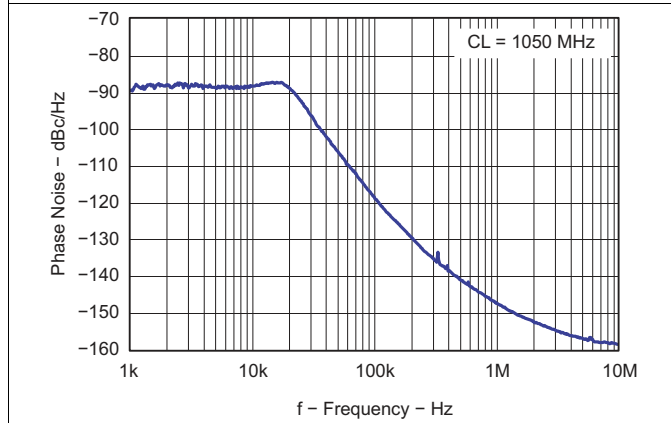

Figure 67. Closed Loop VCO Phase Noise

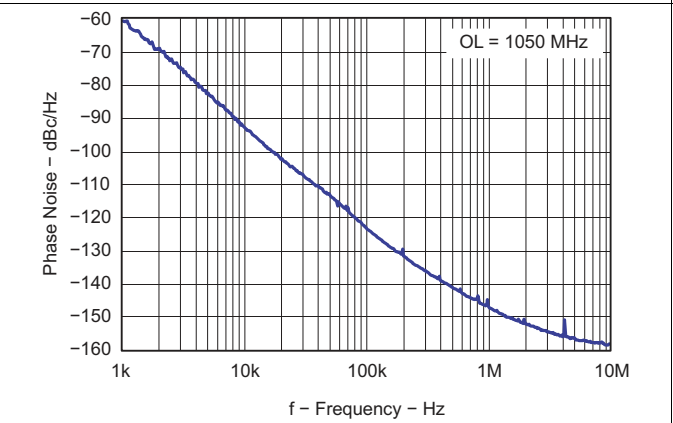

Figure 68. Open Loop VCO Phase Noise

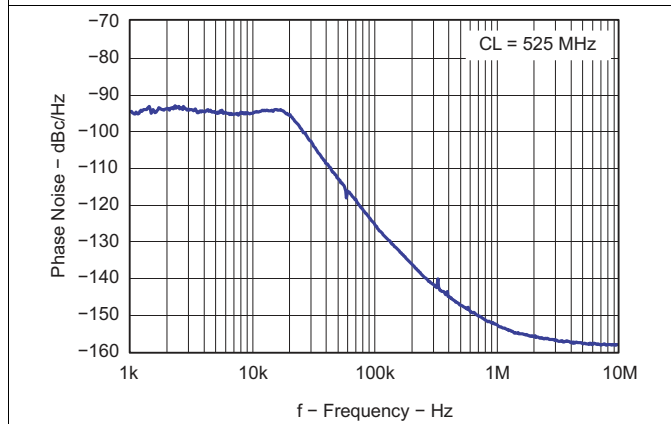

Figure 69. Closed Loop VCO Phase Noise

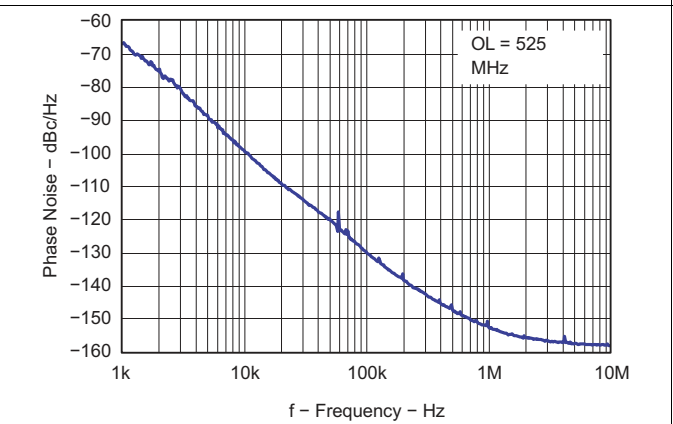
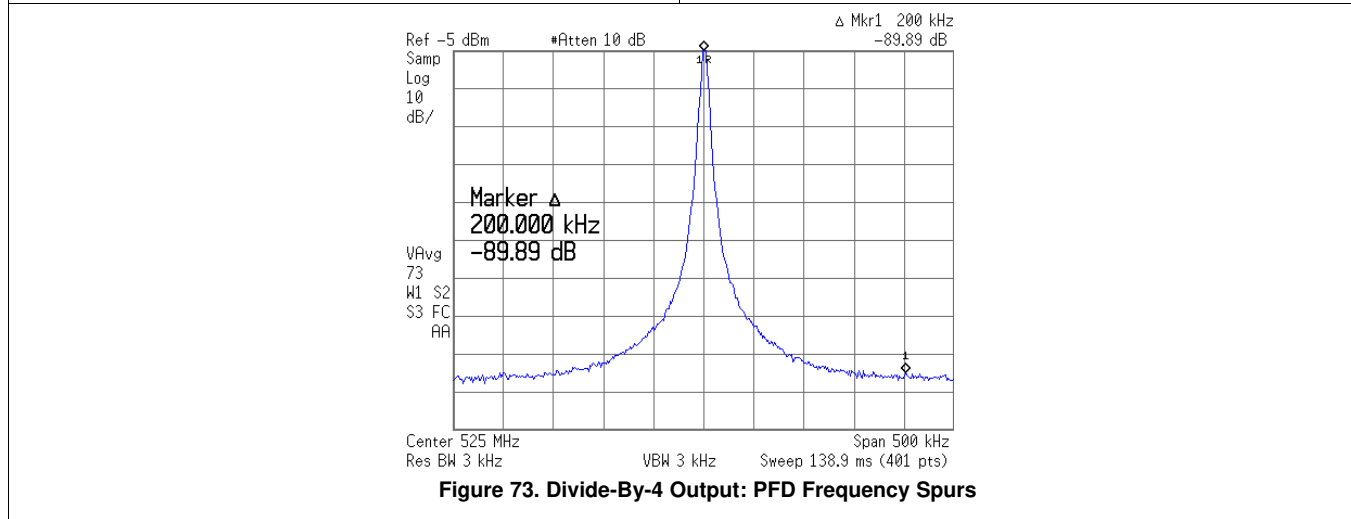
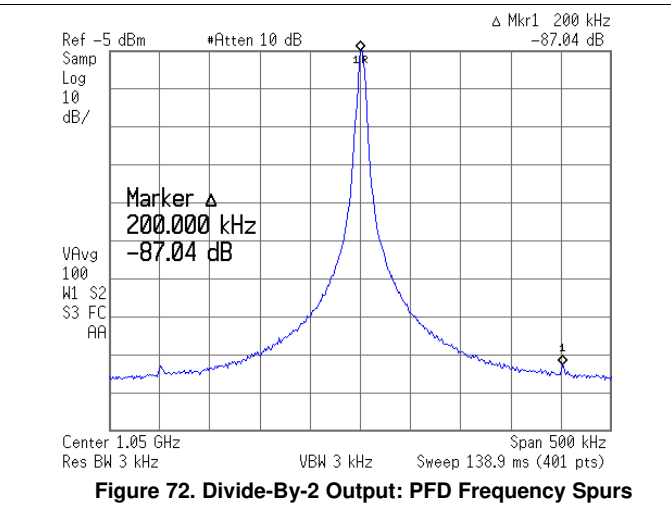
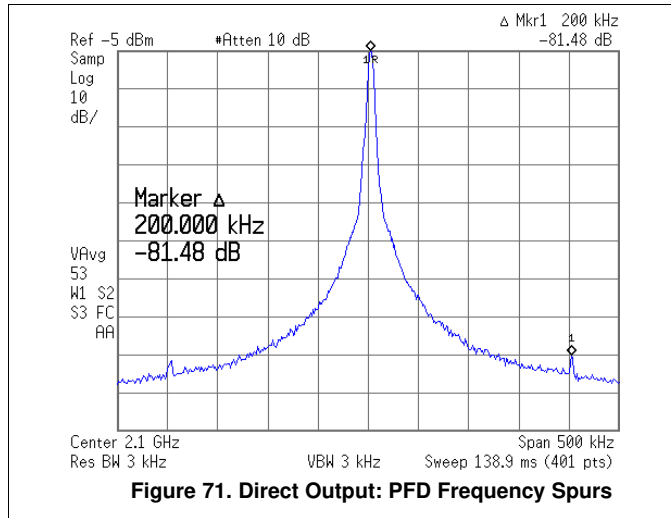

Figure 70. Open Loop VCO Phase Noise

Typical Characteristics, TRF3761-H (See Figure 87) (continued)



7.15.9 Typical Characteristics, TRF3761-J (See Figure 87)

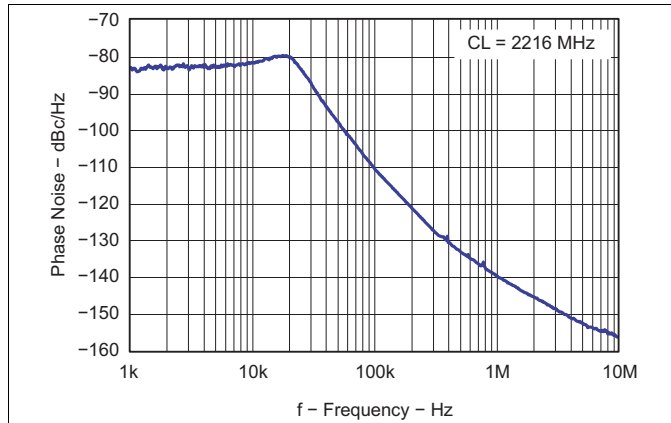

Figure 74. Closed Loop VCO Phase Noise

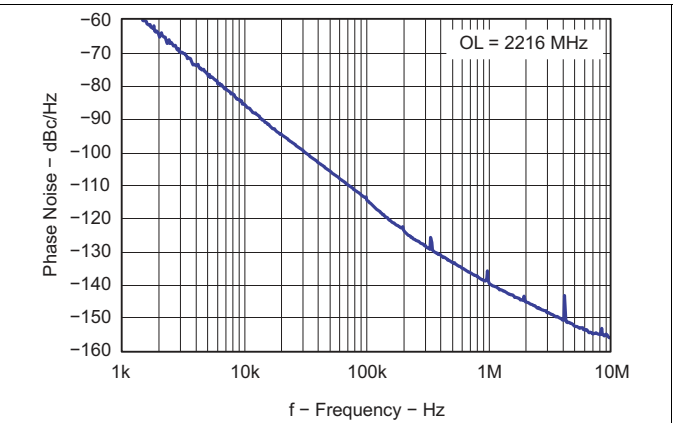

Figure 75. Open Loop VCO Phase Noise

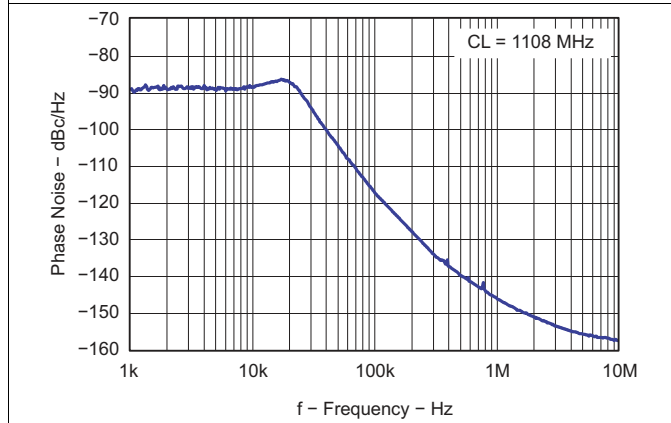

Figure 76. Closed Loop VCO Phase Noise

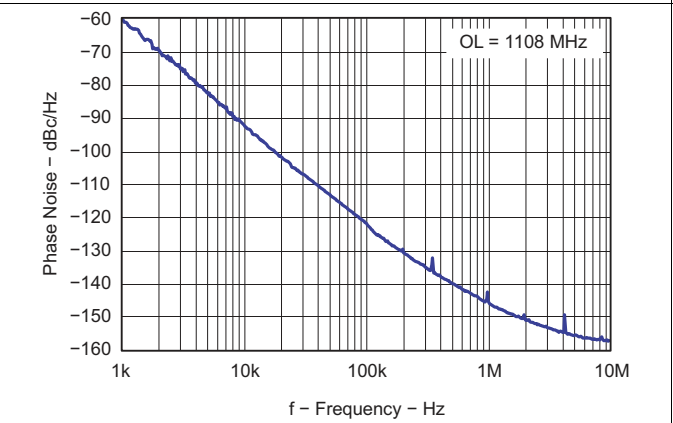

Figure 77. Open Loop VCO Phase Noise

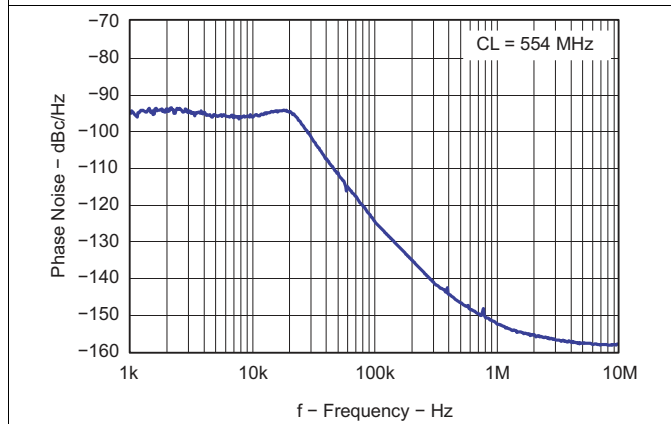

Figure 78. Closed Loop VCO Phase Noise

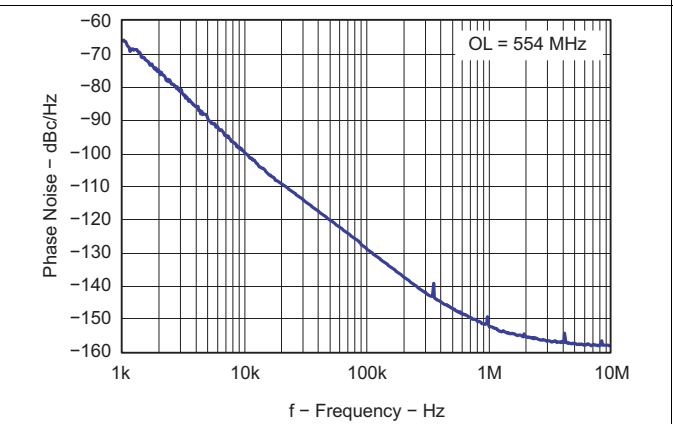

Figure 79. Open Loop VCO Phase Noise

Typical Characteristics, TRF3761-J (See Figure 87) (continued)

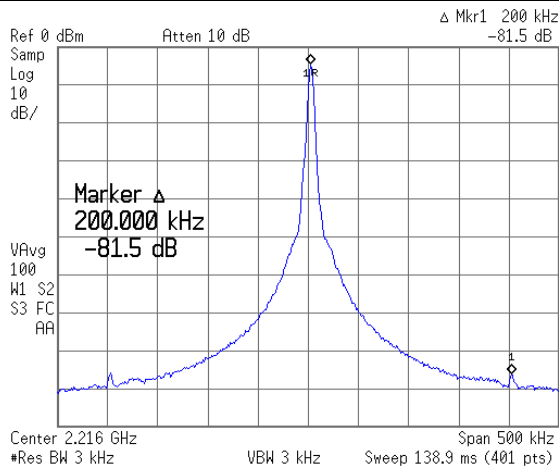

Figure 80. Direct Output: PFD Frequency Spurs

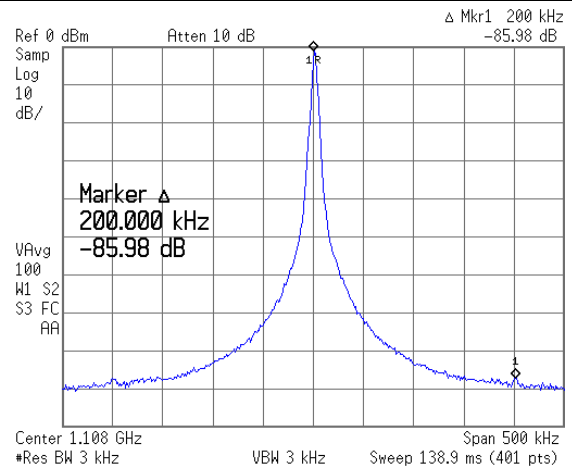

Figure 81. Divide-By-2 Output: PFD Frequency Spurs

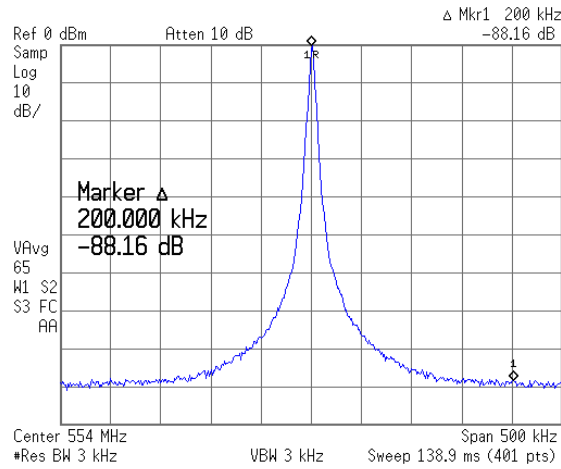

Figure 82. Divide-By-4 Output: PFD Frequency Spurs

8 Detailed Description

8.1 Overview

TRF3761 is an integrated frequency synthesizer with low-noise, voltage-controlled oscillator (VCO) and an integer-N PLL. N-Divider block supports flexible output frequency range. A 3-wire serial-programming interface (SPI) interface is used to control the device. Device also supports power down feature through SPI interface or via chip_en pin.

8.2 Functional Block Diagram

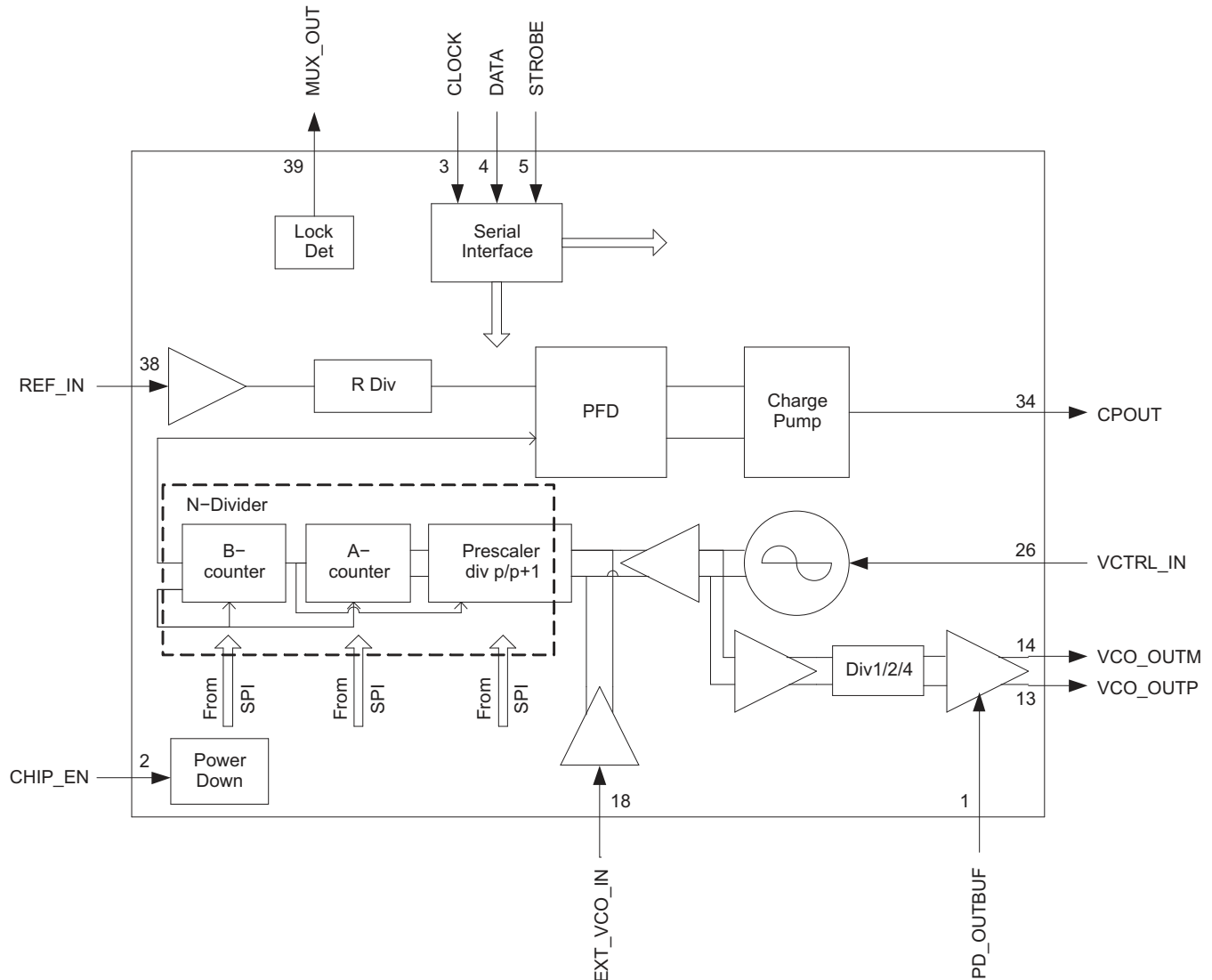

8.3 Feature Description

8.3.1 VCO

The TRF3761 integrates a high-performance, LC tank, voltage-controlled oscillator (VCO). For each of the devices of the TRF3761 family, the inductance and capacitance of the tank are optimized to yield the best phase-noise performance. The VCO output is fed externally and to the prescaler through a series of very low noise buffers, that greatly reduce the effect of load pulling onto the VCO.

Feature Description (continued)

8.3.2 Divide by 2, by 4, and Output Buffer

To extend the frequency coverage, the TRF3761 integrates a divide by 2 and by 4 with a low noise floor. The VCO signal is fed externally through a final open-collector differential-output buffer. This buffer is able to provide up to 3dBm (typical) of power into a 200Ω differential resistive load. The open-collector structure gives the flexibility to choose different load configurations to meet different requirements.

8.3.3 N-Divider

8.3.3.1 Prescaler Stage

This stage divides down the VCO frequency before the A and B counters. This is a dual-modulus prescaler and the user can select any of the following settings: 8/9, 16/17, 32/33, and 64/65. Prescaling is used due to the fact that the internal devices are limited in frequency operations of 200MHz. To determine the proper prescaler value, F_{OUT} which is the frequency out of the VCO is divided by the numerator of the prescaler if the answer is less than 200 MHz then that is the prescaler to use, see [Equation 1](#). If the value is higher than 200 MHz then repeat this procedure with the next prescaler numerator until a value of 200MHz or less is achieved. Refer to [Synthesizing a Selected Frequency](#).

$$\frac{F_{OUT}}{\text{Prescalar}_{num}} \leq 200\text{MHz} \quad (1)$$

8.3.3.2 A and B Counter Stage

The TRF3761 includes a 6-bit A counter and a 13-bit B counter that operate on the output of the prescaler. The A counter can take values from 0 to 63, while the B counter can take values from 3 to 8191. Also, the value for the B counter must be greater than or equal to the value for the A counter. The A and B counter with the prescaler stage create the VCO N-divider, see [Equation 2](#) and [Equation 3](#). Refer to [Synthesizing a Selected Frequency](#).

$$N = \frac{F_{OUT}}{F_{PFD}} = (A_{COUNTER} + \text{Prescalar}_{num} \times B_{COUNTER}) \quad (2)$$

$$\frac{N}{\text{Prescalar}_{num}} = x_{integer} \times y_{decimal} \Rightarrow$$

$$B_{COUNTER} = x_{integer} \text{ and } A_{COUNTER} = \text{Prescalar}_{num} \times y_{decimal} \quad (3)$$

8.3.3.3 Reference Divider

TRF3761 includes a 14-bit RDiv, also known as RDiv, that allows the input reference frequency to be divided down to produce the reference clock to the phase frequency detector (PFD) this clock is also known as F_{PFD} which is also the channel step size. Division ratios from 1 to 16,383 are allowed. To determine RDiv use [Equation 4](#).

$$R_{DIV} = \frac{F_{REF_IN}}{F_{PFD}} \quad (4)$$

The output frequency (F_{out}) is determined using [Equation 5](#).

$$F_{OUT} = F_{PFD} \times N = \frac{F_{REF_IN}}{R_{DIV}} \times (A_{COUNTER} + \text{Prescalar}_{num} \times B_{COUNTER}) \quad (5)$$

8.3.4 Phase Frequency Detector (PFD) and Charge Pump Stage

The outputs of the RDiv and the N counter are fed into the PFD stage, where the two signals are compared in frequency and phase. The TRF3761 features an anti-backlash pulse, whose width is controllable by the user through the serial programming interface. The PFD feeds the charge pump, whose output current pulses are fed into an external loop filter, which eventually produces the tuning voltage needed to control the integrated VCO to the desired frequency.

Feature Description (continued)

8.3.5 Mux Out

MUX_OUT pin (39) provides a communication port to the microcontroller circuit. See [Table 4](#) in the *Detailed Design Procedure* section.

8.3.6 Div 1/2/4

Div 1/2/4 is the frequency divider for the TRF3761. This circuit can be programmed thru the serial programming interface (SPI) to divide the output frequency of the VCO by 1, 2 or 4. This feature allows for the same loop filter design to be used for any of the 3 divide by modes, 1, 2 and 4. For example, if the VCO is running at 1499MHz to 1608MHz band then with the same exact circuit, run the output in the divide by 2 mode 749.5MHz to 804MHz band or in the divide by 4 mode 374.75MHz to 402MHz.

8.3.7 Serial interface

The programming interface pins (3, 4, 5) to the chip are the serial programming interface (SPI). The interface requires a Clock, Data, and Strobe signal to operate. See timing diagram [Figure 83](#).

8.3.8 CHIP ENABLE

This feature provides a way to shut down the chip when not needed in order to conserve power. CHIP_EN Pin (2) needs to be High for normal operation.

8.3.9 Buffer Power Down

PD_OUTBUFF pin (1), when enabled in software can provide a -40dB reduction in the output power while the VCO is locked and running. This feature is to help with isolation between RX and TX.

8.3.10 External VCO IN

EXT_VCO_IN pin (18) allows for the use of an external VCO to use the phase lock loop circuit in the TRF3761. This feature enables higher frequencies to be synthesized.

8.4 Device Functional Modes

8.4.1 Programmable Divider Mode

TRF3761 frequency range is extended by integrating a divide by 2 and by 4 options. The VCO signal is fed externally through differential-output buffer. The divider block allows to divide the output frequency of the VCO by 1, 2 or 4 by programming thru serial programming interface (SPI). These 3 divide by modes of 1, 2 and 4 enables the usage of same loop filter for wider frequency coverage.

8.5 Programming

8.5.1 Serial Interface Programming Registers Definition

The TRF3761 features a 3-wire serial programming interface that controls an internal, 32-bit shift register. There are a total of 3 signals that need to be applied: the CLOCK (pin 3), the serial DATA (pin 4) and the STROBE (pin 5). The DATA (DB0-DB31) is loaded LSB first and is read on the rising edge of the CLOCK. The STROBE is asynchronous to the CLOCK and at its rising edge the data in the shift register gets loaded onto the selected internal register. The first four bits (DB0-DB3) is the address to select the available internal registers.

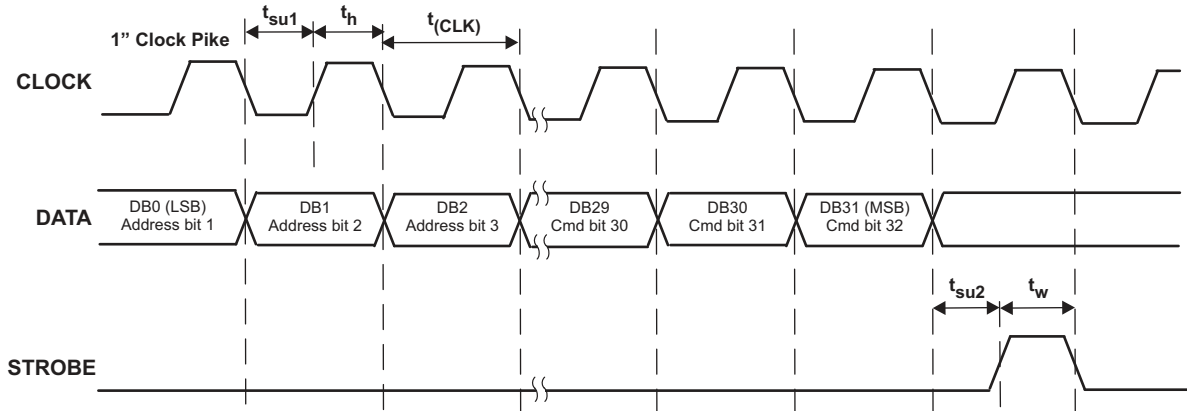

- A. The first 4 bits, DB(3-0), of data are Address bits. The 28 remaining bits, DB(31-4), are part of the command. The command is little endian or lower bits first.

Figure 83. Serial Programming Timing Diagram

8.6 Register Maps

8.6.1 Register 1

Figure 84. Register 1: Device Setup

| DB31 | DB30 | DB29 | DB28 | DB27 | DB26 | DB25 | DB24 | DB23 | DB22 | DB21 | DB20 | DB19 | DB18 | DB17 | DB16 |
|--------------------------------|----------|---------|---------|---------------|---------------|--------------------------------|------|---------------------------------|------|------|------------------|------|------|------|------|
| Full Cal Req | CP_T EST | TRIS_CP | PFD_POL | Anti Backlash | | Reference Clock Divider (RDiv) | | | | | | | | | |
| R/W | R/W | R/W | R/W | R/W | | R/W | | | | | | | | | |
| DB15 | DB14 | DB13 | DB12 | DB11 | DB10 | DB9 | DB8 | DB7 | DB6 | DB5 | DB4 | DB3 | DB2 | DB1 | DB0 |
| Reference Clock Divider (RDiv) | | | | PD BUFO UT | OUTBUF EN_SEL | Output Mode | | Charge Pump Current Select REST | | | Register Address | | | | |
| R/W | | | | R/W | R/W | R/W | | R/W | | | R/W | | | | |

LEGEND: R/W = Read/Write; R = Read only; -n = value after reset

Table 1. Register 1: Device Setup

| REGISTER 1 MAPPING | | | | |
|--------------------|------------|---|---|---|
| Data Field | DB31 | FULL_CAL_REQ | This is a read only bit, that indicates if a power-up cal is required | 0 power-up cal is not required 1 power-up cal is required |
| | DB30 | CP_TEST | T1 internal use only | 1 test enabled |
| | DB29 | TRIS_CP | High-impedance state charge pump output | 1 CP high-impedance state 0 for normal operation |
| | DB28 | PFD_POL | Selects Polarity of PFD, should match polarity of VCO gain. If using external VCO with Negative gain then set to 0 and vise versa. The internal VCO has positive gain so set to positive(1) | 0 negative 1 positive |
| | DB27 | ABPW1 | ABPW<1,0>: anti-backlash pulse width | 00 1.5ns delay 01 0.9ns delay 10 3.8ns delay 11 2.7ns delay |
| | DB26 | ABPW0 | | |
| | DB25 | RDIV_13 | 14-bit reference clock divider | RDIV<13,0>:00...01: divide by 1 RDIV<13,0>:00...10: divide by 2 RDIV<13,0>:00...11: divide by 3 |
| | DB24 | RDIV_12 | | |
| | DB23 | RDIV_11 | | |
| | DB22 | RDIV_10 | | |
| | DB21 | RDIV_9 | | |
| | DB20 | RDIV_8 | | |
| | DB19 | RDIV_7 | | |
| | DB18 | RDIV_6 | | |
| | DB17 | RDIV_5 | | |
| | DB16 | RDIV_4 | | |
| | DB15 | RDIV_3 | | |
| | DB14 | RDIV_2 | | |
| | DB13 | RDIV_1 | | |
| | DB12 | RDIV_0 | | |
| | DB11 | PD_BUFOUT | If DB10 = 0 then it controls power down of output buffer | <DB10:11>: 00 default; output buffer on 01 output buffer off 1x output buffer on/off controlled by OUTBUF_EN pin |
| | DB10 | OUTBUF_EN_SEL | Select Output Buffer enable control: | 0 internal 1 through OUTBUF_EN pin |
| | DB9 | OUT_MODE_1 | OUTBUFMODE<1,0>: Selection of RF output buffer division ratio | 00 divide by 1 01 divide by 2 10 divide by 4 |
| DB8 | OUT_MODE_0 | | | |
| DB7 | ICP2 | ICP<2,0>: select charge pump current (1 mA step). From 1.4mA to 11.2mA with Rbias set to 2.37Kohms. | | |
| DB6 | ICP1 | | | |
| DB5 | ICP0 | | | |
| DB4 | RESET | Registers reset | 1 high 0 low for normal operation | |
| Address Bits | DB3 | | Address Bits <3,0>=0000 for register 1 | |
| | DB2 | | | |
| | DB1 | | | |
| | DB0 | | | |

OUT_MODE<1,0>: TRF3761 has an optional divide by 2 or 4 output, which is selectable by programming bits <OUT_MODE_1, OUT_MODE_0> of register 1 (see [Table 1](#)).

CP_TEST: By setting bit DB30 to 1 it is possible to test the PFD up or down pulses. Internal TI use only.

TRIS_CP: If bit DB29 is set to 1, the charge pump output goes in tri-state. For normal operation, DB29 must be set to 0.

ABPW: Bits <DB27, DB26> are used to program the width of the anti-backlash pulses of the PFD. The user selects one of the following values: 0.9ns, 1.5ns, 2.7ns and 3.8ns. Backlash can occur when F_{pdf} becomes phase aligned with F_{out} of the VCO. This will cause a high impedance state on the phase detector and allow the output frequency to drift until the phase difference is enough to cause the phase detector to start sending signals to the charge pump to correct the difference. This slight variation will show up as a sub harmonic of the pfd signal in the passband of the loop filter which would result in a significant spur in the output of the VCO. It is recommended that the anti-backlash pulse be set to the 1.5ns which gives the best spur reduction for the TRF3761.

PFD_POL: Bit DB28 of register 1 sets the polarity of the PFD. A Low (0) selects a negative polarity, and a High (1) selects a positive polarity. By choosing the correct polarity, the TRF3761 will work with an external VCO having both positive and negative gain (K_v). For example if an external VCO has a K_v = -23MHz/V then the PFD polarity would need to be negative, so DB28 would be set to a Low (0). When using the internal VCO with a K_v of 23MHz/V, the PFD_POL should be set to 1.

RDiv: A 14-bit word programs the RDiv for the reference signal, DB25 is the MSB and DB12 is the LSB. RDiv value is determined by dividing the reference frequency by the channel step size. For example if the reference frequency is 10MHz and the channel step size is 200KHz then RDiv would be 50. This sets up the F_{pdf} for the phase detector, in other words the reference frequency will be divided down by a factor of RDiv which in this example is 50.

ICP: Bits <DB7, DB5> set the charge pump current.

$$I_{CP} = \frac{1.2 \text{ V}}{R_{bias1}} \times (N + 1) \times \frac{22.168}{8} \quad (6)$$

which reduces to:

$$I_{CP} = \frac{3.3252 \times (N + 1)}{R_{bias1}} \quad (7)$$

where N = decimal value of [Reg1 DB<7:5>]. The range is set by N and R_{bias2}. It is recommended that I_{cp} be set to 7mA or <DB7, DB5>=101.

OUTBUF_EN_SEL: Output buffer on/off state is controlled through serial interface or an external pin. If bit DB10 is a 0 (default state) the output buffers state is elected through bit DB11. If DB10 is a 1, the buffers on/off are directly controlled by the OUTBU_EN pin.

RESET: Setting bit DB4 to 1, all registers are reset to default values.

Refer to [Register 1](#) under the [Detailed Design Procedure](#) section.

8.6.2 Register 2

Figure 85. Register 2: VCO Calibration

| | | | | | | | | | | | | | | | |
|---------------------------------------|----------------------|------|------|------|------------------------------------|------|------|------|------|------|------------------|------|------|-------------------------------------|------|
| DB31 | DB30 | DB29 | DB28 | DB27 | DB26 | DB25 | DB24 | DB23 | DB22 | DB21 | DB20 | DB19 | DB18 | DB17 | DB16 |
| STAR T_CAL | VCO Frequency in MHz | | | | | | | | | | | | | Reference Frequency Continued | |
| R/W | | | | R/W | | | | | | | | R/W | | | |
| DB15 | DB14 | DB13 | DB12 | DB11 | DB10 | DB9 | DB8 | DB7 | DB6 | DB5 | DB4 | DB3 | DB2 | DB1 | DB0 |
| Reference Frequency (Fractional Part) | | | | | Reference Frequency (Integer Part) | | | | | | Register Address | | | | |
| R/W | | | | | R/W | | | | | | R/W | | | | |

LEGEND: R/W = Read/Write; R = Read only; -n = value after reset

Table 2. Register 2: VCO Calibration

| REGISTER 2 MAPPING | | | | |
|---------------------|-----------|---|---|---|
| Data Field | DB31 | START_CAL | | 1 start calibration |
| | DB30 | FOUT12 | VCO frequency in MHz start calibration | |
| | DB29 | FOUT11 | | |
| | DB28 | FOUT10 | | |
| | DB27 | FOUT9 | | |
| | DB26 | FOUT8 | | |
| | DB25 | FOUT7 | | |
| | DB24 | FOUT6 | | |
| | DB23 | FOUT5 | | |
| | DB22 | FOUT4 | | |
| | DB21 | FOUT3 | | |
| | DB20 | FOUT2 | | |
| | DB19 | FOUT1 | | |
| | DB18 | FOUT0 | | |
| | DB17 | REF_FRAC6 | Reference frequency in MHz (fractional part) | 0000000 = 0.00MHz 0000001 = 0.01MHz 0000010 = 0.02MHz 1100011 = 0.99MHz |
| | DB16 | REF_FRAC5 | | |
| | DB15 | REF_FRAC4 | | |
| | DB14 | REF_FRAC3 | | |
| | DB13 | REF_FRAC2 | | |
| | DB12 | REF_FRAC1 | | |
| DB11 | REF_FRAC0 | | | |
| DB10 | REF6 | Reference frequency in MHz (integer part) | 0001010 = 10MHz 0001011 = 11MHz 1101000 = 104MHz | |
| DB9 | REF5 | | | |
| DB8 | REF4 | | | |
| DB7 | REF3 | | | |
| DB6 | REF2 | | | |
| DB5 | REF1 | | | |
| DB4 | REF0 | | | |
| Address Bits | DB3 | 0 | Address Bits <3,0>=0001 for register 2 | |
| | DB2 | 0 | | |
| | DB1 | 0 | | |
| | DB0 | 1 | | |

Reference Frequency: The 14 bits <DB17, DB4> are used to specify the input reference frequency as multiples of 10kHz. Bits <DB10, DB4> specify the integer part of the reference frequency expressed in MHz. Bits <DB17, DB11> set the fraction part. Those values are then used during the calibration of the internal VCO. For example if using a 20MHz reference oscillator then bits<DB10, DB4> would be 0010100 and bits<DB17, DB11> would be 0000000. If the reference oscillator is 13.1MHz then bits<DB10, DB4> would be 0001101 and bits<DB17, DB11> would be 0001010.

Start Calibration: A 1 in DB31 starts the internal VCO calibration. When the calibration is complete, DB31 bit is internally reset to 0.

FOUT<12,0>: This 13-bit word <DB30, DB18> specifies the VCO output frequency in MHz. If output frequency is not a integer multiple of MHz, this value must be approximated to the closest integer in MHz.

Refer to [Register 2](#) under the [Detailed Design Procedure](#) section.

8.6.3 Register 3

Figure 86. Register 3: A and B Counters

| | | | | | | | | | | | | | | | |
|-----------|------|----------|----------|-----------|------|------|-----------|-----------------------------|------|------------------|------|------|------|------|------|
| DB31 | DB30 | DB29 | DB28 | DB27 | DB26 | DB25 | DB24 | DB23 | DB22 | DB21 | DB20 | DB19 | DB18 | DB17 | DB16 |
| RSRV | RSRV | Lock PLL | Test MUX | | | | B-Counter | | | | | | | | |
| R/W | R/W | R/W | R/W | | | | R/W | | | | | | | | |
| DB15 | DB14 | DB13 | DB12 | DB11 | DB10 | DB9 | DB8 | DB7 | DB6 | DB5 | DB4 | DB3 | DB2 | DB1 | DB0 |
| B-Counter | | | | A-Counter | | | | Dual-Modulus Prescaler Mode | | Register Address | | | | | |
| R/W | | | | R/W | | | | R/W | | R/W | | | | | |

LEGEND: R/W = Read/Write; R = Read only; -n = value after reset

Table 3. Register 3: A and B Counters

| REGISTER 3 MAPPING | | | | |
|--------------------|------------|-----------------------------|--|----------------------------|
| Data Field | DB31 | Rsrv | Reserved | |
| | DB30 | Rsrv | Reserved | |
| | DB29 | START_LK | Lock PLL to frequency | 1 active |
| | DB28 | TEST_MUX_3 | See Table 4 for descriptions and settings. | 0001 = LOCK_DETECT enabled |
| | DB27 | TEST_MUX_2 | | |
| | DB26 | TEST_MUX_1 | | |
| | DB25 | TEST_MUX_0 | | |
| | DB24 | B_12 | 13-bit B counter | |
| | DB23 | B_11 | | |
| | DB22 | B_10 | | |
| | DB21 | B_9 | | |
| | DB20 | B_8 | | |
| | DB19 | B_7 | | |
| | DB18 | B_6 | | |
| | DB17 | B_5 | | |
| | DB16 | B_4 | | |
| | DB15 | B_3 | | |
| | DB14 | B_2 | 6-bit A counter | |
| | DB13 | B_1 | | |
| | DB12 | B_0 | | |
| DB11 | A_5 | | | |
| DB10 | A_4 | | | |
| DB9 | A_3 | | | |
| DB8 | A_2 | Dual-modulus prescaler mode | <B5,B4>:00 for 8/9 <B5,B4>:01 for 16/17 <B5,B4>:10 for 32/33 <B5,B4>:11 for 64/65 | |
| DB7 | A_1 | | | |
| DB6 | A_0 | Address Bits | <3,0>=0010 for register 3 | |
| DB5 | PRESC_MOD1 | | | |
| DB4 | PRESC_MOD0 | | | |
| Address Bits | DB3 | | | 0 |
| | DB2 | 0 | | |
| | DB1 | 1 | | |
| | DB0 | 0 | | |

B<12,0>: This 13-bit word <DB24,DB12> controls the value of the B counter of the N divider. The valid range is from 3 to 8191.

A<5,0>: These 6 bits <DB11,DB6> control the value of the A counter. The valid range is from 0 to 63.

PRESC_MOD<1,0>: These bits <DB5,DB4> define the mode of the dual-modulus prescaler according to [Table 3](#).

START_LK: TRF3761 does not load the serial interface registers values into the dividers registers until bit DB29 of register 3 is set to 1. After TRF3761 is locked to the new frequency, bit DB29 is internally reset to 0.

Refer to [Register 3](#) under the [Detailed Design Procedure](#) section.

9 Application and Implementation

NOTE

Information in the following applications sections is not part of the TI component specification, and TI does not warrant its accuracy or completeness. TI's customers are responsible for determining suitability of components for their purposes. Customers should validate and test their design implementation to confirm system functionality.

9.1 Application Information

The TRF3761 device is suited for high performance RF transmit signal chain applications such as wireless radio transmitters.

9.1.1 Loop Filter Design

Numerous methodologies and design techniques exist for designing optimized loop filters for particular applications. The loop filter design can affect the stability of the loop, the lock time, the bandwidth, the extra attenuation on the reference spurs, etc. The role of the loop filter is to integrate and lowpass the pulses of the charge pump and eventually yield an output tuning voltage that drives the VCO. Several filter topologies can be implemented, including both passive and active. In this section, a third-order passive filter is used. For this example, assume these several design parameters. The internal VCO has a value of 23MHz/V, meaning that in the linear region, changing the tuning voltage of the VCO by 1V induces a change of the output frequency of about 23MHz. It is known that $N = 4500$ and $F_{pd} = 200\text{kHz}$ from our previous example. It is assumed that current setting in register 1 <DB7:DB5> is set to 100 and sets a maximum current of 5.6mA. TI recommends an I_{cp} of 5.6mA, which give the best spur performance, but can be changed for different application. In addition, the bandwidth of the loop filter must be determined. This is a critical consideration as it affects the lock time of the system. Assuming an approximate bandwidth of around 20kHz is required and that for stability a phase margin of about 45 degrees is desired, the following values for the components of the loop filter can be derived. There is almost an infinite number of solutions to the problem of designing the loop filter and the designer is called to make tradeoff decisions for each application. Texas Instruments has provided a loopfilter program in the product folder for the TRF3761.

Some terms are interchangeable and are described and equated here:

- $F_{com} = F_{PDF}$ which identify the comparing frequency or phase detector frequency which is also equal to the system channel step size. F_{OUT} must be a multiple of F_{com} .
- F_{min} is the lower frequency of the design band.
- F_{max} is the upper frequency of the design band.
- F_{ref} is the reference frequency for the PLL. F_{ref} must be a multiple of F_{com} .
- $K_{vco} = K_v$ expressed in MHz per Volt (MHz/V) which is the gain of the VCO. The TRF3761 internal VCO has a $K_v = 23\text{MHz/V}$.
- I_{cp} is the charge pump current. The TRF3761 is typically set to 5.6mA.
- F_c is the loop filter bandwidth which should be no more than $1/10 F_{com}$.
- ϕ is phase margin in degrees. Values should be between 30 and 70. The higher the phase margin the better the stability of the PLL but the slower the lock time. 45 degrees is a good tradeoff.
- T3/T1 in percent is the percentage of the poles in the loop filter. Usually set to 45%. The higher the value (closer to 100%) the more the spurs are attenuated, but peaking occurs in the pass band of the loop filter.

$$F_{OUT} = \sqrt{F_{min}F_{max}} \quad (8)$$

$$N = \frac{F_{OUT}}{F_{com}} \quad (9)$$

$$\omega_c = 2\pi F_c \quad (10)$$

Application Information (continued)

$$T1 = \frac{\left(\frac{1}{\cos\phi}\right) - \tan\phi}{\omega_c \left(1 + \frac{T3}{T1}\right)} \quad (11)$$

$$T3 = \left(\frac{T3}{T1}\right) T1 \quad (12)$$

$$T2 = \frac{1}{\omega_c^2 (T1 + T3)} \quad (13)$$

$$C1 = \frac{T1}{T2} \times \frac{K_{VCO} K_\phi}{\omega_c^2 N} \times \left[\frac{1 + (\omega_c T2)^2}{\left(1 + \omega_c^2 T1^2\right) \left(1 + \omega_c^2 T3^2\right)} \right]^{\frac{1}{2}} \quad (14)$$

$$C2 = C1 \left(\frac{T2}{T1} - 1\right), \quad C3 = \frac{C1}{10} \quad (15)$$

$$R1 = \frac{T2}{C2}, \quad R2 = \frac{T3}{C3} \quad (16)$$

9.2 Typical Applications

Figure 87 shows a typical application schematic for the TRF3761. In this example, the output signal is taken differential using the 2 resistive pull-up resistors of the final output buffer. A single-ended and tuned load configuration is also available.

The loop filter components:

$C1 = 303\text{pF}$, $R1 = 8.87\text{k}\Omega$, $C2 = 1650\text{pF}$, $R2 = 3.4\text{k}\Omega$, $C3 = 330\text{pF}$ are the typical values used for the Figure 87. The values can be optimized differently according to the requirements of the different applications.

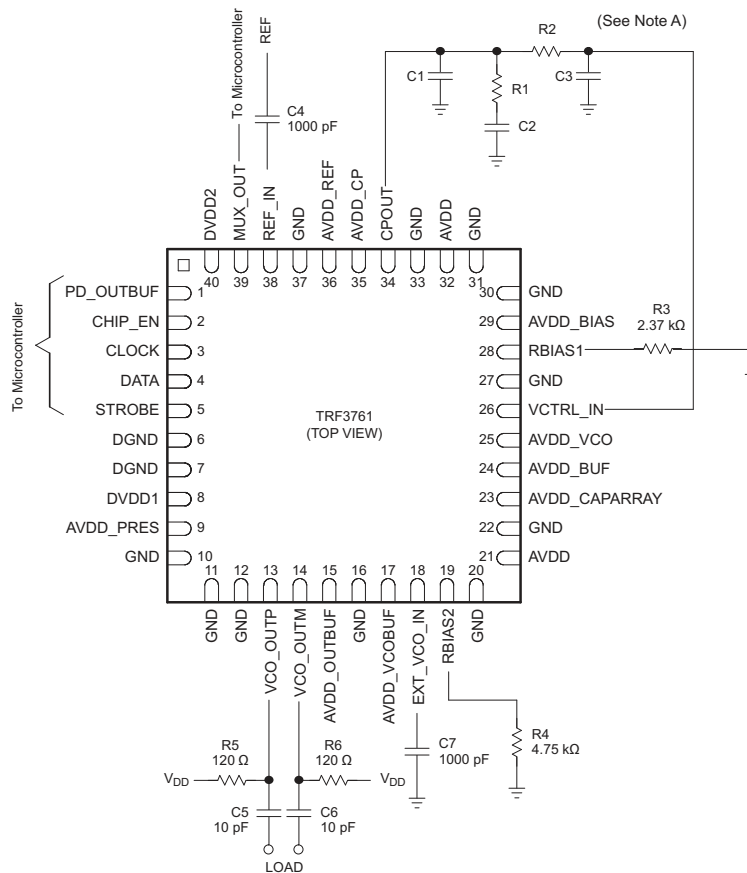

A. Refer to the [Loop Filter Design](#) section.

Figure 87. TRF3761 Application Schematic

9.2.1 Design Requirements

9.2.1.1 Loop Filter Design Example

Given these parameters which were used for the lock time plot in Figure 88:

- $F_{\min} = 2085 \text{ MHz}$
- $F_{\max} = 2175 \text{ MHz}$
- $F_{\text{com}} = 400 \text{ KHz}$
- $I_{\text{cp}} = 4.2\text{mA}$
- $K_{\text{vco}} = 23 \text{ MHz}$
- $F_c = 20 \text{ KHz}$
- Phase Margin = 45 degrees
- $T3/T1 = 45\%$

Typical Applications (continued)

Calculate F_{OUT} of design

$$F_{OUT} = \sqrt{F_{min}F_{max}} = 2130\text{MHz (rounded up)} \quad (17)$$

Next calculate N

$$N = \frac{F_{OUT}}{F_{com}} = 5325 \quad (18)$$

Then calculate ω_c

$$\omega_c = 2\pi F_c = 125.66 \times 10^3 \quad (19)$$

Now calculate T1-T3 to give the RC time constants.

$$T_1 = \frac{\left(\frac{1}{\cos\phi}\right) - \tan\phi}{\omega_c \left(1 + \frac{T_3}{T_1}\right)} = 2.3 \times 10^{-6} \quad (20)$$

Use T1 to find T3

$$T_3 = \left(\frac{T_3}{T_1}\right)T_1 = 1 \times 10^{-6} \quad (21)$$

Then use T1 and T3 to find T2

$$T_2 = \frac{1}{\omega_c^2 (T_1 + T_3)} = 19.2 \times 10^{-6} \quad (22)$$

Now C1, C2, C3, R1, and R2 are calculated using T1, T2, and T3.

$$C_1 = \frac{T_1}{T_2} \times \frac{K_{VCO}K\phi}{\omega_c^2 N} \times \left[\frac{1 + (\omega_c T_2)^2}{\left(1 + \omega_c^2 T_1^2\right) \left(1 + \omega_c^2 T_3^2\right)} \right]^{\frac{1}{2}} = 338.75\text{pF} \quad (23)$$

$$C_2 = C_1 \left(\frac{T_2}{T_1} - 1 \right) = 2524.14\text{pF} \quad (24)$$

$$C_3 = \frac{C_1}{10} = 33.87\text{pF} \quad (25)$$

Now using C2 and T2, find R2. Use C3 and T3 to find R3

$$R_2 = \frac{T_2}{C_2} = 7.61\text{k}\Omega \quad (26)$$

$$R_3 = \frac{T_3}{C_3} = 30.2\text{k}\Omega \quad (27)$$

$R_2 \times C_3$ can be scaled using T3, so if $C_3 = 330\text{pF}$, then $R_2 = 3.03 \text{ k}\Omega \Rightarrow 3.4 \text{ k}\Omega$ in the loop filter. $R_1 \times C_2$ can be scaled using T2. Scaling these values helps to improve the lock time. The actual values used in the lock time plot were optimized for lock time as well as using real valued components. The values in figure 62 were taken from the current EVM schematic.

Typical Applications (continued)

9.2.2 Detailed Design Procedure

9.2.2.1 Initial Calibration and Frequency Setup at Power Up

The integrated high performance VCO requires an internal frequency calibration at power up. To perform such calibration the following procedure is recommended:

- Apply 5V power supply to IC.
- Apply an input reference frequency to pin (38) and ensure the signal is stable.
- Turn on the TRF3761 using the chip enable pin (CHIP_EN, pin 2), by applying 5V.

9.2.2.1.1 Register 1

- Setup the device through Register 1 referencing [Table 1](#).
 - a. The first 4 bits of the 32-bit code sent to the chip are set DB <3:0> to 0000; which is the address of register 1.
 - b. Bit 5, DB4, sets the soft reset for the chip. Soft reset allows for the registers to be reset without powering down the chip. If a soft reset is used then write to register 1 twice: once with DB4 set high and once with DB4 set low. Typically, this bit is only used when the chip has been powered up and registers 1, 2, and 3 have already been written to, so on power-up reset is not required, so DB4 is, by default, set low.
 - c. DB <7: 5> sets the charge pump current based on the resistor value on pin 28 of the TRF3761 and the decimal value of Register 1, DB<7:5> used in [Equation 6](#). This equation reduces to [Equation 7](#), where $N = \text{decimal value of [Reg1 DB<7:5>]}$.
 - d. DB <9: 8> sets the mode of the chip. The mode is how the device will or will not divide down the VCO's frequency. There are 3 choices for the mode setting, divide by 1, 2 or 4 per [Table 1](#). For example, if 393.75MHz is required from the TRF3761 which has a main frequency of 1575MHz then the divide-by-4 mode is chosen by setting DB <9: 8> to 10.
 - e. DB <11:10> controls the output buffer. Both of these are set to 00 by default, so the buffer is controlled internally. Refer to [Table 1](#) for more information.
 - f. DB <25:12> sets the RDiv value. Once the calculations under the [Synthesizing a Selected Frequency](#) section have been completed the value is known, based on the external reference oscillator. The value for R is entered into the DB <25:12>. For example, if the reference oscillator is at a frequency ($F_{\text{REF_IN}}$) of 61.44MHz and a channel step size of 120kHz is required, which is also the frequency (F_{PFD}) the phase frequency detector will use to compare against the VCO's output frequency (F_{OUT}), then $F_{\text{REF_IN}} / F_{\text{PFD}} = 512$, which is entered as follows: MSB: LSB 000100000000.
 - g. By default, DB <27:26> are set to 00 for a 1.5ns delay on the anti-backlash pulse width. Refer to [Table 1](#) for more information.
 - h. DB 28 is set to 1 for positive by default. Refer to [Table 1](#) for more information.
 - i. DB 29 is set to 0 for normal operation. Refer to [Table 1](#) for more information.
 - j. DB 30 is set to 0 by default. Refer to [Table 1](#) for more information.
 - k. DB 31 is set to 0 by default. Refer to [Table 1](#) for more information.

Typical Applications (continued)

9.2.2.1.2 Register 2

- Initiate calibration procedure by programming register 2 as follows: Reference [Table 2](#).
 - a. The first 4 bits of the 32-bit code sent to the chip are set DB <3:0> to 0001; which is the address of register 2.
 - b. Use bits DB<17, 4> of register 2 to specify the input reference frequency in MHz. The value is split into an integer and a fraction part. For example: to insert a f_{REF} of 30.72MHz, set:
 - DB<10, 4> (integer part) equal to 0011110 (30) and
 - DB<17, 11> (fraction part) equal to 1001000 (72).
 - c. Set DB<30:18> of register 2 to the desired frequency. For example: 2200MHz would be 0100010011000 (2200).
 - d. Set DB31 of register 2 to 1 to start the calibration. The VCO calibration runs for 5ms. During the cal procedure it will not be possible to program register 2 and 3. At the end of the calibration, bit DB31 of register 2 resets to 0.
 - e. Subsequent frequency programming requires DB31 to be set to 0.

9.2.2.1.3 Register 3

- Completion of the frequency set up, on initial calibration, cannot proceed until 5ms has elapsed, due to full calibration, then it will require that the A and B values, the prescalar ratio, be known. Refer to [Synthesizing a Selected Frequency](#) section for calculation. Reference [Table 3](#).
 - a. The first 4 bits of the 32-bit code sent to the chip are set DB <3:0> to 0010; which is the address of register 3.
 - b. DB<5:4> sets the prescalar ratio, 8/9, 16/17, 32/33, 64/65. For example: if 16/17 are required, set the register bits DB<5:4> to 01.
 - c. DB<11:6> sets the A value for the N counter. For example: if A is 4, set DB<11:6> as follows: 000100 (4).
 - d. DB<24:12> sets the B value for the N counter. For example: if B is 1156, set DB<24:12> as follows: 0010010000100 (4).
 - e. DB<28:25> sets the TEST_MUX. This allows the user to check via the microcontroller the state of the TRF3761 by programming it to one of 6 states. The most common state to use is the Digital lock Detect which places the pin in a logic high state with indicates the VCO is locked.

Table 4. MUX-Out Settings

| STATE | DB<28:25> | STATE | DB<28:25> |
|--|-----------|---|-----------|
| 3-state o/p (High impedance state on Pin 39) | 0000 | RDiv o/p (Shows R-value on Pin 39) | 0100 |
| Digital lock Detect (High when locked on Pin 39) | 0001 | Analog lock detect (High when locked on Pin 39) | 0101 |
| N-Divider o/p (Shows N-value on Pin 39) | 0010 | Read back (read back register settings) | 0110 |
| DVDD (internal TI use) | 0011 | DGND (internal TI use) | 0111 |

- f. DB29 sets the START LOCK, which is set to 0, on the initial frequency setup and then set to 1 on additional frequency changes.

Once all registers are written, the TRF3761 will lock to the desired frequency. In order to change the frequency once the initial calibration is complete, only registers 2 and 3 need to be reprogrammed. No calibration is required.

9.2.2.2 Re-Calibration After Power Up

Assuming the TRF3761 is powered up and operational, a VCO calibration is also possible without powering down the IC. To perform such calibration the following procedure is recommended:

- Set bit DB4 (RESET) of register 1 to 1. This performs a software reset and clears all registers of VCO calibration data. Once the reset command is issued then DB4 of register 1 will need to be set to 0.
- Repeat the [Initial Calibration and Frequency Setup at Power Up](#) section, skipping the power up section and performing the register programming sequence.

9.2.2.3 Synthesizing a Selected Frequency

The TRF3761 is an integer-N PLL synthesizer, and because of its flexibility (14-bit RDiv, 6-bit A counter, 13-bit B counter, and dual modulus prescaler), is ideal for synthesizing virtually any desired frequency. If synthesizing a 900MHz local oscillator, with spacing capability (minimum frequency increment) of 200kHz, as in a typical GSM application, the choice of the external reference oscillator is beyond the scope of this section. However, if a 10MHz reference is selected, the settings are calculated to yield the desired output frequency and channel spacing. There is more than one solution to a specific set of conditions, so below is one way of achieving the desired result. First, select the appropriate RDiv counter value. Since a channel spacing of 200kHz is desired, the F_{PFD} is set to 200kHz. Calculate the RDiv value through:

$$RDiv = F_{REFIN}/F_{PFD} = 10MHz / 200kHz = 50 \quad (28)$$

Assume a prescaler value of 8/9 is selected. This is a valid choice, since the prescaler output is well within the 200MHz limit ($900MHz / 8 = 112.5MHz$). Select the appropriate A and B counter values.

$$RFOUT = F_{PFD} \times N = (F_{REFIN} / RDiv) \times (A \text{ counter} + \text{Prescaler numerator} \times B \text{ counter}). \quad (29)$$

Therefore, [Equation 30](#) must be solved:

$$900MHz = 200kHz \times (A + 8 \times B). \quad (30)$$

There are many solutions to this single equation with two unknowns; there are some basic constraints on the solution, since $3 \leq B \leq 8191$, and also $B \geq A$. So, if $A = 4$, solving the equation yields $B = 562$. One complete solution would be to choose:

$$RDiv = 50, A \text{ counter} = 4, B \text{ counter} = 562 \text{ and Prescaler} = 8/9$$

resulting in the desired N counter value = 4500. This is how the A counter, B counter and prescaler make up the N counter.

When this procedure is complete the values for the N counter, R, and the prescaler ratio should be known. Registers 2 and 3 need to be set up for operation of the chip. Refer to [Table 2](#) and [Table 3](#) for this procedure. Register 2 bits <DB30:DB18> 12:0 set the output frequency of the device along with register 3. Refer to [N-Divider](#) section under the [Feature Description](#).

9.2.3 Application Curve

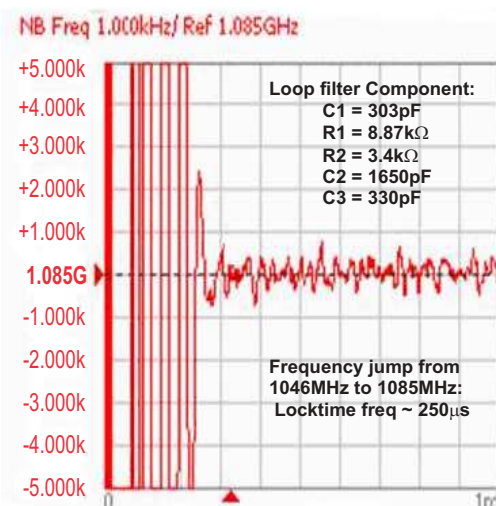

Figure 88. Frequency Locktime

9.2.4 Application Example for a High Performance RF Transmit Signal Chain

Much in the same way as described above, the TRF3761 is an ideal synthesizer to use in implementing a complete high performance RF transmitter chain such as the TSW3000 and TSW3003 Demonstration kits. Using a complete suite of high performance Texas Instruments components, a state-of-the-art transmitter can be implemented featuring excellent performance. Texas Instruments offers ideal solutions for the digital-to-analog conversion portion of transmitter as well as the analog and RF components needed to complete the transmitter. The baseband digital data is converted to I and Q signals through the dual DAC5687, which features a 16-bit interpolating dual digital-to-analog converter (DAC). The device incorporates a digital modulator, independent differential offset control, and I/Q amplitude control. The device is typically used in baseband mode or in low IF mode in conjunction with an analog quadrature modulator. The DAC5687, after filtering, feeds a TRF3703, which is a direct, upconversion IQ modulator. This device accepts a differential input voltage quadrature signal at baseband or low IF frequencies and outputs a modulated RF signal based on the LO drive frequency. The LO drive input of the IQ modulator is generated by the TRF3761. The TRF3761 is a family of high performance, highly integrated frequency synthesizers, optimized for wireless infrastructure applications. The TRF3761 includes an integrated VCO and integer-N PLL. Different members of the TRF3761 family can be chosen for application specific VCO frequency ranges. In addition, the CDC7005 clocking solution can be used to clock the DAC and other portions of the transmitter. A block diagram of the proposed architecture is shown in Figure 89 and Figure 90. For more details, contact Texas Instruments directly.

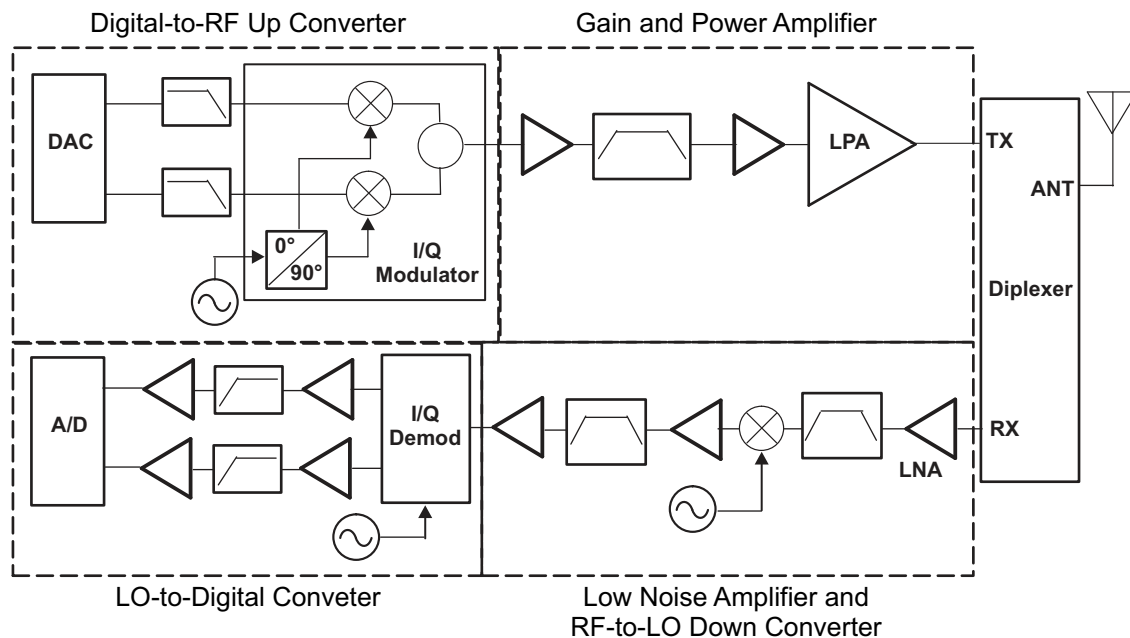

Figure 89. Transmit Chain Block Diagram

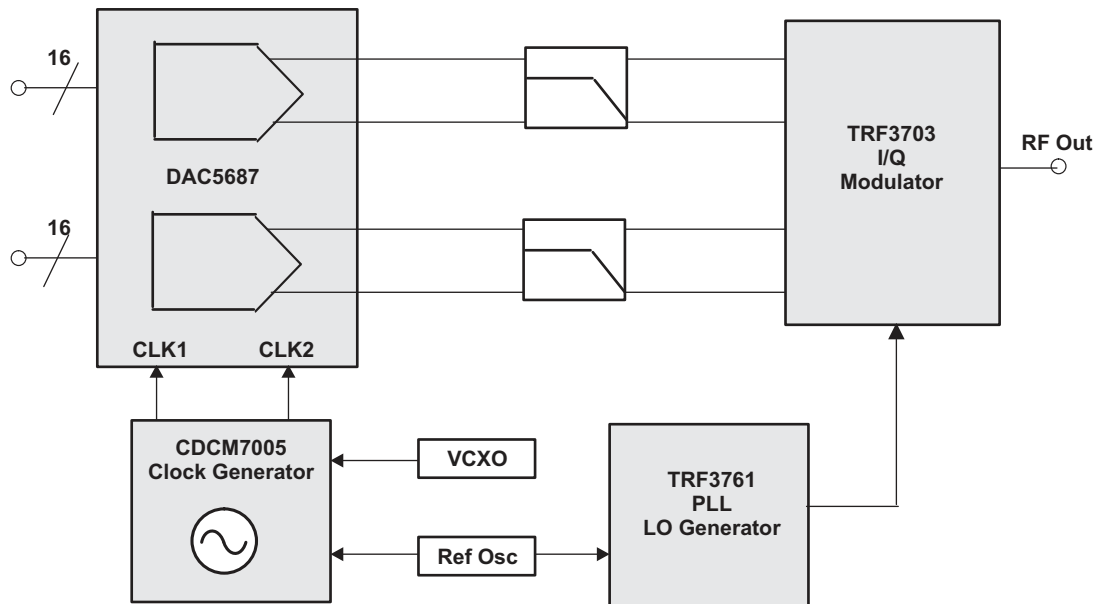

Figure 90. Transmit Chain Block Diagram

10 Power Supply Recommendations

TRF3761 should be supplied with a low noise 4.5-V to 5.25-V supply as required. Each supply pin should generally be isolated from the main power bus with a ferrite or other noise filtering component.

11 Layout

11.1 Layout Guidelines

When designing the complete PLL, this section is of paramount importance in achieving the desired performance. Wherever possible, a multi-layer PCB board should be used, with at least one dedicated ground plane. A dedicated power plane (split between the supplies if necessary) is also recommended. The impedance of all RF traces (the VCO output and feedback into the PLL) should be controlled to 50Ω. All small value (10pF and 0.1μF) decoupling capacitors should be placed as close to the device pins as possible. It is also recommended that both top and bottom layers of the circuit board be flooded with ground, with plenty of ground vias dispersed as appropriate. Because the digital lines are not in use during normal operation of the device and are only used to program the device on start up and during frequency changes the analog grounds (GND) and digital grounds (DGND) are tied to the same ground plane. The most sensitive part of any PLL is the section between the charge pump output and the input to the VCO. This includes the loop filter components, and the corresponding traces. The charge pump is a precision element of the PLL and any extra leakage on its path can adversely affect performance. Extra care should be given to ensure that parasitics are minimized in the charge pump output, and that the trace runs are short and optimized. Similarly, it is also recommend that extra care is taken in ensuring that any flux residue is thoroughly cleaned and moisture baked out of the PCB. From an EMI perspective, and since the synthesizer is typically a small portion of a bigger, complex circuit board, shielding is recommended to minimize EMI effects.

11.2 Layout Example

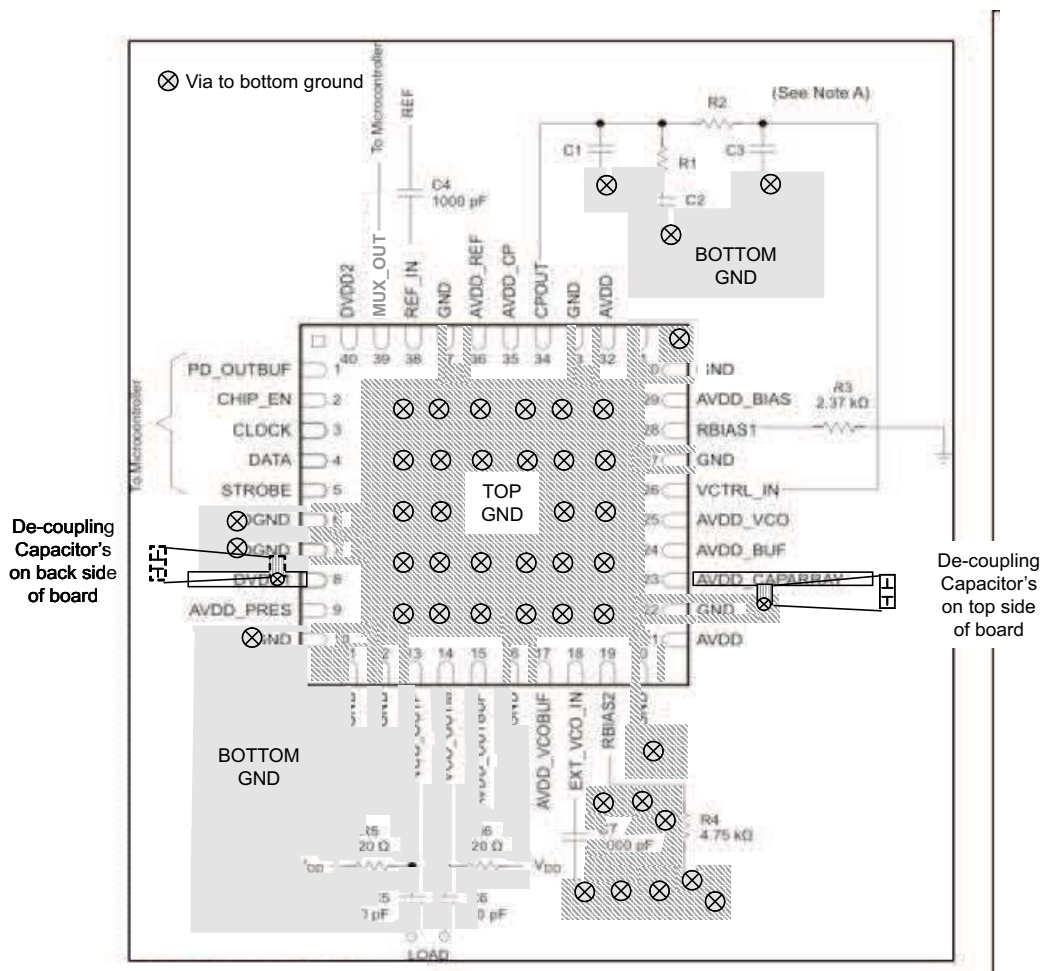

A. Refer to the [Loop Filter Design](#) section.

Figure 91. TRF3761 Layout

12 Device and Documentation Support

12.1 Related Links

The table below lists quick access links. Categories include technical documents, support and community resources, tools and software, and quick access to sample or buy.

Table 5. Related Links

| PARTS | PRODUCT FOLDER | SAMPLE & BUY | TECHNICAL DOCUMENTS | TOOLS & SOFTWARE | SUPPORT & COMMUNITY |
|-----------|----------------------------|----------------------------|----------------------------|----------------------------|----------------------------|
| TRF3761 | Click here | Click here | Click here | Click here | Click here |
| TRF3761-A | Click here | Click here | Click here | Click here | Click here |
| TRF3761-B | Click here | Click here | Click here | Click here | Click here |
| TRF3761-C | Click here | Click here | Click here | Click here | Click here |
| TRF3761-D | Click here | Click here | Click here | Click here | Click here |
| TRF3761-E | Click here | Click here | Click here | Click here | Click here |
| TRF3761-F | Click here | Click here | Click here | Click here | Click here |
| TRF3761-G | Click here | Click here | Click here | Click here | Click here |
| TRF3761-H | Click here | Click here | Click here | Click here | Click here |
| TRF3761-J | Click here | Click here | Click here | Click here | Click here |
| TRF3761-K | Click here | Click here | Click here | Click here | Click here |

12.2 Community Resources

The following links connect to TI community resources. Linked contents are provided "AS IS" by the respective contributors. They do not constitute TI specifications and do not necessarily reflect TI's views; see TI's [Terms of Use](#).

TI E2E™ Online Community *TI's Engineer-to-Engineer (E2E) Community*. Created to foster collaboration among engineers. At e2e.ti.com, you can ask questions, share knowledge, explore ideas and help solve problems with fellow engineers.

Design Support *TI's Design Support* Quickly find helpful E2E forums along with design support tools and contact information for technical support.

12.3 Trademarks

E2E is a trademark of Texas Instruments.
 All other trademarks are the property of their respective owners.

12.4 Electrostatic Discharge Caution



These devices have limited built-in ESD protection. The leads should be shorted together or the device placed in conductive foam during storage or handling to prevent electrostatic damage to the MOS gates.

12.5 Glossary

SLYZ022 — *TI Glossary*.

This glossary lists and explains terms, acronyms, and definitions.

13 Mechanical, Packaging, and Orderable Information

The following pages include mechanical, packaging, and orderable information. This information is the most current data available for the designated devices. This data is subject to change without notice and revision of this document. For browser-based versions of this data sheet, refer to the left-hand navigation.

PACKAGING INFORMATION

| Orderable Device | Status (1) | Package Type | Package Drawing | Pins | Package Qty | Eco Plan (2) | Lead finish/ Ball material (6) | MSL Peak Temp (3) | Op Temp (°C) | Device Marking (4/5) | Samples |
|------------------|---------------|--------------|-----------------|------|-------------|-----------------|--------------------------------------|----------------------|--------------|-------------------------|-------------------------|
| TRF3761-AIRHAR | ACTIVE | VQFN | RHA | 40 | 2500 | RoHS & Green | NIPDAUAG | Level-3-260C-168 HR | -40 to 85 | TRF3761 -A | Samples |
| TRF3761-AIRHAT | ACTIVE | VQFN | RHA | 40 | 250 | RoHS & Green | NIPDAUAG | Level-3-260C-168 HR | -40 to 85 | TRF3761 -A | Samples |
| TRF3761-BIRHAT | ACTIVE | VQFN | RHA | 40 | 250 | RoHS & Green | NIPDAUAG | Level-3-260C-168 HR | -40 to 85 | TRF3761 -B | Samples |
| TRF3761-CIRHAT | ACTIVE | VQFN | RHA | 40 | 250 | RoHS & Green | NIPDAUAG | Level-3-260C-168 HR | -40 to 85 | TRF3761 -C | Samples |
| TRF3761-EIRHAR | ACTIVE | VQFN | RHA | 40 | 2500 | RoHS & Green | NIPDAUAG | Level-3-260C-168 HR | -40 to 85 | TRF3761 -E | Samples |
| TRF3761-EIRHAT | ACTIVE | VQFN | RHA | 40 | 250 | RoHS & Green | NIPDAUAG | Level-3-260C-168 HR | -40 to 85 | TRF3761 -E | Samples |
| TRF3761-FIRHAT | ACTIVE | VQFN | RHA | 40 | 250 | RoHS & Green | NIPDAUAG | Level-3-260C-168 HR | -40 to 85 | TRF3761 -F | Samples |
| TRF3761-GIRHAT | ACTIVE | VQFN | RHA | 40 | 250 | RoHS & Green | NIPDAUAG | Level-3-260C-168 HR | -40 to 85 | TRF3761 -G | Samples |
| TRF3761-HIRHAT | ACTIVE | VQFN | RHA | 40 | 250 | RoHS & Green | NIPDAUAG | Level-3-260C-168 HR | -40 to 85 | TRF3761 -H | Samples |
| TRF3761-JIRHAT | ACTIVE | VQFN | RHA | 40 | 250 | RoHS & Green | NIPDAUAG | Level-3-260C-168 HR | -40 to 85 | TRF3761 -J | Samples |

(1) The marketing status values are defined as follows:

ACTIVE: Product device recommended for new designs.

LIFEBUY: TI has announced that the device will be discontinued, and a lifetime-buy period is in effect.

NRND: Not recommended for new designs. Device is in production to support existing customers, but TI does not recommend using this part in a new design.

PREVIEW: Device has been announced but is not in production. Samples may or may not be available.

OBSOLETE: TI has discontinued the production of the device.

(2) **RoHS:** TI defines "RoHS" to mean semiconductor products that are compliant with the current EU RoHS requirements for all 10 RoHS substances, including the requirement that RoHS substance do not exceed 0.1% by weight in homogeneous materials. Where designed to be soldered at high temperatures, "RoHS" products are suitable for use in specified lead-free processes. TI may reference these types of products as "Pb-Free".

RoHS Exempt: TI defines "RoHS Exempt" to mean products that contain lead but are compliant with EU RoHS pursuant to a specific EU RoHS exemption.

Green: TI defines "Green" to mean the content of Chlorine (Cl) and Bromine (Br) based flame retardants meet JS709B low halogen requirements of <=1000ppm threshold. Antimony trioxide based flame retardants must also meet the <=1000ppm threshold requirement.

- (3) MSL, Peak Temp. - The Moisture Sensitivity Level rating according to the JEDEC industry standard classifications, and peak solder temperature.
- (4) There may be additional marking, which relates to the logo, the lot trace code information, or the environmental category on the device.
- (5) Multiple Device Markings will be inside parentheses. Only one Device Marking contained in parentheses and separated by a "~" will appear on a device. If a line is indented then it is a continuation of the previous line and the two combined represent the entire Device Marking for that device.
- (6) Lead finish/Ball material - Orderable Devices may have multiple material finish options. Finish options are separated by a vertical ruled line. Lead finish/Ball material values may wrap to two lines if the finish value exceeds the maximum column width.

Important Information and Disclaimer:The information provided on this page represents TI's knowledge and belief as of the date that it is provided. TI bases its knowledge and belief on information provided by third parties, and makes no representation or warranty as to the accuracy of such information. Efforts are underway to better integrate information from third parties. TI has taken and continues to take reasonable steps to provide representative and accurate information but may not have conducted destructive testing or chemical analysis on incoming materials and chemicals. TI and TI suppliers consider certain information to be proprietary, and thus CAS numbers and other limited information may not be available for release.

In no event shall TI's liability arising out of such information exceed the total purchase price of the TI part(s) at issue in this document sold by TI to Customer on an annual basis.

TAPE AND REEL INFORMATION

QUADRANT ASSIGNMENTS FOR PIN 1 ORIENTATION IN TAPE

*All dimensions are nominal

| Device | Package Type | Package Drawing | Pins | SPQ | Reel Diameter (mm) | Reel Width W1 (mm) | A0 (mm) | B0 (mm) | K0 (mm) | P1 (mm) | W (mm) | Pin1 Quadrant |
|----------------|--------------|-----------------|------|------|--------------------|--------------------|---------|---------|---------|---------|--------|---------------|
| TRF3761-AIRHAR | VQFN | RHA | 40 | 2500 | 330.0 | 16.4 | 6.3 | 6.3 | 1.5 | 12.0 | 16.0 | Q2 |
| TRF3761-EIRHAR | VQFN | RHA | 40 | 2500 | 330.0 | 16.4 | 6.3 | 6.3 | 1.5 | 12.0 | 16.0 | Q2 |

TAPE AND REEL BOX DIMENSIONS

*All dimensions are nominal

| Device | Package Type | Package Drawing | Pins | SPQ | Length (mm) | Width (mm) | Height (mm) |
|----------------|--------------|-----------------|------|------|-------------|------------|-------------|
| TRF3761-AIRHAR | VQFN | RHA | 40 | 2500 | 350.0 | 350.0 | 43.0 |
| TRF3761-EIRHAR | VQFN | RHA | 40 | 2500 | 350.0 | 350.0 | 43.0 |

GENERIC PACKAGE VIEW

RHA 40

VQFN - 1 mm max height

6 x 6, 0.5 mm pitch

PLASTIC QUAD FLATPACK - NO LEAD

This image is a representation of the package family, actual package may vary.
Refer to the product data sheet for package details.

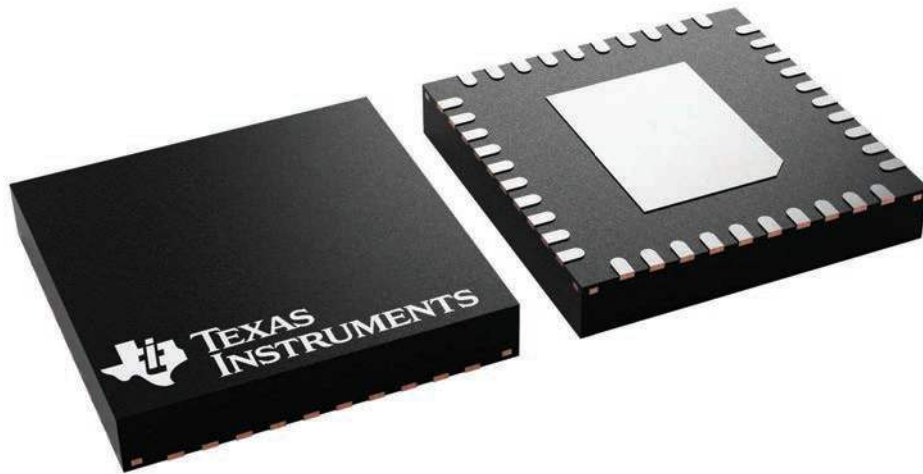

RHA0040H

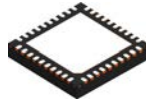

PACKAGE OUTLINE

VQFN - 1 mm max height

PLASTIC QUAD FLATPACK - NO LEAD

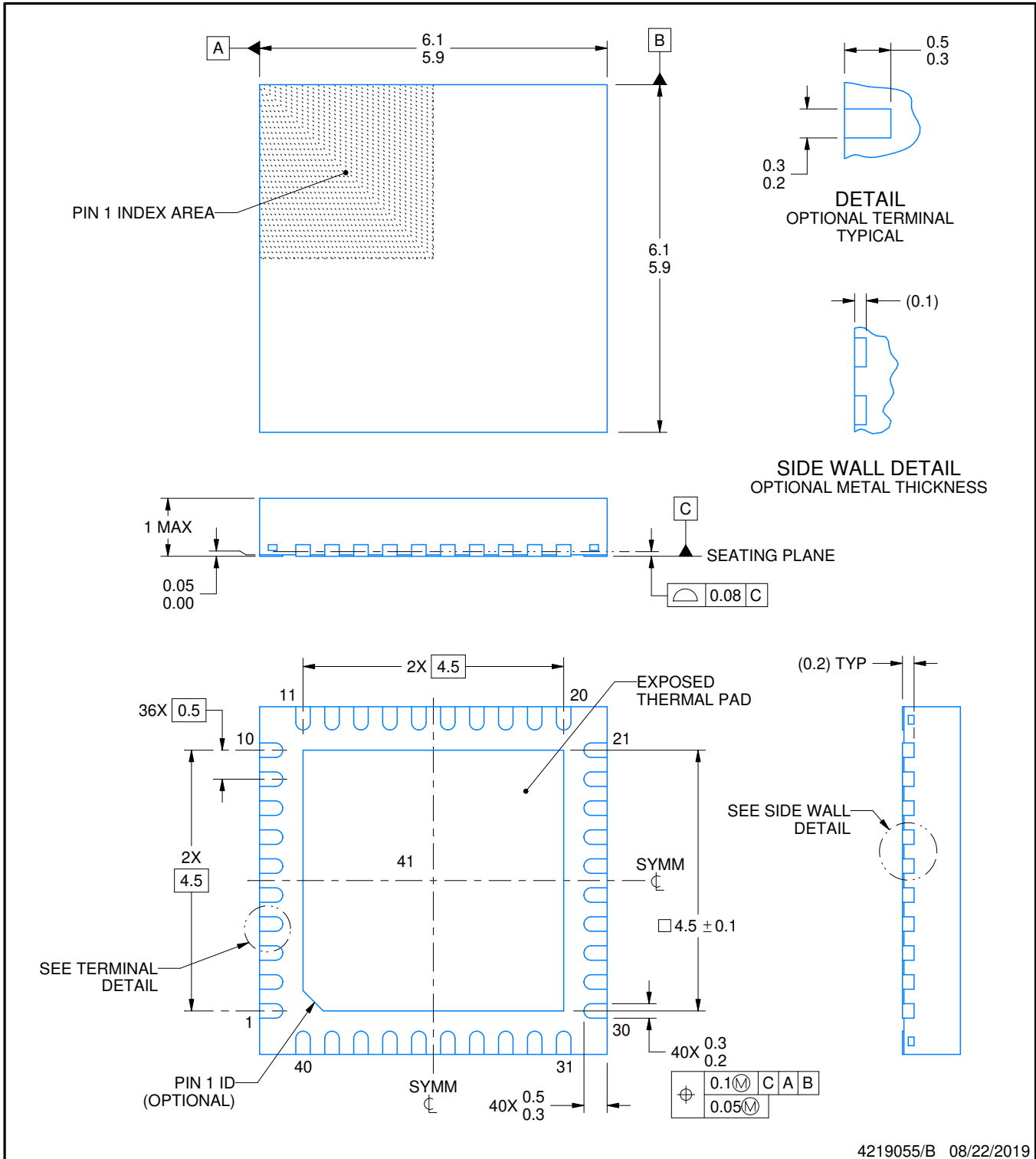

NOTES:

1. All linear dimensions are in millimeters. Any dimensions in parenthesis are for reference only. Dimensioning and tolerancing per ASME Y14.5M.
2. This drawing is subject to change without notice.
3. The package thermal pad must be soldered to the printed circuit board for thermal and mechanical performance.

EXAMPLE BOARD LAYOUT

RHA0040H

VQFN - 1 mm max height

PLASTIC QUAD FLATPACK - NO LEAD

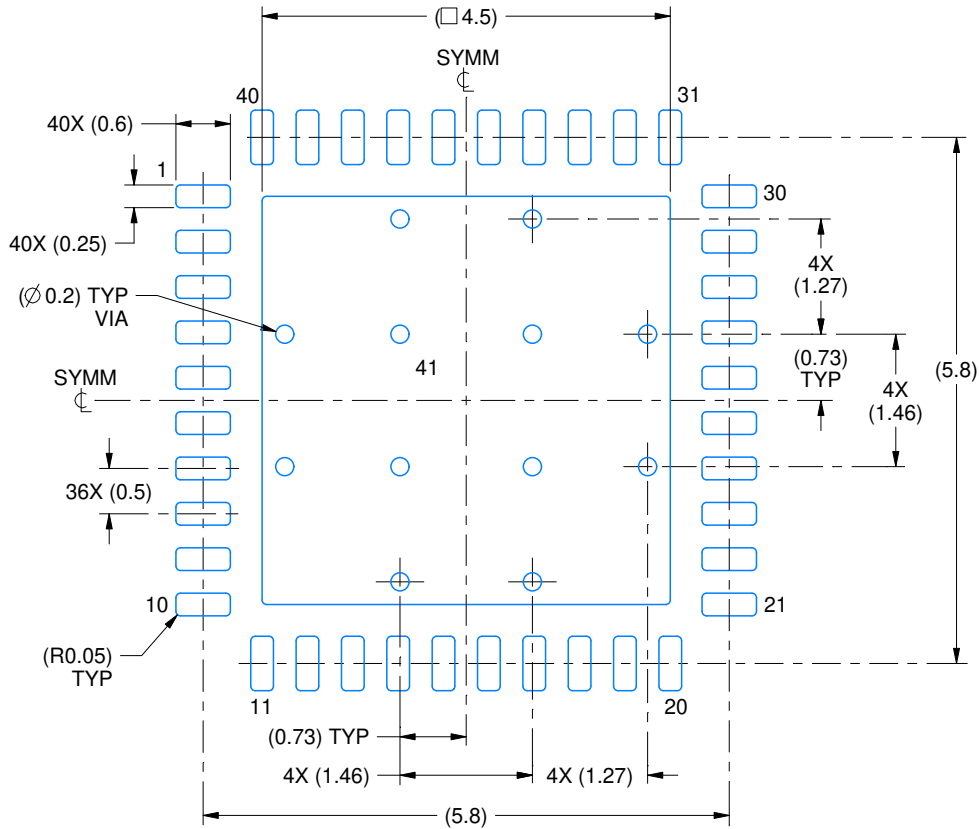

LAND PATTERN EXAMPLE
EXPOSED METAL SHOWN
SCALE:12X

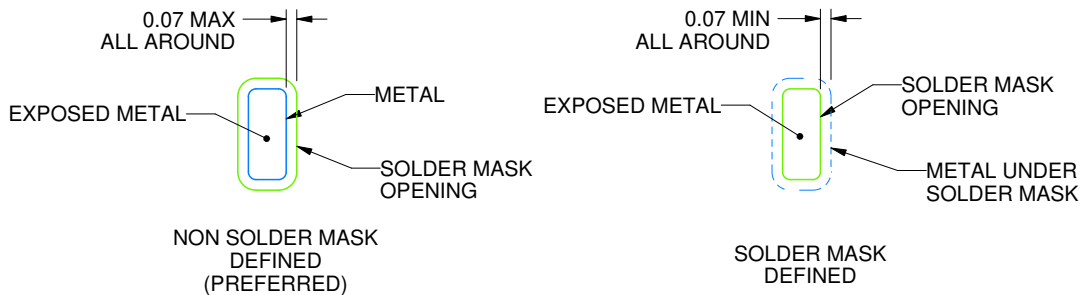

SOLDER MASK DETAILS

4219055/B 08/22/2019

NOTES: (continued)

- This package is designed to be soldered to a thermal pad on the board. For more information, see Texas Instruments literature number SLUA271 (www.ti.com/lit/sluea271).
- Vias are optional depending on application, refer to device data sheet. If any vias are implemented, refer to their locations shown on this view. It is recommended that vias under paste be filled, plugged or tented.

EXAMPLE STENCIL DESIGN

RHA0040H

VQFN - 1 mm max height

PLASTIC QUAD FLATPACK - NO LEAD

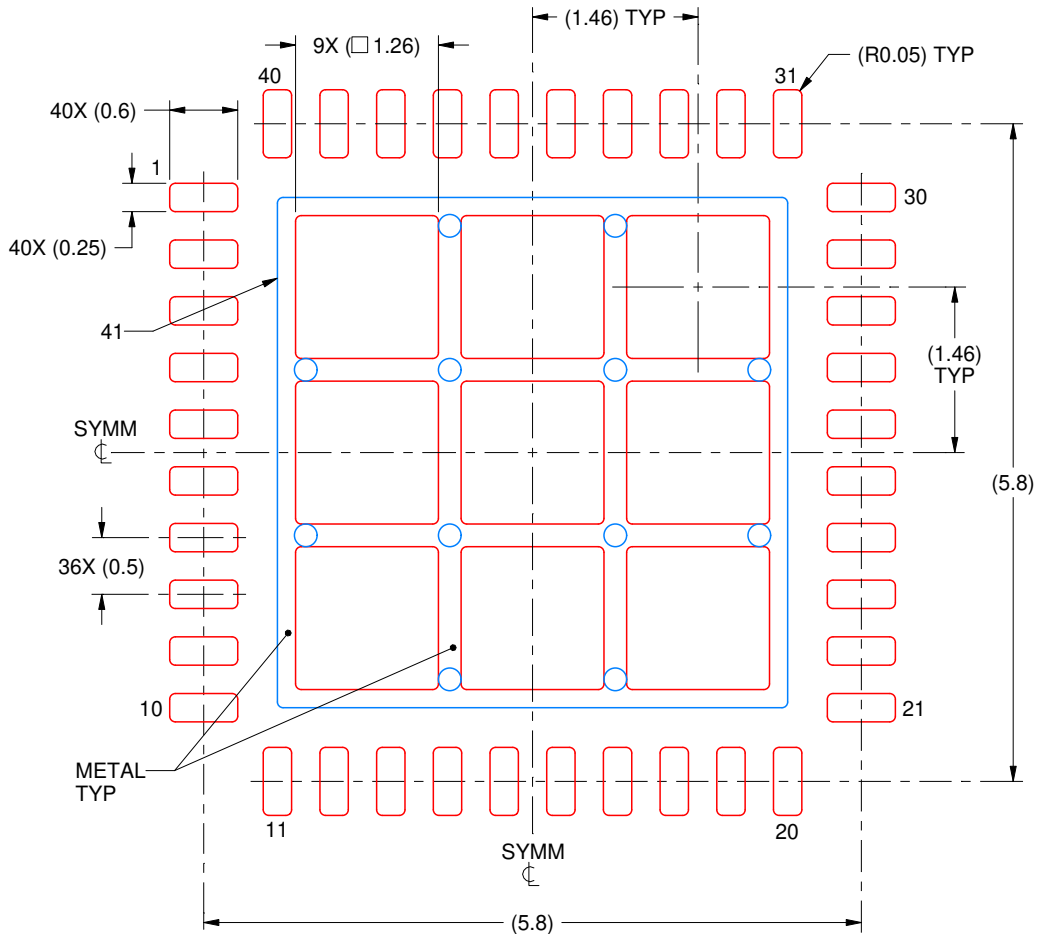

SOLDER PASTE EXAMPLE
BASED ON 0.125 mm THICK STENCIL

EXPOSED PAD 41:
70% PRINTED SOLDER COVERAGE BY AREA
SCALE:15X

4219055/B 08/22/2019

NOTES: (continued)

6. Laser cutting apertures with trapezoidal walls and rounded corners may offer better paste release. IPC-7525 may have alternate design recommendations.

IMPORTANT NOTICE AND DISCLAIMER

TI PROVIDES TECHNICAL AND RELIABILITY DATA (INCLUDING DATA SHEETS), DESIGN RESOURCES (INCLUDING REFERENCE DESIGNS), APPLICATION OR OTHER DESIGN ADVICE, WEB TOOLS, SAFETY INFORMATION, AND OTHER RESOURCES "AS IS" AND WITH ALL FAULTS, AND DISCLAIMS ALL WARRANTIES, EXPRESS AND IMPLIED, INCLUDING WITHOUT LIMITATION ANY IMPLIED WARRANTIES OF MERCHANTABILITY, FITNESS FOR A PARTICULAR PURPOSE OR NON-INFRINGEMENT OF THIRD PARTY INTELLECTUAL PROPERTY RIGHTS.

These resources are intended for skilled developers designing with TI products. You are solely responsible for (1) selecting the appropriate TI products for your application, (2) designing, validating and testing your application, and (3) ensuring your application meets applicable standards, and any other safety, security, regulatory or other requirements.

These resources are subject to change without notice. TI grants you permission to use these resources only for development of an application that uses the TI products described in the resource. Other reproduction and display of these resources is prohibited. No license is granted to any other TI intellectual property right or to any third party intellectual property right. TI disclaims responsibility for, and you will fully indemnify TI and its representatives against, any claims, damages, costs, losses, and liabilities arising out of your use of these resources.

TI's products are provided subject to [TI's Terms of Sale](#) or other applicable terms available either on [ti.com](https://www.ti.com) or provided in conjunction with such TI products. TI's provision of these resources does not expand or otherwise alter TI's applicable warranties or warranty disclaimers for TI products.

TI objects to and rejects any additional or different terms you may have proposed.

Mailing Address: Texas Instruments, Post Office Box 655303, Dallas, Texas 75265
Copyright © 2023, Texas Instruments Incorporated