

A

B

C

D

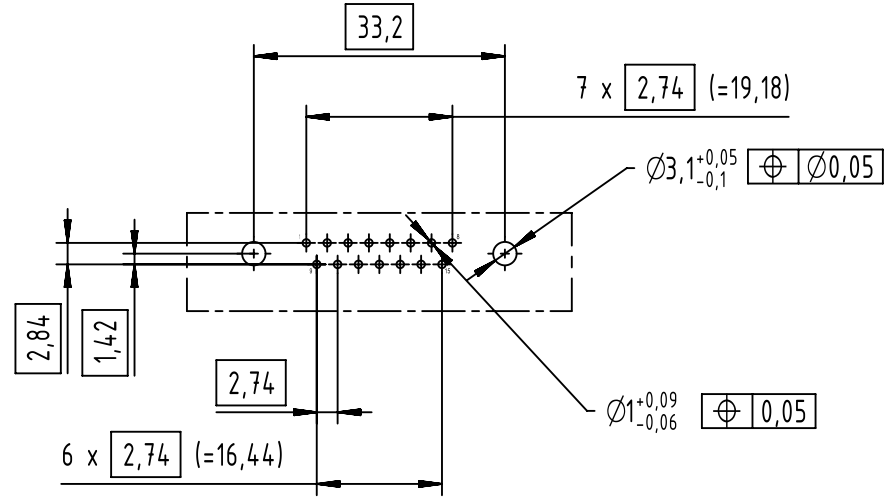
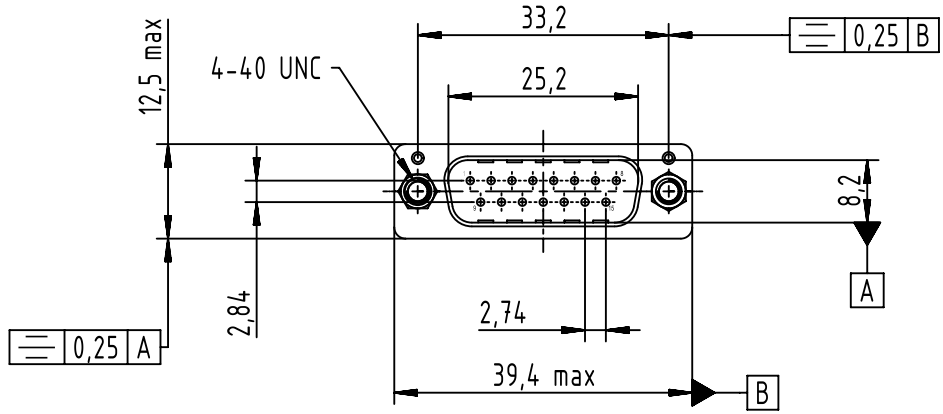
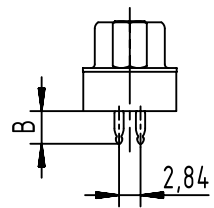
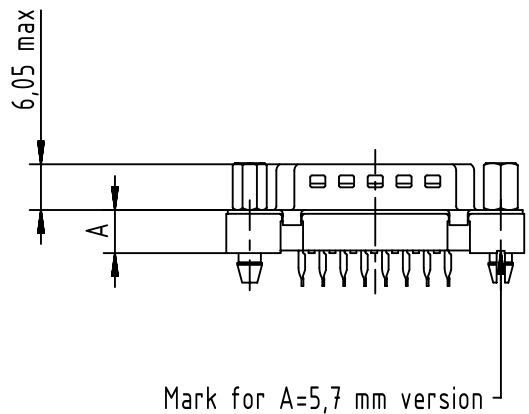

09662647717	3	5,7	4,35
09662646717	2	5,7	4,35
09662645717	S4 PdNi	5,7	4,35
Part number	Performance level	A +/- 0,2	B +/- 0,2

	All rights reserved		Scale 1:1		Free size tol.		Ref.		
	Department EC PD - FR		Created by DOUGE	Inspected by BAGDIKIAN	Standardisation HOFFMANN	Date 2014-04-04	State Final Release		
HARTING Electronics GmbH			Title D-Sub 15-pole male straight press-in				Doc-Key / ECM-Nr. 100571289/UGD/001/A 500000072522		
D-32339 Espelkamp			Type TB	Number 0966264X717			Rev. A	Page 1/1	