

A08 - ADAPTOR FOR DIN B

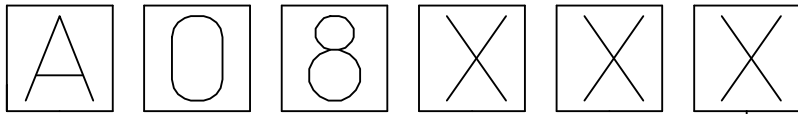

INTERNAL CIRCUIT

VOLTAGE AND LED COLOUR:

1= 12V	A= 12V	G= 12V
2= 24V	B= 24V	H= 24V
3= 48V	C= 48V	K= 48V
4= 115V	D= 115V	L= 115V
5= 230V	E= 230V	M= 230V

RED LED      GREEN LED      YELLOW LED

Chart 1

Engineering no.	SAP Part Number	Circuit type	LED Color
A08C4B	1210010291	C4 24V	Green
A08C4H	1210010292	C4 24V	Yellow
A08C4M	1210010294	C4 230V	Yellow
A08S0H	1210010426	S0 24V	Yellow
A08A1L	1210010428	A1 115V	Yellow
A08G2M	1210010433	G2 230V	Yellow
A08C4L	1210010439	C4 115V	Yellow

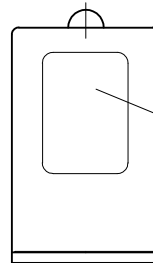

CIRCUIT TAMPOPRINT (WHITE)

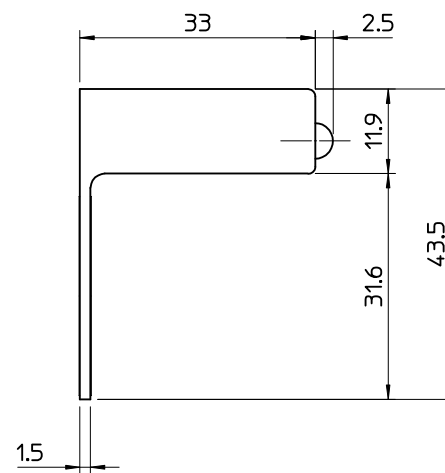
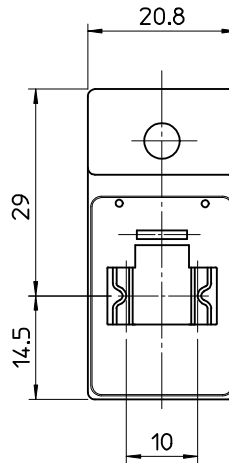

Wiring configuration

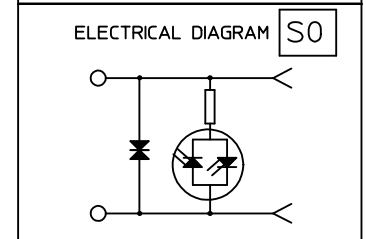
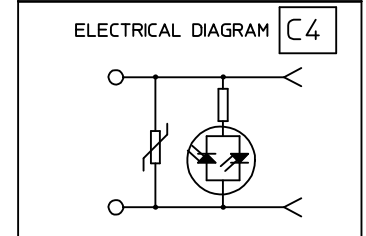
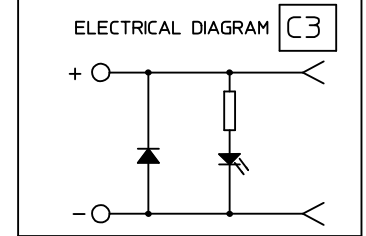
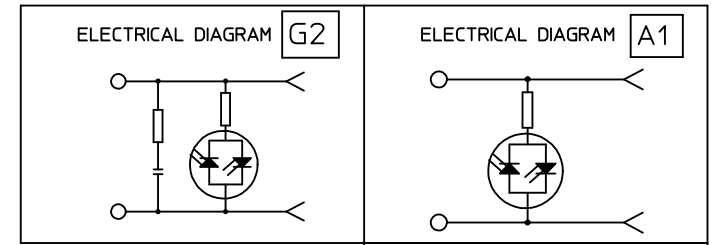

ORIGINAL RELEASE EC NO: IPG2013-1225 DRWN: JMARSZALEK 2013/02/11 CHKD: MSZWAJKOWSKI 2013/02/11 APPR: MIWASIECZKO 2013/02/12	QUALITY SYMBOLS ▽=0 ▽=0	GENERAL TOLERANCES (UNLESS SPECIFIED)		DIMENSION STYLE MM ONLY		SCALE -	DESIGN UNITS METRIC	FIRST ANGLE PROJECTION LIGHTS ADAPTORS SERIES A08XXX FOR DIN B <b>molex</b>	
				DRAWN BY DATE JMARSZALEK 2013/02/11		TITLE			
				CHECKED BY DATE MSZWAJKOWSKI 2013/02/11		DOCUMENT NO. SD-121001-008			
				APPROVED BY DATE MIWASIECZKO 2013/02/12		SHEET NO. 1 OF 1			
A	REV	ANGULAR ±---°		MATERIAL NO.					
		DRAFT WHERE APPLICABLE MUST REMAIN WITHIN DIMENSIONS		SEE CHART 1					
				SIZE A4		THIS DRAWING CONTAINS INFORMATION THAT IS PROPRIETARY TO MOLEX INCORPORATED AND SHOULD NOT BE USED WITHOUT WRITTEN PERMISSION			