

THIS DRAWING IS UNPUBLISHED.

RELEASED FOR PUBLICATION

2010

© COPYRIGHT 2010

BY TYCO ELECTRONICS CORPORATION. ALL INTERNATIONAL RIGHTS RESERVED.

LOC
J

DIST
-

REVISIONS

| P | LTR | DESCRIPTION | DATE | DWN | APVD |
|---|-----|---------------------------|-----------|-----|------|
| | A | RELEASED | 15NOV2010 | Y.O | N.Y |
| | A1 | REVISED, ECR-10-024232 | 24NOV2010 | Y.O | N.Y |
| | A2 | REVISED, ECR-10-025026 | 07DEC2010 | Y.O | N.Y |
| | B | REVISED PER ECR-22-153759 | 10JUL2023 | MV | DZ |

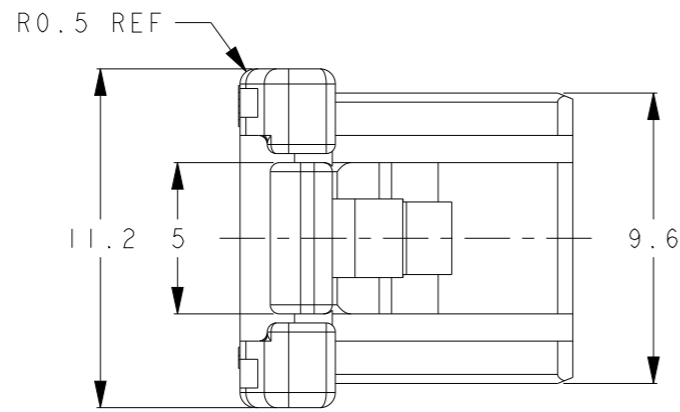

TYPE OF KEYING $\square\square\square$ 3:1
SCALE 3:1

TYPE A

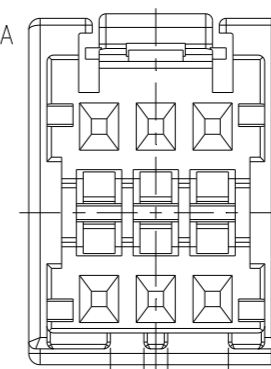

TYPE B

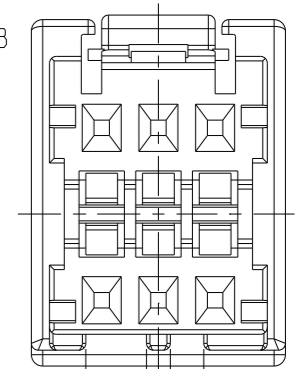

TYPE C

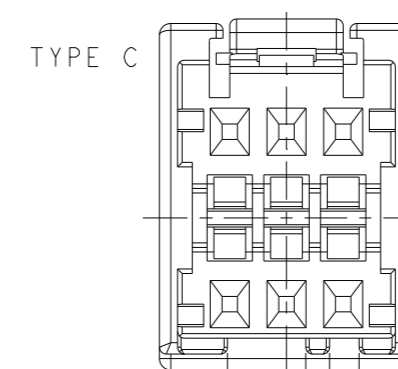

TYPE D

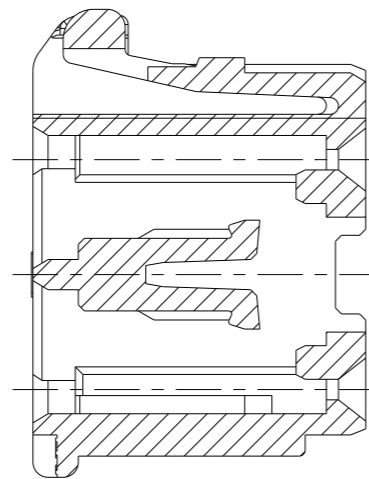
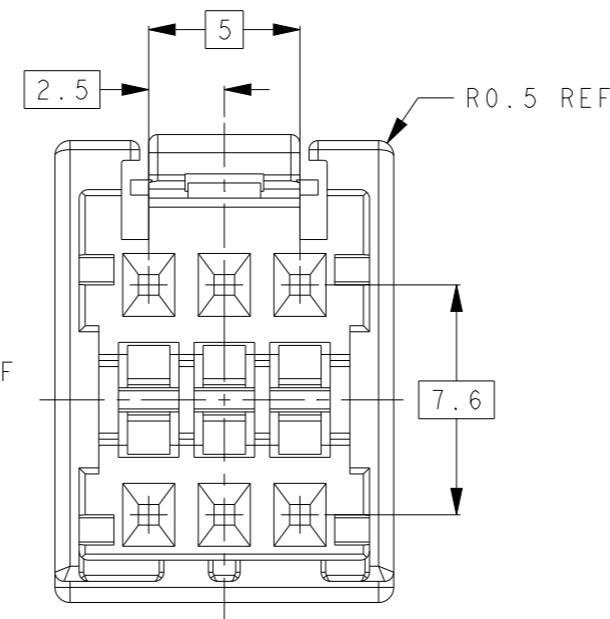
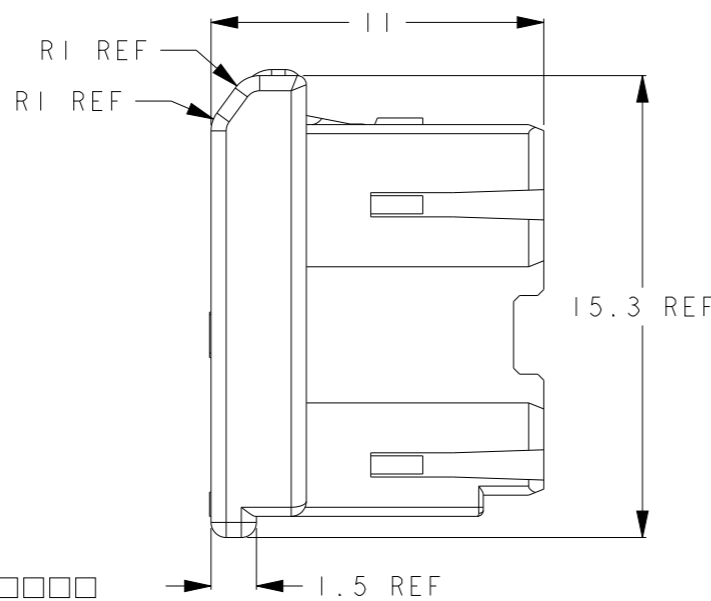
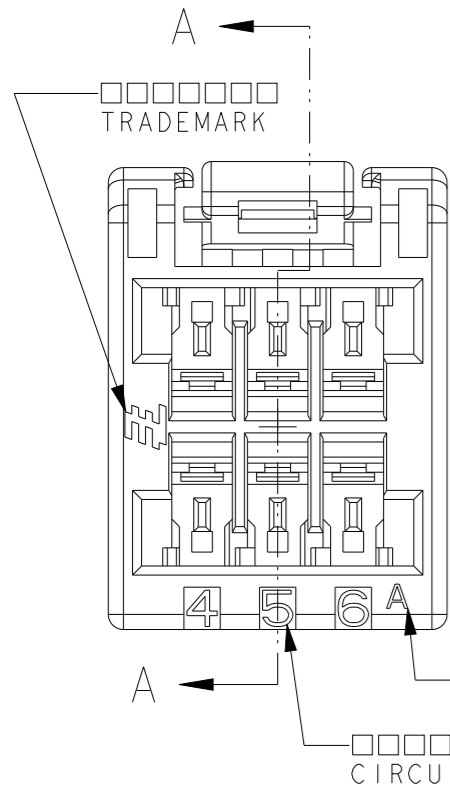
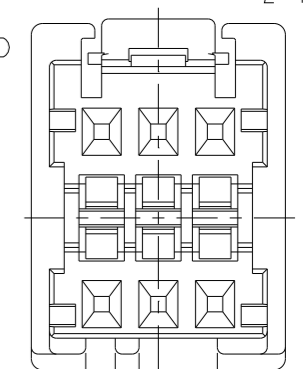

A - A

| | | | |
|-------------------------|----------------|---------------------------------------|------------------|
| 4-2134904-2 | TYPE B | BLACK $\square\square$ | 4-2134905-2 |
| 3-2134904-4 | TYPE D | YELLOW $\square\square$ | 3-2134905-4 |
| 2-2134904-3 | TYPE C | BLUE $\square\square$ | 2-2134905-3 |
| 1-2134904-2 | TYPE B | RED $\square\square$ | 1-2134905-2 |
| 2134904-1 | TYPE A | NATURAL $\square\square$ | 2134905-1 |
| $\square\square\square$ | \triangle | $\square\square\square\square\square$ | $\square\square$ |
| MATING HSG P/N | TYPE OF KEYING | COLOR | PART NUMBER |

- 1 $\square\square\square\square\square\square$ PBT UL94V-0
- 2 $\square\square\square\square\square\square\square\square$
- 3 $\square\square\square\square\square$: 917683-1, 917684-1

- 1 MATERIAL: GLASS FILLED PBT (UL94V-0)
- 2 MATING HOUSING P/N: SEE TABLE
- 3 APPLICABLE CONTACT: 917683-1, 917684-1

THIS DRAWING IS A CONTROLLED DOCUMENT FOR TYCO ELECTRONICS CORPORATION. IT IS SUBJECT TO CHANGE AND THE CONTROLLING ENGINEERING ORGANIZATION SHOULD BE CONTACTED FOR THE LATEST REVISION.

DIMENSIONS:
 $\square\square$: \square
mm

TOLERANCES UNLESS OTHERWISE SPECIFIED:
 $\square\square\square \pm$ -
0 PLC \pm
1 PLC \pm
2 PLC \pm
3 PLC \pm
4 PLC \pm
ANGLES \pm

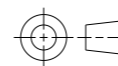

MATERIAL
 $\square\square$



FINISH
 $\square\square$

DWN Y. OKADA 15NOV2010

CHK S. YAMADA 15NOV2010

APVD N. YAMASAKI 15NOV2010

PRODUCT SPEC
 $\square\square\square$
108-78350

APPLICATION SPEC
 $\square\square\square\square$

WEIGHT 1.17

CUSTOMER DRAWING

NAME

$\square\square$

Tyco Electronics Tyco Electronics Corporation
Kawasaki, Japan

GRACE INERTIA CONNECTOR 2.5W
PLUG HOUSING 6P

SIZE CAGE CODE DRAWING NO RESTRICTED TO

A300779 C-2134905

SCALE 3:1 SHEET 1 OF 1 REV B