

### 3HE05036AA-DW4932-C

Alcatel-Lucent Nokia® 3HE05036AA-DW4932 Compatible TAA 10GBase-DWDM SFP+ Transceiver (SMF, 1549.32nm, 40km, LC, DOM)

#### Features:

- SFF-8432 and SFF-8472 Compliance
- Duplex LC Connector
- Temperature-stabilized EML transmitter and PIN receiver
- Single-mode Fiber
- Commercial Temperature 0 to 70 Celsius
- Hot Pluggable
- Metal with Lower EMI
- Excellent ESD Protection
- RoHS Compliant and Lead Free



#### Applications:

- 10x Gigabit Ethernet over DWDM
- 8x/10x Fibre Channel
- Access, Metro and Enterprise

#### Product Description

This Alcatel-Lucent Nokia® 3HE05036AA-DW4932 compatible SFP+ transceiver provides 10GBase-DWDM throughput up to 40km over single-mode fiber (SMF) using a wavelength of 1549.32nm via an LC connector. It is guaranteed to be 100% compatible with the equivalent Alcatel-Lucent Nokia® transceiver. This easy to install, hot swappable transceiver has been programmed, uniquely serialized and data-traffic and application tested to ensure that it will initialize and perform identically. Digital optical monitoring (DOM) support is also present to allow access to real-time operating parameters. This transceiver is Trade Agreements Act (TAA) compliant. We stand behind the quality of our products and proudly offer a limited lifetime warranty.

ProLabs's transceivers are RoHS compliant and lead-free.

TAA refers to the Trade Agreements Act (19 U.S.C. & 2501-2581), which is intended to foster fair and open international trade. TAA requires that the U.S. Government may acquire only "U.S. – made or designated country end products."



## Regulatory Compliance

- ESD to the Electrical PINs: compatible with MIL-STD-883E Method 3015.7.
- ESD to the Duplex LC Receptacle: compatible with IEC 61000-4-2
- Immunity compatible with IEC 61000-4-3.
- EMI compatible with FCC Part 15 Class B EN55022 Class B (CISPR 22B) VCCI Class B.
- Laser Eye Safety compatible with FDA 21CFR 1040.10 and 1040.11 EN60950, EN (IEC) 60825-1,2.
- RoHs compliant with 2002/95/EC 4.1&4.2 2005/747/EC.

## Wavelength Guide (100GHz ITU-T Channel)

Channel #	Frequency (THz)	Center Wavelength (nm)
17	191.7	1563.86
18	191.8	1563.05
19	191.9	1562.23
20	192.0	1561.42
21	192.1	1560.61
22	192.2	1559.79
23	192.3	1558.98
24	192.4	1558.17
25	192.5	1557.36
26	192.6	1556.55
27	192.7	1555.75
28	192.8	1554.94
29	192.9	1554.13
30	193.0	1553.33
31	193.1	1552.52
32	193.2	1551.72
33	193.3	1550.92
34	193.4	1550.12
35	193.5	1549.32
36	193.6	1548.51
37	193.7	1547.72
38	193.8	1546.92
39	193.9	1546.12
40	194.0	1545.32
41	194.1	1544.53
42	194.2	1543.73
43	194.3	1542.94

44	194.4	1542.14
45	194.5	1541.35
46	194.6	1540.56
47	194.7	1539.77
48	194.8	1538.98
49	194.9	1538.19
50	195.0	1537.40
51	195.1	1536.61
52	195.2	1535.82
53	195.3	1535.04
54	195.4	1534.25
55	195.5	1533.47
56	195.6	1532.68
57	195.7	1531.90
58	195.8	1531.12
59	195.9	1530.33
60	196.0	1529.55
61	196.1	1528.77

### Absolute Maximum Ratings

Parameter	Symbol	Min.	Typ	Max.	Unit
Storage Temperature	TS	-40		85	°C
Supply Voltage	Vcc	-0.5		4.0	V
Operating Case Temperature	Tc	0	25	70	°C
Relative Humidity	RH	5		95	%
Data Rate			10.3125		Gb/s

## Electrical Characteristics

Parameter		Symbol	Min.	Typ.	Max.	Unit	Notes
Supply Voltage		Vcc	3.135	3.3	3.465	V	
Module Supply Current		Icc			450	mA	
Power Dissipation		PD			1500	mW	
<b>Transmitter</b>							
Input Differential Impedance		Zin		100		$\Omega$	
Differential Data Input Swing		Vin,p-p	180		700	mVp-p	
TX_FAULT	Transmitter Fault	VOH	2.0		VccHost	V	
	Normal Operation	VOL	0		0.8	V	
TX_DISABLE	Transmitter Disable	VIH	2.0		VccHost	V	
	Transmitter Enable	VIL	0		0.8	V	
<b>Receiver</b>							
Output Differential Impedance		Zo		100		$\Omega$	
Differential Data Output Swing		Vout,p-p	300		850	mVp-p	1
Data Output Rise Time, Fall Time		tr, tf	28			ps	2
RX_LOS	Loss of Signal (LOS)	VOH	2.0		VccHost	V	3
	Normal Operation	VOL	0		0.8	V	3

### Notes:

1. Internally AC coupled, but requires an external 100 $\Omega$  differential load termination.
2. 20-80%.
3. LOS is an open collector output. Should be pulled up with 4.7K $\Omega$  on the host board.

## Optical Characteristics

Parameter		Symbol	Min.	Typ.	Max.	Unit	Notes
<b>Transmitter</b>							
Launch Optical Power		PO	-1		4	dBm	1
Center Wavelength Range		$\lambda_c$	1528.77		1563.86	nm	
Center Wavelength Spacing				100		GHZ	
Center Wavelength Tolerance		$\Delta\lambda_c$	-100		100	pm	
Extinction Ratio		EX	8.2			dB	
Side Mode Suppression Ratio		SMSR	30			dB	
Transmitter and Dispersion Penalty		TDP			2.0	dB	
Relative Intensity Noise		RIN			-128	dB/Hz	

<b>Optical Return Loss Tolerance</b>	ORLT			21	dB	
<b>Pout @ TX-Disable Asserted</b>	Poff			-30	dBm	
<b>Eye Diagram</b>	IEEE Std 802.3-2005 10Gb Ethernet 10GBASE-ER compatible					
<b>Receiver</b>						
<b>Center Wavelength</b>	$\lambda_c$	1528		1565	nm	
<b>Receiver Sensitivity (Pavg)</b>	S			-15	dBm	
<b>Receiver Overload (Pavg)</b>	POL	-1			dBm	
<b>Optical Return Loss</b>	ORL	26			dB	
<b>LOS De-Assert</b>	LOSD			-16	dBm	
<b>LOS Assert</b>	LOSA	-35			dBm	
<b>LOS Hysteresis</b>		0.5			dB	

**Notes:**

1. The optical power is launched into 9/125 $\mu$ m SMF.
2. Measured with a PRBS 2<sup>31</sup>-1 test pattern @10.3125Gbps.
3. Measured with PRBS 2<sup>31</sup>-1 test pattern, 10.3125Gb/s, BER<10<sup>-12</sup>.
4. Comply with IEEE 802.3-2005.

## Pin Descriptions

Pin	Symbol	Name/Descriptions	Ref.
1	VeeT	Transmitter Ground	1
2	TX_Fault	Transmitter Fault (LVTTTL-O) - High indicates a fault condition	2
3	TX_Disable	Transmitter Disable (LVTTTL-I) – High or open disables the transmitter	3
4	SDA	Two wire serial interface Data Line (LVCMOS-I/O) (MOD-DEF2)	4
5	SCL	Two wire serial interface Clock Line (LVCMOS-I/O) (MOD-DEF1)	4
6	MOD_ABS	Module Absent (Output), connected to VeeT or VeeR in the module	5
7	RS0	Rate Select 0 – Not used, Presents high input impedance	
8	RX_LOS	Receiver Loss of Signal (LVTTTL-O)	2
9	RS1	Rate Select 1 – Not used, Presents high input impedance	
10	VeeR	Receiver Ground	1
11	VeeR	Receiver Ground	1
12	RD-	Inverse Received Data out (CML-O)	
13	RD+	Received Data out (CML-O)	
14	VeeR	Receiver Ground	
15	VccR	Receiver Power - +3.3V	
16	VccT	Transmitter Power - +3.3 V	
17	VeeT	Transmitter Ground	1
18	TD+	Transmitter Data In (CML-I)	
19	TD-	Inverse Transmitter Data In (CML-I)	
20	VeeT	Transmitter Ground	1

### Notes:

1. The module signal grounds are isolated from the module case.
2. This is an open collector/drain output that on the host board requires a 4.7K $\Omega$  to 10K $\Omega$  pull-up resistor to VccHost.
3. This input is internally biased high with a 4.7K $\Omega$  to 10K $\Omega$  pull-up resistor to VccT.
4. Two-Wire Serial interface clock and data lines require an external pull-up resistor dependent on the capacitance load.
5. This is the ground return that on the host board requires a 4.7K $\Omega$  to 10K $\Omega$  pull-up resistor to VccHost.



Figure 1. Host PCB SFP+ pad assignment top view

### Recommended Host Board Power Supply Filter Network

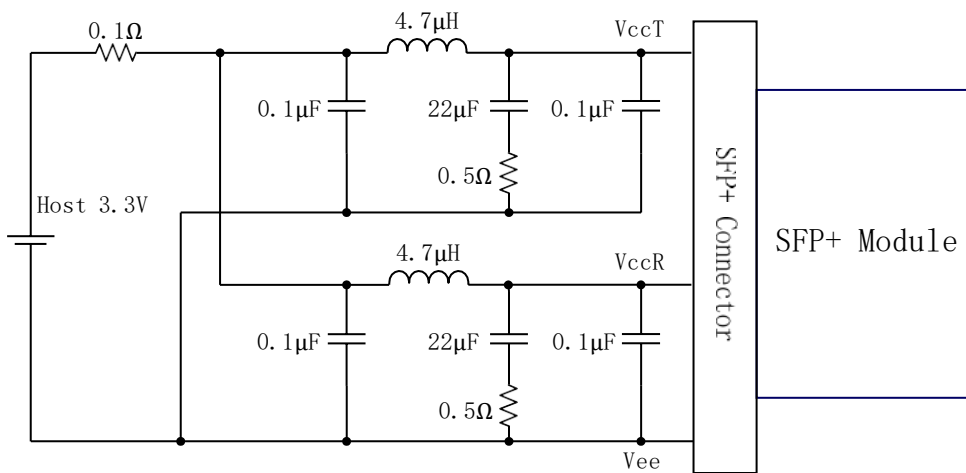

Figure 2. Recommended Host Board Power Supply Filter Network

## Recommended Application Interface Block Diagram



## Mechanical Specifications

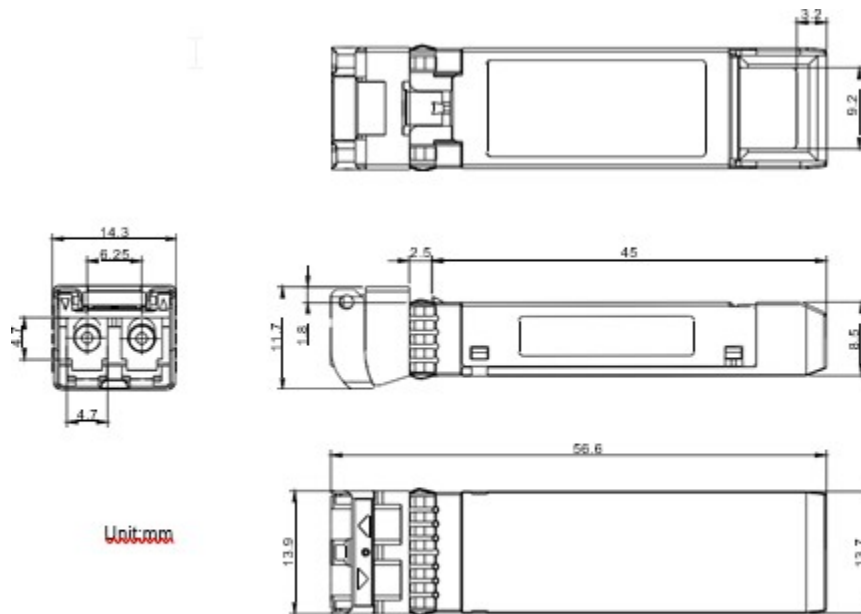

Figure 4. Outline Drawing





## **About ProLabs**

Our experience comes as standard; for over 15 years ProLabs has delivered optical connectivity solutions that give our customers freedom and choice through our ability to provide seamless interoperability. At the heart of our company is the ability to provide state-of-the-art optical transport and connectivity solutions that are compatible with over 90 optical switching and transport platforms.

## **Complete Portfolio of Network Solutions**

ProLabs is focused on innovations in optical transport and connectivity. The combination of our knowledge of optics and networking equipment enables ProLabs to be your single source for optical transport and connectivity solutions from 100Mb to 400G while providing innovative solutions that increase network efficiency. We provide the optical connectivity expertise that is compatible with and enhances your switching and transport equipment.

## **Trusted Partner**

Customer service is our number one value. ProLabs has invested in people, labs and manufacturing capacity to ensure that you get immediate answers to your questions and compatible product when needed. With Engineering and Manufacturing offices in the U.K. and U.S. augmented by field offices throughout the U.S., U.K. and Asia, ProLabs is able to be our customers best advocate 24 hours a day.

## **Contact Information**

ProLabs US

Email: [sales@prolabs.com](mailto:sales@prolabs.com)

Telephone: 952-852-0252

ProLabs UK

Email: [salessupport@prolabs.com](mailto:salessupport@prolabs.com)

Telephone: +44 1285 719 600