

Right Angle Female

Series 7200 – Style C 11, 55 Contacts

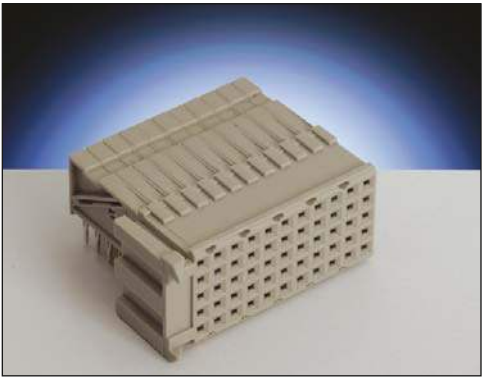

- 55 signal contacts in 5 rows of 11 positions
- Daughter card applications
- Designed for gas tight press-fit installations
- Available with bottom pegs for secure P.C. board mounting
- This connector is designed for end positions only
- Available with or without upper ground return shield
- Reduced crosstalk version available (see page 19)
- Lower ground return shield available (see page 19)



DIMENSIONS: millimeters (inches)

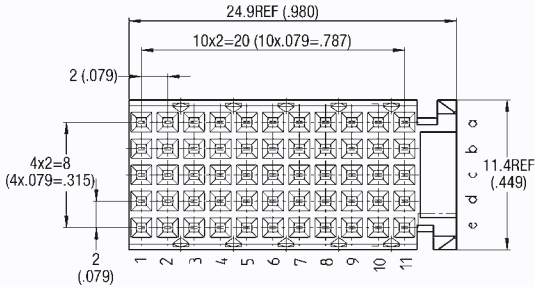
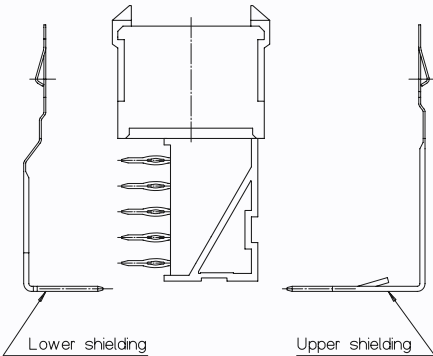
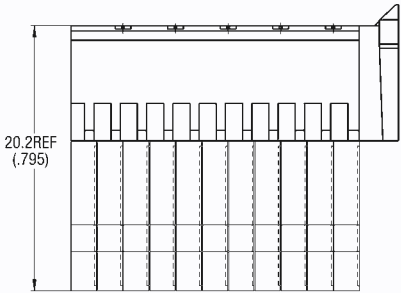

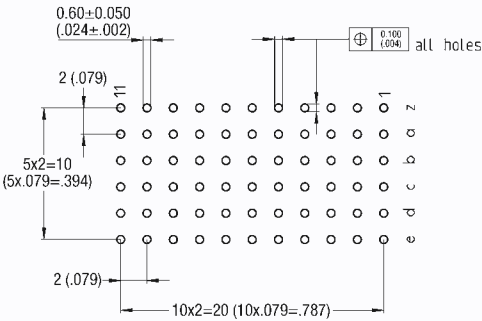

LAYOUT



Right Angle Female

Style C 11 – 55 Contacts

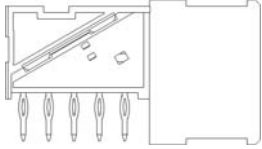
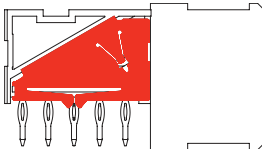
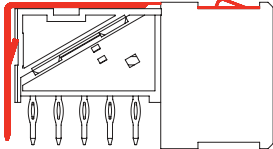
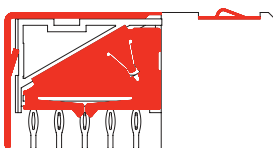

Shielding Version	Cavity	Performance Class	Part Number
<p>Without Shield</p> 	55	2	27 7200 055 400 002
<p>Reduced Crosstalk</p> 	55	2	27 7200 055 401 002
<p>Upper Shield</p> 	55	2	27 7200 055 402 002
<p>Upper Shield and Reduced Crosstalk</p> 	55	2	27 7200 055 403 002
<p>Lower Shield</p> 		2	67 7200 2613 00 675

Technical description and dimensions see page 9 and 18