

HRS®

Main unit of crimping machine

Model **CM-105**

Applicable applicator

Model **AP105**

INSTRUCTION MANUAL



CAUTION :

Be sure to read this Instruction Manual carefully before using it to secure safety in operation. In addition, save this Instruction Manual so that it is available whenever necessary for review.

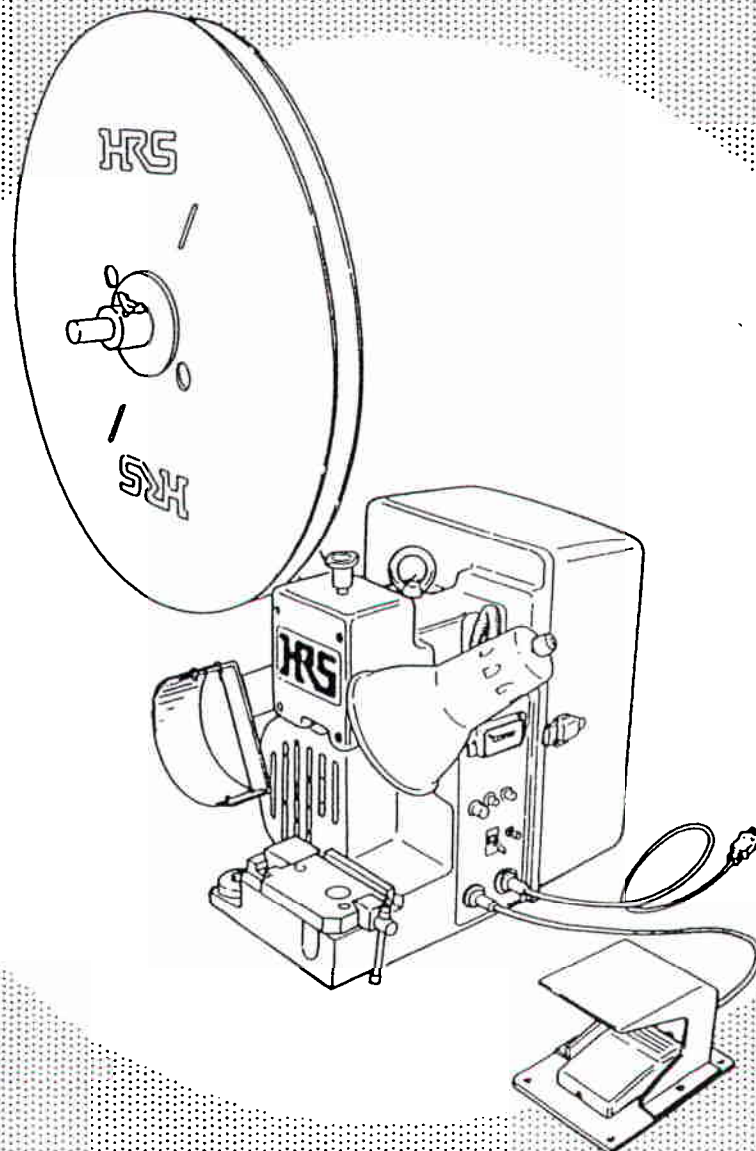



HIROSE ELECTRIC CO., LTD.

SAFETY INSTRUCTIONS

When operating this machine there is always the possibility of contact with the moving parts. The machine operator and maintenance personnel are required to read the following **SAFETY INSTRUCTIONS** so as to handle the machine taking care not to get hurt. To fully understand the description given in this Instruction Manual and the warning labels attached on the machine, the warning messages are used in accordance with the below-stated classification. Please be sure to thoroughly understand the messages and follow the instructions.





(I) Description of warning messages

 DANGER	Used in the case where it is assumed that misuse of the machine will expose the operator to immediate danger of major injury or death.
 WARNING	Used in the case where it is assumed that misuse of the machine can expose the operator to danger of major injury or death.
 CAUTION	Used in the case where it is assumed that misuse of the machine can expose the operator to danger of injury and can cause damage to property.

* Determine the degree of impairment referring to the below-stated classification.

- Major injury: Indicates the loss of eyesight, wounds, burns (hyperthermal burns and hypothermal burns), electric shocks, fracture of a bone, poisoning, etc. attended with aftereffect, requiring hospital treatment or attending-to-hospital treatment for an extended period of time.
- Injury (Minor injury): Indicates wounds, burns, electric shocks, etc. requiring neither hospital treatment nor attending-to-hospital treatment for an extended period of time.
- Damage to property: Indicates damage spread to premises, household goods, livestock and pets.

(II) Explanation of warning labels and indication labels

Warning label		* Danger of cuts on fingers is present. Never place fingers inside the safety cover.	Warning label		* Indicates extreme heat. If touching, you could get burns.
		* Rotating component is installed inside the cover.		Indication label	
		* Electrical components are installed inside. Danger of electric shocks is present.			

SAFETY INSTRUCTIONS



DANGER

1. To protect against shock hazards when opening the cover, first turn the power off. Then, wait for a minimum of five minutes before opening the cover.

* For the purpose of this manual, an accident is an event that causes personal injury or damage to property.



CAUTION

Basic safety instructions

1. Be sure to read this Instruction Manual and any other instructions or materials supplied with the unit as accessories. Keep this Instruction Manual carefully and make it available for reference.

Safety device and warning labels

1. To avoid possible accidents due to lack of the safety device, be sure to operate the machine after ascertaining that the safety device is properly installed at the predetermined position. Refer to page iv for detailed description of the safety device.
2. If the safety device is detached from the machine for any reason, replace it to its original position and check to be sure that it normally functions.
3. Be sure to maintain the warning labels on the machine. They should be clear and visible at all times. If any of the warning labels should come off or become soiled/damaged, replace it with a new one.

Application

1. This machine shall only be used as specified in this Instruction Manual.
2. Modifications to this machine is prohibited. We assume no responsibility for accidents resulting from modifications.

Operating environment

1. To avoid accidents caused by malfunction, the machine shall be operated under an environment that is not affected by high noise sources (electromagnetic waves) such as high-frequency welders.
2. To avoid accidents caused by malfunction, the machine shall not be used in such an environment that would subject it to any voltage rating outside of "rated voltage $\pm 10\%$ ".
3. The machine shall be used under the following environment for safety.

Atmospheric temperature under operating conditions	5°C to 35°C
Relative humidity under operating conditions	35% to 85 %
4. Condensation can be observed when the environment of the machine is changed abruptly from cold to warm. To avoid accidents or damage, do not operate this machine in condition where the humidity is greater than the upper limit of the relative humidity specified above.
5. To avoid accidents caused by a damaged electrical part function, in the event of thunder and lightning, stop your work and pull out the power plug.

Training

1. To prevent possible accidents caused by unfamiliarity with the operation of the machine, the machine should only be operated by fully trained personnel.
It is recommended that a training procedure be established by the employer and that the operator be provided with this Instruction Manual for reference.

Working wear

1. To protect against possible accidents resulting in personal injury or damage to personal property (i.e., clothing), be sure wear a work uniform or fit clothing with sleeve cuffs fastened.
2. The operator should secure their hair with a hat or ponytail to protect his/her hair from being caught in the machine.
3. The operator should wear safe, rubber bottom, close toe shoes or work boots.

Event that requires turn-off of the power

1. In the event of abnormal conditions, machine failure or power failure, the power should be turned off immediately.
2. To protect against possible accidents caused by abrupt start of the machine, the power must be turned off before conducting inspection, repair, or cleaning. Be sure to turn the power off when the operator leaves the machine.
3. To pull out the power plug, hold the plug rather than the cord.

* "Turn-off the power" means turning off the power switch and pulling the power plug out of the receptacle. (This applies to any case where the "turn-off the power" is hereinafter referred to.)

Safety instructions in each category of work following the delivery of the machine

Transportation

1. To protect against possible accident or damage, the machine should be lifted by two or more persons. Use an eye bolt attached on the machine and an apparatus, such as chain block, specifically designed to lift heavy cargo. To move the machine, a dolly is recommended.
2. The machine shall be lifted or moved in such a way that secures safety to avoid falling and dropping.
3. To protect against accidents or damage to the machine re-package, if necessary, to achieve the originally-delivered state. Prior to re-packaging, wipe off an oil gathered on the machine.

Unpacking

1. To protect against personal injury, carefully check the box for wood nails. Draw out nails from the boards.
2. The center of gravity of the machine is at the center of the eye bolt mounting section. Remove the machine out of the container carefully.

Installation

(I) Work bench

1. Use a table or a work bench that will sufficiently withstand the machine weight and the reaction force developed while the machine is in operation.
2. If casters are to be mounted on the main unit of the work bench, use durable casters provided with a locking mechanism.

(II) Cable and wiring

1. To prevent electric shocks, electrical leak or fire, be careful not to strain the cables at any time.
2. To protect against hazards from electric shocks, electrical leak and fire, multiple connection must be avoided. Plug the machine direct into a socket.
3. Connectors should be secured together. Pull out a connector, hold at the connector portion.

(III) Grounding

1. An Electrical Expert should be consulted to properly install an appropriate plug.
2. The connect the power plug to a properly grounded receptacle.
3. This will protect against hazards from electrical leak and isolation withstanding pressure.

Before operation

1. To protect against possible accidents resulting in injury or death, check to be sure that connectors and cables are in good condition and fastened securely.
2. To protect against possible accidents resulting in injury or death, never place hands in or near moving parts of the machine.



Lubrication

1. Use oil of the type designated by Hirose.
2. In the event that oil should gets in your eye or contact your skin, immediately wash skin or flush eyes to remove the oil. This will protect against irritations and rashes.
3. In the event that you should ingest oil by mistake, immediately consult a medical doctor to prevent illness.

Maintenance

1. To prevent possible accidents, repair and adjustment of the machine shall be conducted only by maintenance personnel who have been trained on the machine. Any repair and adjustment not specified in this Instruction Manual are prohibited. We assume no responsibility for accidents caused by improper repair or adjustment including the use of non-genuine part(s).
2. To protect against possible accidents and electric shock hazards, repair and maintenance work (including wiring) of electrical parts should be conducted by electrical technicians or Hirose engineers. In the event that electrical parts need repair and maintenance, please consult any of the aforementioned persons.
3. To protect against personal injury, check to be sure that screws and nuts are tightened after the completion of repair/adjusting and/or replacement of parts.
4. Periodically clean the machine as long as it is commissioned. To prevent possible accidents caused by an abrupt start of the machine during cleaning, be sure to turn the power off including unplugging it, before beginning cleaning.
5. In the event that your machine fails to perform normally after repair/adjusting works, immediately stop operation. Contact Hirose for service to protect against personal injury.

SAFETY INSTRUCTIONS TO BE FOLLOWED WHEN USING THE MAIN UNIT OF CRIMPING MACHINE MODEL CM-105

 DANGER	<ol style="list-style-type: none"> 1. To protect against shock hazards, open the cover, if necessary, after turning the power off and waiting for a minimum of five minutes.
 CAUTION	<ol style="list-style-type: none"> 1. To avoid possible accidents resulting in personal injury caused by being caught in the moving parts of the machine, extreme caution has to be taken to keep your hands, fingers, clothing, head or hair away from the moving parts and surrounding area. Also, do not place any matter that is not necessary in the use of the machine near any of the moving parts. 2. To protect against possible personal injury, when turning the power on, take care to keep your hands, fingers, clothing, head or hair away from the moving parts and the surrounding area. Also, do not place any matter that is not necessary in the use of the machine near any of the moving parts. 3. To protect against electric shock and accidents caused by any damaged electrical component, be sure to turn off the power switch before connecting or detaching the power plug. 4. To protect against possible accidents caused by any damaged electrical component, be sure to stop your work and disconnect the power plug for safety purposes in the case of thunder and lightning. 5. In the case where the machine is suddenly moved from a cold to warm weather conditions condensation can result. To protect against possible accidents due to any damaged electrical component, turn the power on only after making sure that no condensation is present.

SAFETY DEVICE

The machine and the safety device of which specifications are intended for the countries other than Japan may differ from the standard ones.

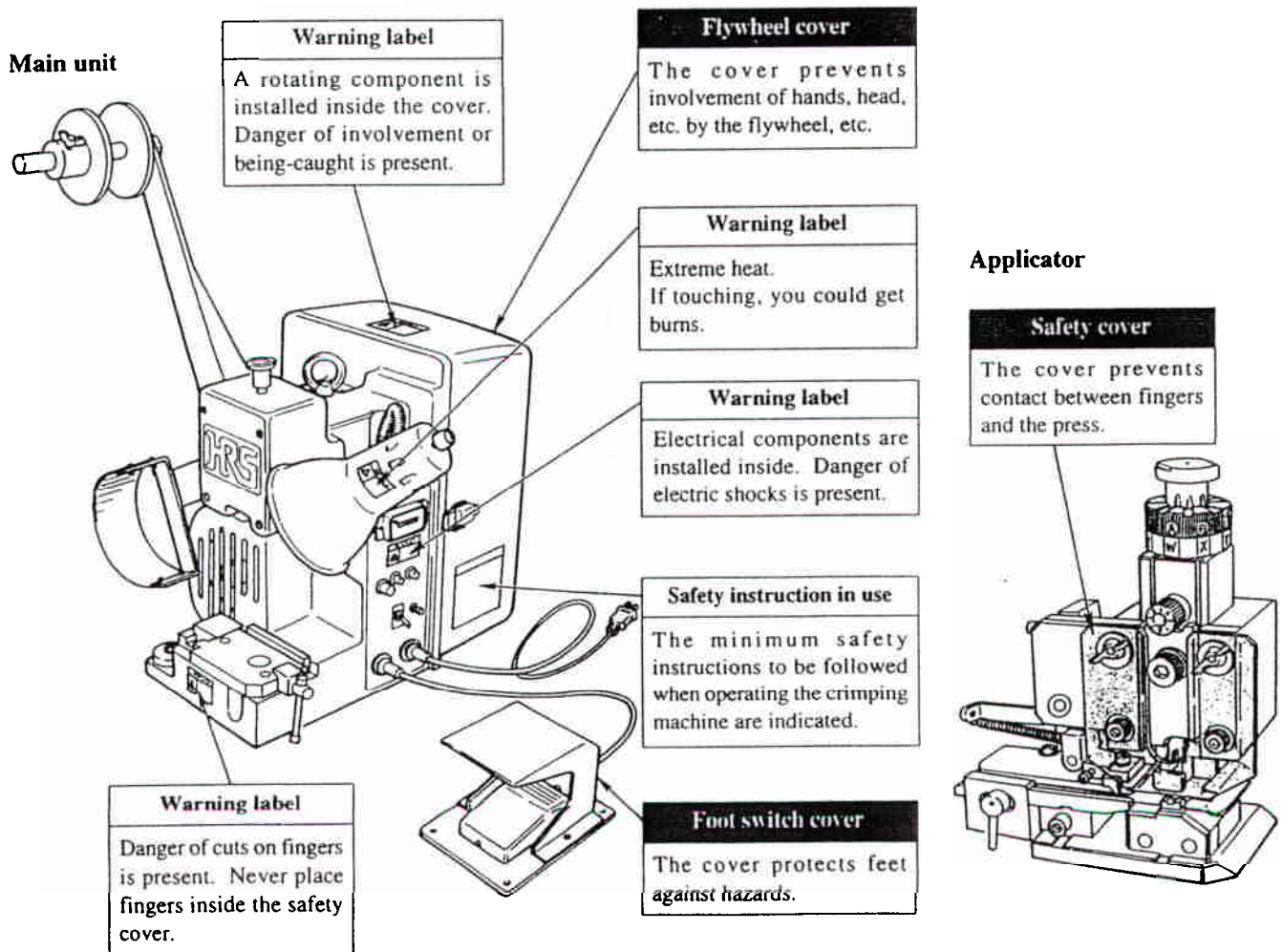

CONTENTS

1. MODEL	1
2. SPECIFICATIONS	1
3. CONFIGURATION	1
4. INSTALLATION	2
5. OPERATION	3
(1) Preparation	3
(2) Checking the performance before putting the machine into service	3
(3) Checking the operation	4
6. ATTACHING/DETACHING THE REEL TERMINAL	4
7. ATTACHING/DETACHING THE APPLICATOR.....	5
(1) Attaching the applicator	5
(2) Detaching the applicator	5
8. MAINTENANCE	6
(1) Lubrication.....	6
(2) Inspection	6
9. TROUBLESHOOTING	8
10. APPENDIX	11
(1) Electric wiring diagram	11
(2) Major component names	12

1. MODEL

Product No.	HRS No.
CM-105	CL901-0005-4

2. SPECIFICATIONS

Item	Specification
Pressure applied	14 x 10 ³ N (1.5 ton)
Stroke	30 mm
1 cycle (machine tact)	0.3 sec.
Power consumption	Motor 200 W, work light 40 W
Power supply	100 VAC
Outside dimensions (With the reel terminal attached)	900 mm (height) x 640 mm (width) x 410 mm (depth)
Weight	75 kg
Applicable applicator	Model AP105 Series

3. CONFIGURATION

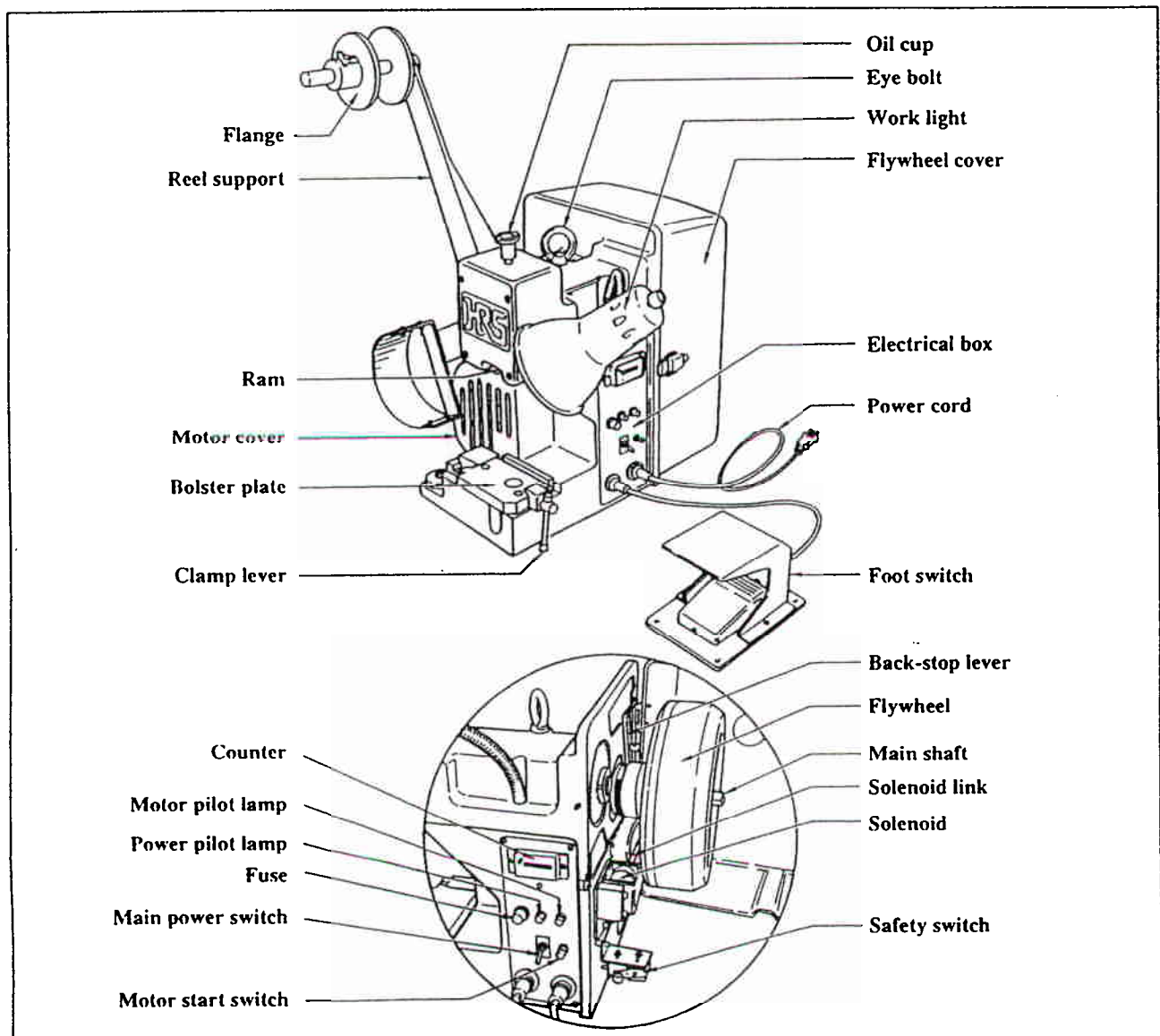

4. INSTALLATION



CAUTION :

This machine is heavy in weight. Moving or installation should be carried out by two or more persons. Take precautions not to allow the machine to fall or drop.

Dimensions of rubber mat recommended

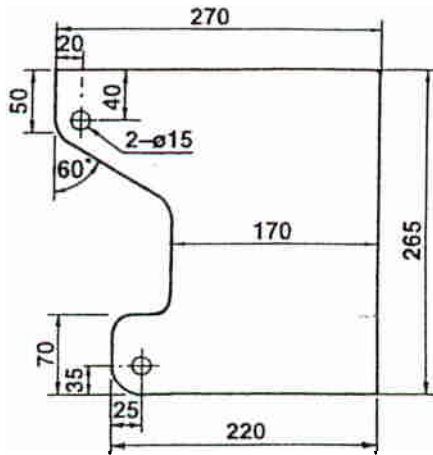
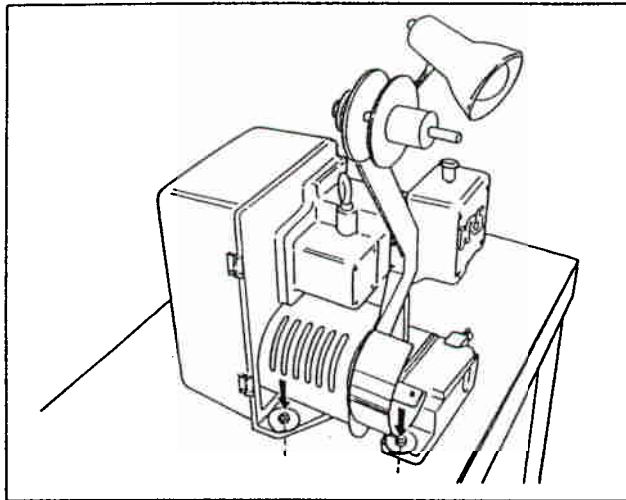

Fig 3

1) Place a rubber mat on the work bench that is stable and leveled. Place the machine on the rubber mat.



2) Fit the bolts in two mounting holes and tighten them.

5. OPERATION

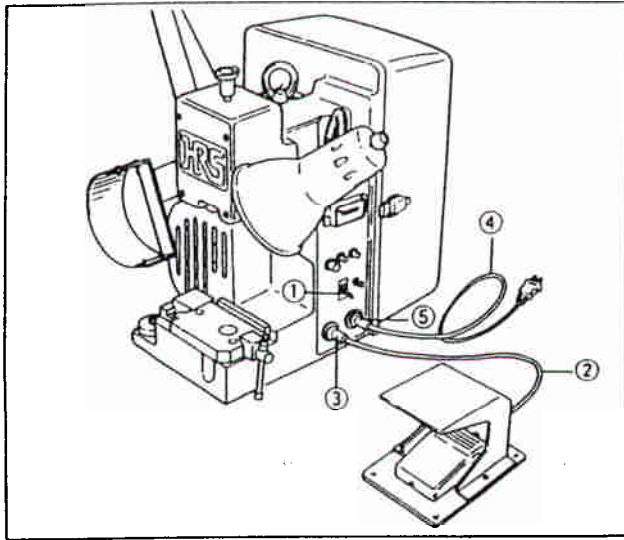

(1) Preparation



CAUTION :

To protect against shock hazards and possible accidents due to abrupt start of the machine, do not power on the machine until you have completed the preparation.

- 1) Check to be sure that the applicator has been detached.
- 2) Make sure that main power switch ① mounted on the right-hand side is in the OFF position.
- 3) Connect foot switch cord ② to metal receptacle ③ (3P).
- 4) Connect power cord ④ to metal receptacle ⑤ (2P).

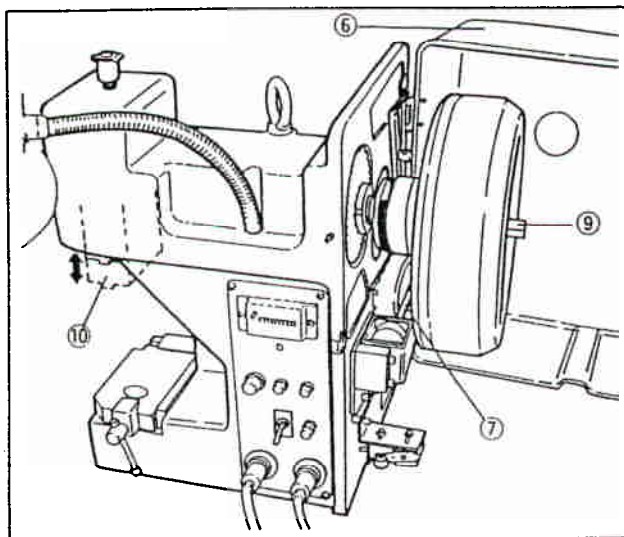

(2) Checking the performance before putting the machine into service



WARNING :

Extreme caution has to be taken not to allow hands, fingers, head and clothing to be involved/ caught in the moving parts of the machine.

- 1) Open flywheel cover ⑥ .
- 2) Press solenoid link ⑦ in the direction of arrow ① to engage the clutch.
- 3) Attach hand-turning handle ⑧ to main shaft ⑨ .
- 4) Turn hand-turning handle ⑧ in the direction of rotation. Simultaneously with the turning of the handle, ram unit ⑩ vertically moves.
- 5) After the vertical motion of ram unit ⑩ is checked, further turn hand-turning handle ⑧ in the direction of rotation until it stops with a "click." This disengages the clutch.
- 6) Remove hand-turning handle ⑧ from main shaft ⑨ .
- 7) After the vertical motion of ram unit ⑩ is checked, close flywheel cover ⑥ . (If flywheel cover ⑥ is opened, the safety switch functions to prevent the motor from starting even if the power switch is set to the ON.)

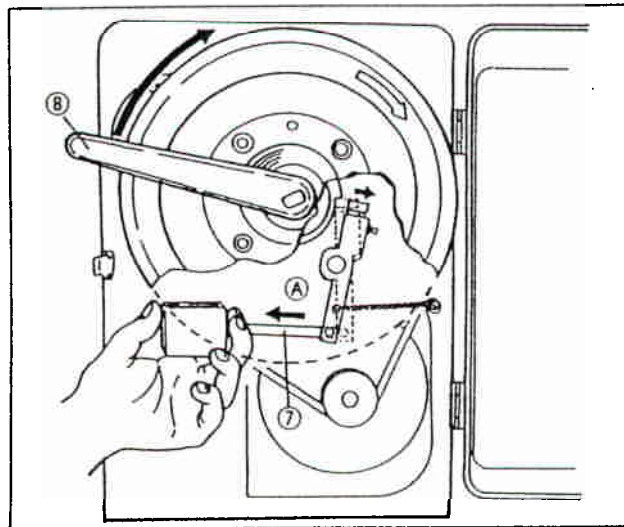

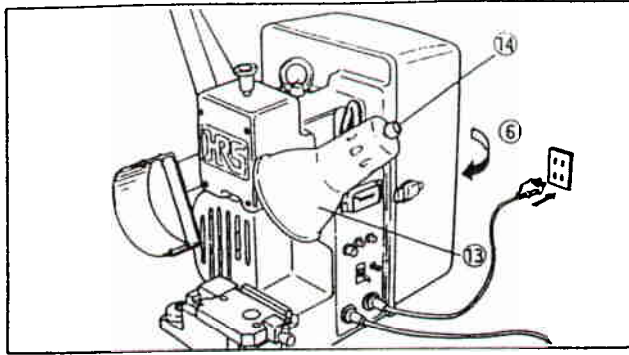

(3) Checking the operation



WARNING :

Extreme caution has to be taken not to allow hands, fingers, head and clothing to be involved/ caught in the moving parts of the machine.

- 1) Connect the plug of power cord ④ to the power supply receptacle.
- 2) Set main power switch ⑪ to the ON position. Power pilot lamp ⑫ lights up. At this time, work light ⑬ lights up and goes out corresponding to ON/OFF of work light switch ⑭.
- 3) Press motor start switch ⑮. This will cause the motor to start. At the same time, motor pilot lamp ⑯ lights up.
- 4) Depress the switch mounted in foot switch ⑰. This will cause ram unit ⑩ to make a vertical travel once. At the same time, counter ⑱ actuates.
- 5) Set main power switch ⑪ to the OFF position, and both power pilot lamp ⑫ and motor pilot lamp ⑯ will go out.

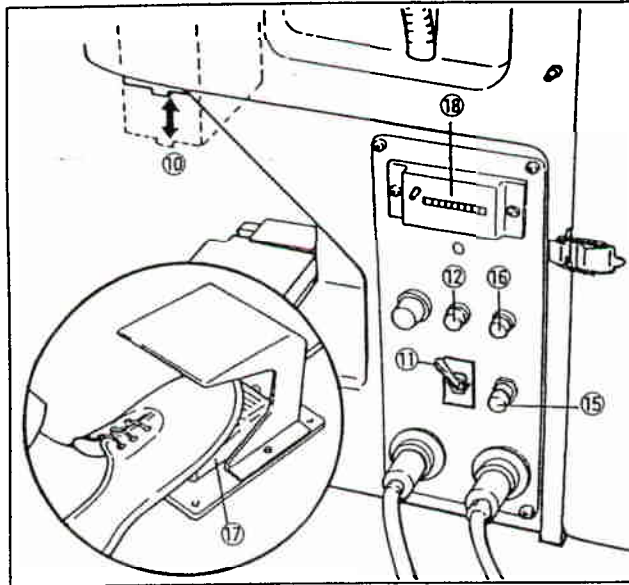

6. ATTACHING/DETACHING THE REEL TERMINAL



CAUTION :

To protect against possible accidents due to abrupt start of the machine, power down the machine before you begin this procedure.

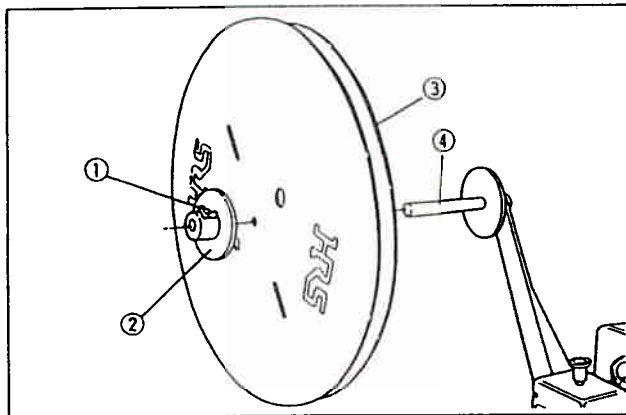

(1) Attaching the reel terminal

- 1) Loosen thumb-screw ①, remove flange ②, and pass reel terminal ③ over reel shaft ④.
- 2) Re-place flange ②, lightly press it and re-tighten thumb-screw ① to the correct position.

(Caution) Refer to the instruction manual for your applicable applicator for details.

(2) Detaching the reel terminal

- 1) Detach the reel terminal following the same procedure as that taken to attach it.

7. ATTACHING/DETACHING THE APPLICATOR



CAUTION :

To protect against possible accidents due to abrupt start of the machine, power down the machine before starting this procedure.

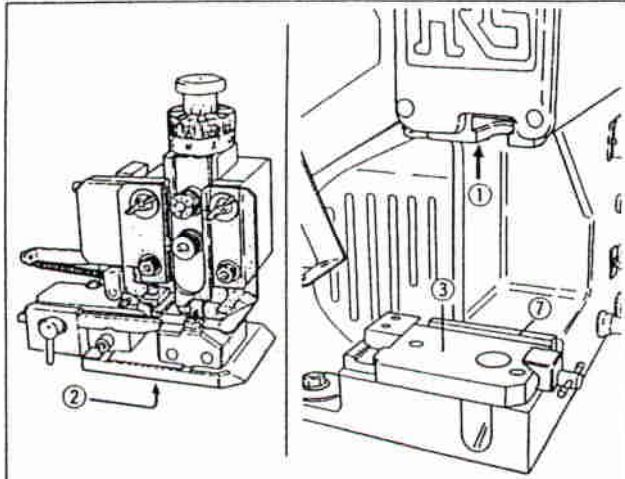

(1) Attaching the applicator

- 1) Turn the power off.
- 2) To attach the applicator, be sure to check the performance before putting the machine into service (refer to "5-(2) Checking the performance before putting the machine into service") to ascertain that the ram is in its top dead center ①.
- 3) Thoroughly remove dust and stains from bottom face ② of the applicator base and top face (contact plane) ③ of the bolster plate.

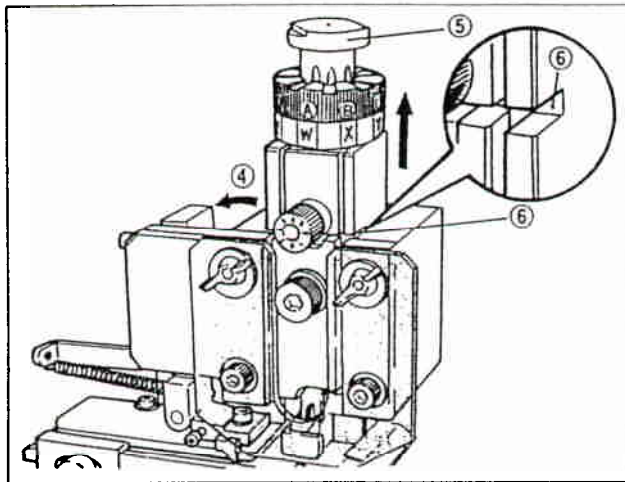

- 4) Keeping terminal feed lever ④ held tilted in the direction of the arrow, lift shank ⑤ (do not draw it out) to fit it in slit ⑥ on the main unit.

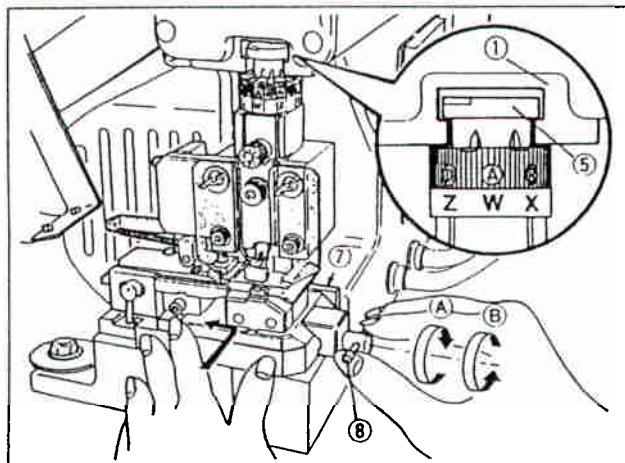

- 5) Place the applicator on the top face of bolster plate ③ and slide it forward until it is pressed against stopper block ⑦.
- 6) Press clamp lever ⑧ in the direction of arrow ① until it is secured.
At this time, make sure that shank ⑤ is attaching on ram ①.

(Caution) This completes the installation of the applicator. Never carry out a crimp, in this state, with no material loaded.

(2) Detaching the applicator

- 1) Loosen clamp lever ⑧ by turning it in the direction of arrow ② and pull the applicator until it comes off.

8. MAINTENANCE

CAUTION :



1. To prevent possible accidents, repair and adjustment of the machine shall be conducted only by trained maintenance personnel. Any repair and adjustment beyond the specifications covered in this Instruction Manual is prohibited. We assume no responsibility for accidents caused by improper repair or adjustment including the use of non-genuine part(s).
2. To protect against possible accidents and electric shock hazards, repair and maintenance work (including wiring) of electrical parts should be conducted by electrical technicians or HIROSE engineers. In the event that electrical parts need repair or maintenance, please consult any of the aforementioned persons.

(1) Lubrication



CAUTION :

To protect against possible accidents due to abrupt start of the machine, power down the machine before.

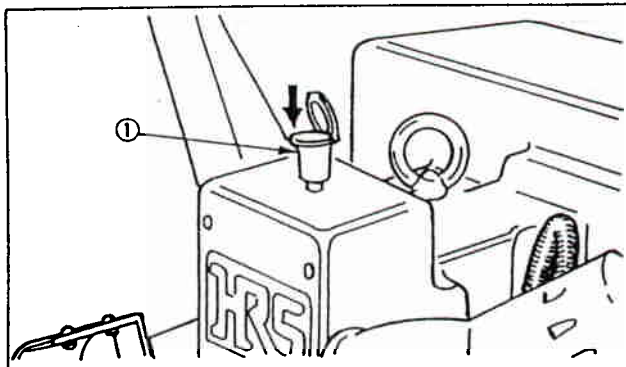

(1)-1. Sliding section of the ram

- 1) Once a week, apply four or five drops of oil in oil cup ① on the top of the machine.

Designated oil = ISO VG32

(Caution) Avoid excessive oiling.

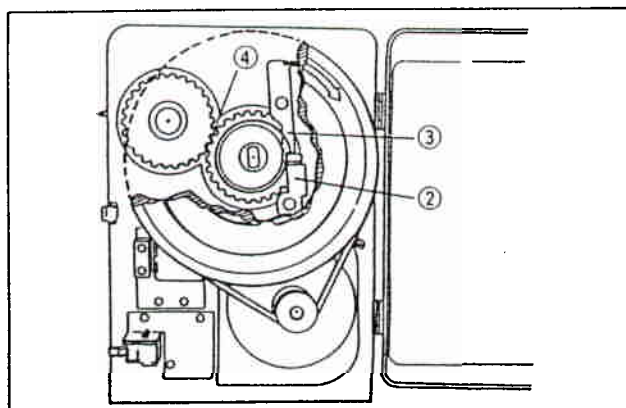

(1)-2. Sliding section of the clutch unit

- 1) Once a month, apply grease lightly on clutch claw ②, back-stop claw ③ and surrounding area.
- 2) Once every six month, apply 2 to 3 cc of grease to helical gear ④.

Designated grease = Grease for centralized lubrication NLGI 2

(Caution) Avoid excessive greasing.

(2) Inspection

WARNING :



1. Extreme caution has to be taken not to allow hands, fingers, head, hair or clothing to be caught in the moving parts of the machine and V-belt.
2. To protect against possible accidents due to abrupt start of the machine, power down the machine before starting this procedure.

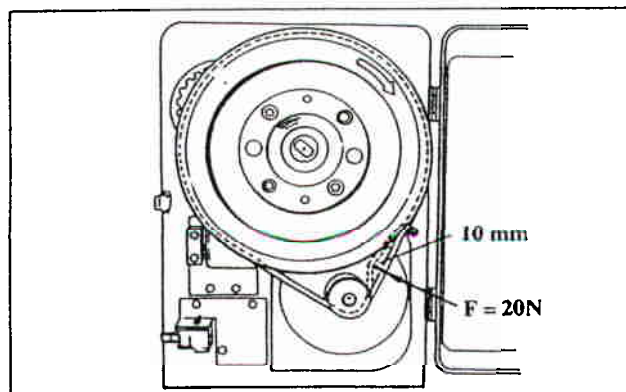

(2)-1. Checking the V-belt for damage and slack

- 1) Check to be sure that the V-belt has no abnormal scratches and stains.
- 2) With respect to the degree of slack, make sure that the V-belt sags approximately 10 mm in the direction of the arrow when a 20 N load is applied.

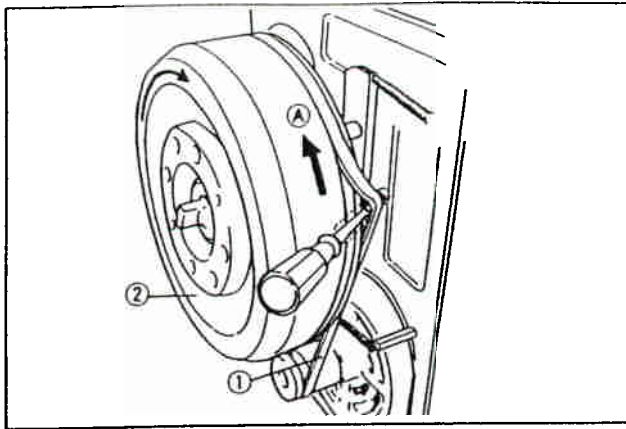

(2)-2. Replacing the V-belt

* Detaching the V-belt

- 1) Hold V-belt ① with a screwdriver to allow V-belt to come off the slit on flywheel ②.
- 2) Now, carefully turn flywheel ② in the direction of arrow ④ until the V-belt comes off.

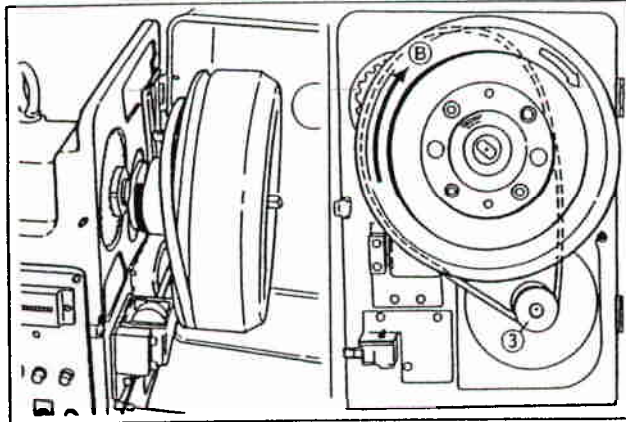

* Attaching the V-belt

- 1) Pass V-belt ① inside flywheel ②.
- 2) Fit the V-belt in the slit on motor pulley ③.
- 3) Then, pressing V-belt ① against the slit on flywheel ②, carefully turn flywheel ② in the direction of arrow ④ until the V-belt fits in the slot.

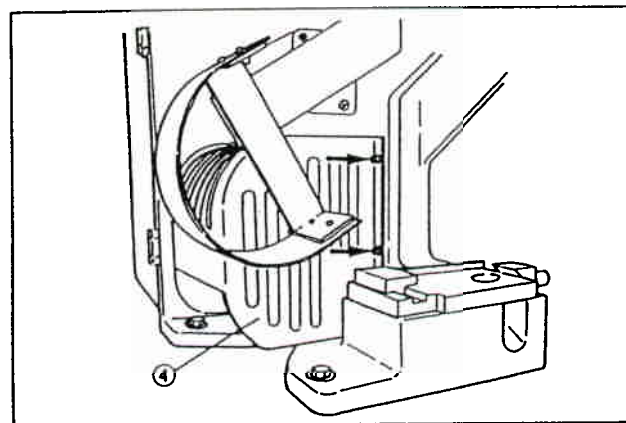

(2)-3. How to adjust the slack of the V-belt

Adjust the slack of V-belt ① by changing the installing position of motor ⑤ up or down.

- 1) Remove two mounting screws (M4) from motor cover ④.
- 2) Loosen four bolts (M5) used to mount motor ⑤ to such an extent that allows the motor ⑤ to move. (If these bolts are excessively loosened in this step, motor ⑤ will drop by gravity. Make a cushion with a shop cloth and place it in the space provided by lifting motor ⑤ to avoid hands and fingers being caught in the space.)
- 3) While in this position, move the mounting position of motor ⑤ up or down while checking the extent of slack of V-belt ①.
- 4) Tighten four bolts (M5) to fit the motor to a position that allows the V-belt to slack appropriately. (Re-check the slack of V-belt ①. Tightening the bolts can change the slack of the V-belt.)
- 5) Finally, attach motor cover ④ in position.

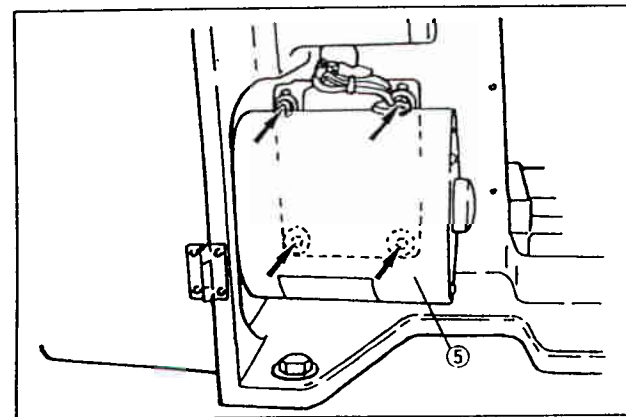

9. TROUBLESHOOTING

Before troubleshooting, the following has to be checked.

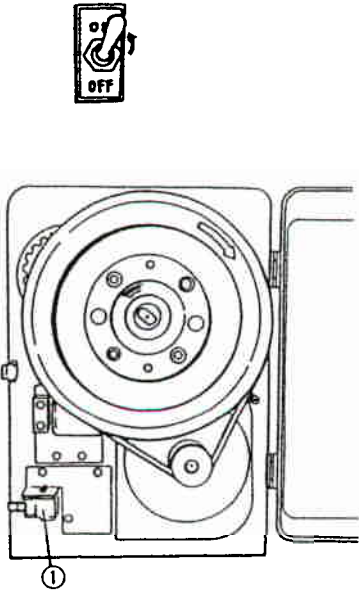
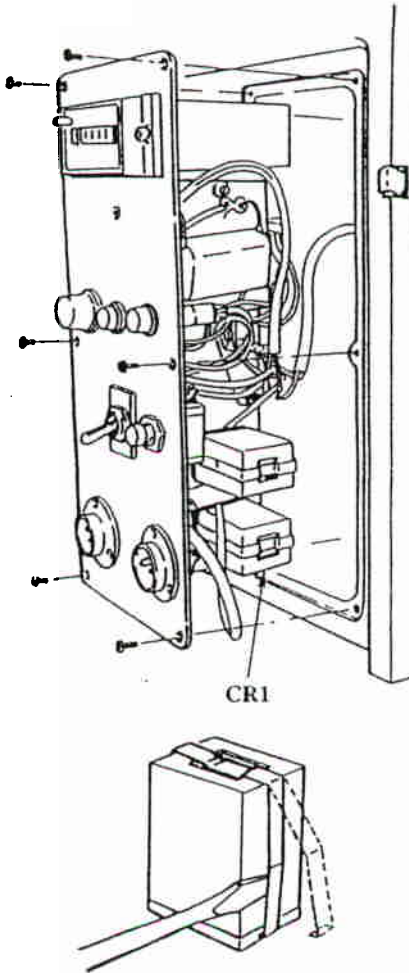

- 1) Is the power plug connected to a 100 V power supply receptacle?
- 2) Has the fuse blown?
- 3) Are connectors fitted properly? (Power cord, foot switch cord, inside the electrical box)
- 4) Is the flywheel cover correctly closed?

Trouble	Cause	Corrective measure
<p>1. The motor fails to move even when the motor start switch is pressed.</p> 	<ol style="list-style-type: none"> 1. Installing position of safety switch ①, mounted inside the flywheel cover, is wrong. This would prevent the switch from turning on. 2. Relay (CR1) is not correctly set (it is raised) or, it fails to operate normally. 	<div style="border: 1px solid black; padding: 5px; margin-bottom: 10px;"> <p>⚠ DANGER : To protect against shock hazards, open the cover, if necessary, after turning the power off and waiting a minimum of five minutes.</p> </div> <ol style="list-style-type: none"> 1. Properly close the flywheel cover. Move safety switch ① to such a position that the switch turns on and fix the switch there. 2. Properly set the relay (CR1) or replace it with a new one. 

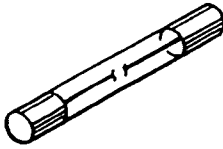
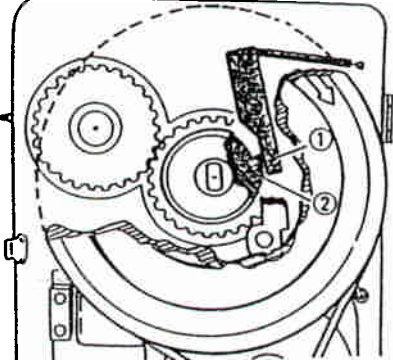
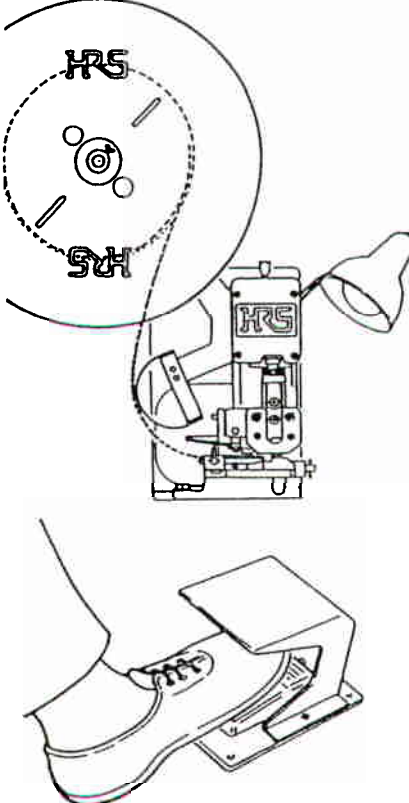
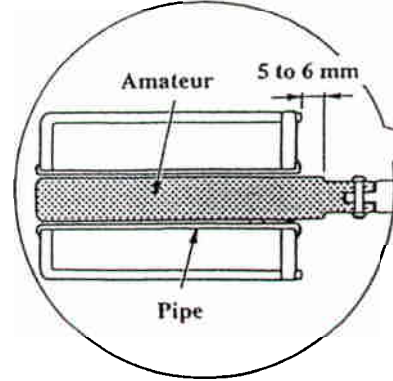
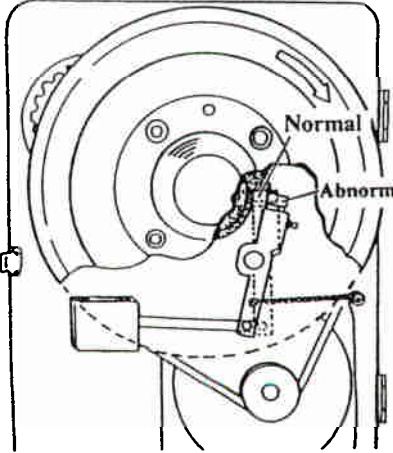
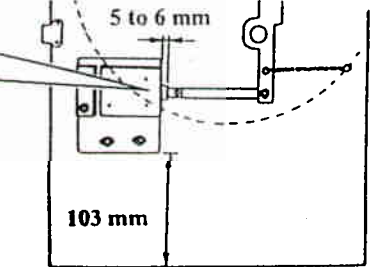
Contact our Production Engineering Department with any questions regarding trouble other than those described in this section.

Trouble	Cause	Corrective measure
<p>2. Fuse frequently blows when the motor starts.</p> 	<p>1. The clutch is not properly engaged. Back-stop lever ① fails to engage with back-stop cam ②.</p> 	<div style="border: 1px solid black; padding: 5px;"> <p>WARNING : Extreme caution has to be taken not to allow hands, fingers, head and clothing to be caught in the moving parts of the machine.</p> </div> <p>1. Adjust to engage the clutch properly according to "5-(2) Checking the performance before putting the machine into service."</p>
<p>3. The crimping machine fails to operate even when the foot switch is depressed.</p> 	<p>1. The V-belt is not installed.</p> <p>2. The stop position of the clutch stopper is not normal.</p>  	<div style="border: 1px solid black; padding: 5px;"> <p>WARNING : Extreme caution has to be taken not to allow hands, fingers, head and clothing to be involved/caught in the moving parts of the machine.</p> </div> <p>1. Install the belt according to "8-(2)-2. Attaching the V-belt."</p> <p>2-1. The solenoid may be improperly positioned. Check the installing position of the DC solenoid bracket and adjust it, if necessary.</p>  <p>2-2. Dust or other particles may gather in the gap existing between the amateur of the DC solenoid and the pipe. This can cause suction force to be inconsistent. Remove the DC solenoid and wipe it clean with a piece of cloth or the like. The same difficulty can also arise in the event that the DC solenoid has deteriorated with time. If the clutch stopper stop position cannot be corrected by removing the foreign matter, replace the DC solenoid valve with a new one.</p>

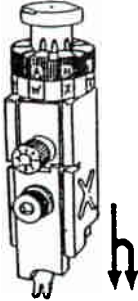
Contact our Production Engineering Department with any or questions regarding any trouble other than those described in this section.

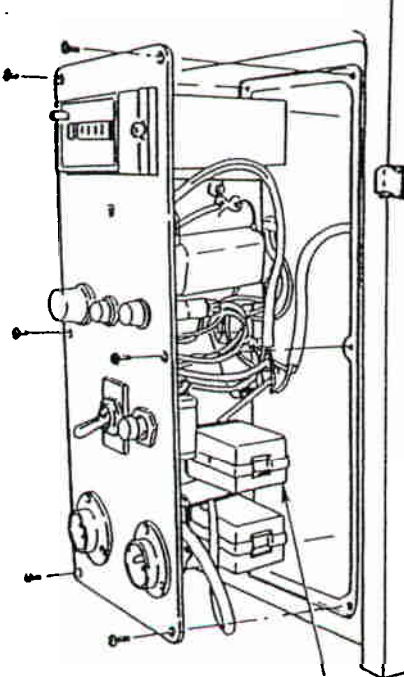
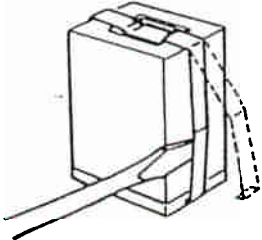
Trouble	Cause	Corrective measure
<p data-bbox="188 317 594 426">4. Double-placement or successive-placement is sometimes performed during crimping operations.</p> 	<p data-bbox="621 310 987 338">1. Malfunction of the foot switch.</p> <p data-bbox="621 611 1027 674">2. Contact of the relay (CR2) has welded.</p>	<div data-bbox="1052 96 1458 289" style="border: 1px solid black; padding: 5px;">  <p data-bbox="1179 107 1325 134">DANGER :</p> <p data-bbox="1068 138 1450 285">To protect against shock hazards, open the cover, if necessary, after turning the power off and waiting for a minimum of five minutes or more.</p> </div> <p data-bbox="1052 310 1458 499">1-1. Remove the applicator. Then, depress the foot switch securely approximately 100 times to determine whether the foot switch has failed or not.</p> <p data-bbox="1052 520 1458 583">1-2. Conduct proper training of the operator.</p> <p data-bbox="1052 604 1458 667">2. Replace the relay (CR2) with a new one.</p>  <p data-bbox="1357 1409 1406 1436">CR2</p> 

Contact our Production Engineering Department with any or questions with regarding trouble other than those described in this section.

10. APPENDIX

(1) Electric wiring diagram

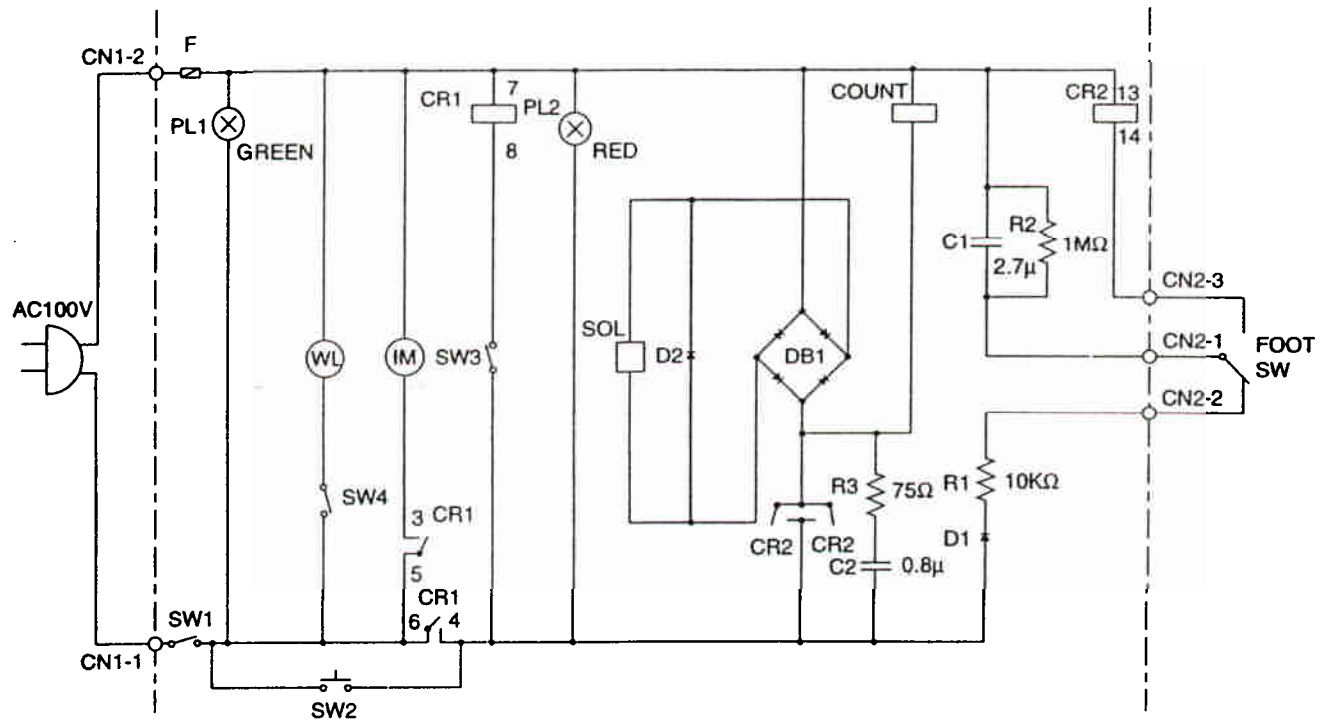

Symbol	Name of product	Model
CN1	Connector (2P)	Hirose Electric Co.
CN2	Connector (3P)	Hirose Electric Co.
F	Fuse (10 A)	-
SW1	Main power switch	Matsushita Electric Industrial Co., Ltd. WD-1011
SW2	Motor start switch	Miyama DS-133
SW3	Safety switch	Omron TYPE-AP-A
SW4	Light switch	-
FOOT SW	Foot switch	-
PL1	Power pilot lamp	Maruyasu 103 GS
PL2	Motor pilot lamp	Maruyasu 103 RS
WL	Work light (40 W)	-
IM	Motor (200 W)	Matsushita Electric Industrial Co., Ltd. ES-DBF 100 V 200 W
CR1	Relay	Omron MY-2
CR2	Relay	Omron LY-2
SOL	DC solenoid	Act Giken SD12-AA-48-00T
COUNT	Counter	Tamura E610-PP15

(2) Major component names

Item	Product name	Product number	Q'ty	Item	Product name	Product number	Q'ty
1	Frame	276224	1	41	Retaining pin	276264	2
2	Eye bolt	276225	1	42	Release lever spring	276265	1
3	Oil cup	276226	1	43	Solenoid link	276266	1
4	Front cover	276227	1	44	DC solenoid	276267	1
5	Ram	276228	1	45	DC solenoid bracket	276268	1
6	Slide block	276229	1	46	Solenoid stopper	276269	1
7	Needle bearing	276230	1	47	Spring hanger	276270	1
8	Crank shaft	276231	1	48	Stud bolt (B)	276271	1
9	Crank shaft key	276232	1	49	Back-stop lever	276272	1
10	Retaining ring (A)	276233	2	50	Back-stop spring	276273	1
11	Ball bearing	276234	2	51	Spring pin	276274	2
12	Retaining ring (B)	276235	2	52	Safety switch	276275	1
13	Helical gear	276236	2	53	Safety switch bracket	276276	1
14	Bearing washer	276237	2	54	Collar	276277	3
15	Nut	276238	2	55	Bolster plate	276278	1
16	Cover	276239	1	56	Stopper block	276279	1
17	Retaining ring (C)	276240	1	57	Clamp (A)	276280	1
18	Retaining ring (D)	276241	3	58	Clamp (B)	276281	1
19	Ball bearing	276242	3	59	Clamp spring	276282	1
20	Main shaft	276243	1	60	Clamp bolt	276283	1
21	Main shaft key	276244	1	61	Clamp lever	276284	1
22	Back-stop cam	276245	1	62	Reel support	276285	1
23	Spring post	276246	2	63	Reel shaft	276286	1
24	Clutch wheel	276247	1	64	Flange (A)	276287	1
25	Clutch spring	276248	1	65	Flange (B)	276288	1
26	Clutch roller	276249	7	66	Terminal guide bracket	276289	1
27	Clutch cage	276250	1	67	Terminal guide	276290	1
28	Outer race	276251	1	68	Flywheel cover	276291	1
29	Spring pin	276252	2	69	Hinge	276292	2
30	Flywheel	276253	1	70	Reel cover hook	276293	1
31	V-belt	276254	1	71	Grease nipple	276294	1
32	Motor pulley	276255	1	72	Noise absorbing	276295	1
33	Flywheel collar	276256	1	73	Power cord	276296	1
34	Release lever	276257	1	74	Foot switch	276297	1
35	Clutch stopper	276258	1	75	Work light	276298	1
36	Pad	276259	1	76	Counter	276299	1
37	Stud bolt	276260	1	77	Electrical box	276300	1
38	Spring hanger	276261	2	78	Motor cover	276301	1
39	Stop ring	276262	2	79	Motor	276302	1
40	Link pin	276263	1	80	Handle	276303	1

Main unit of crimping machine Model CM-105

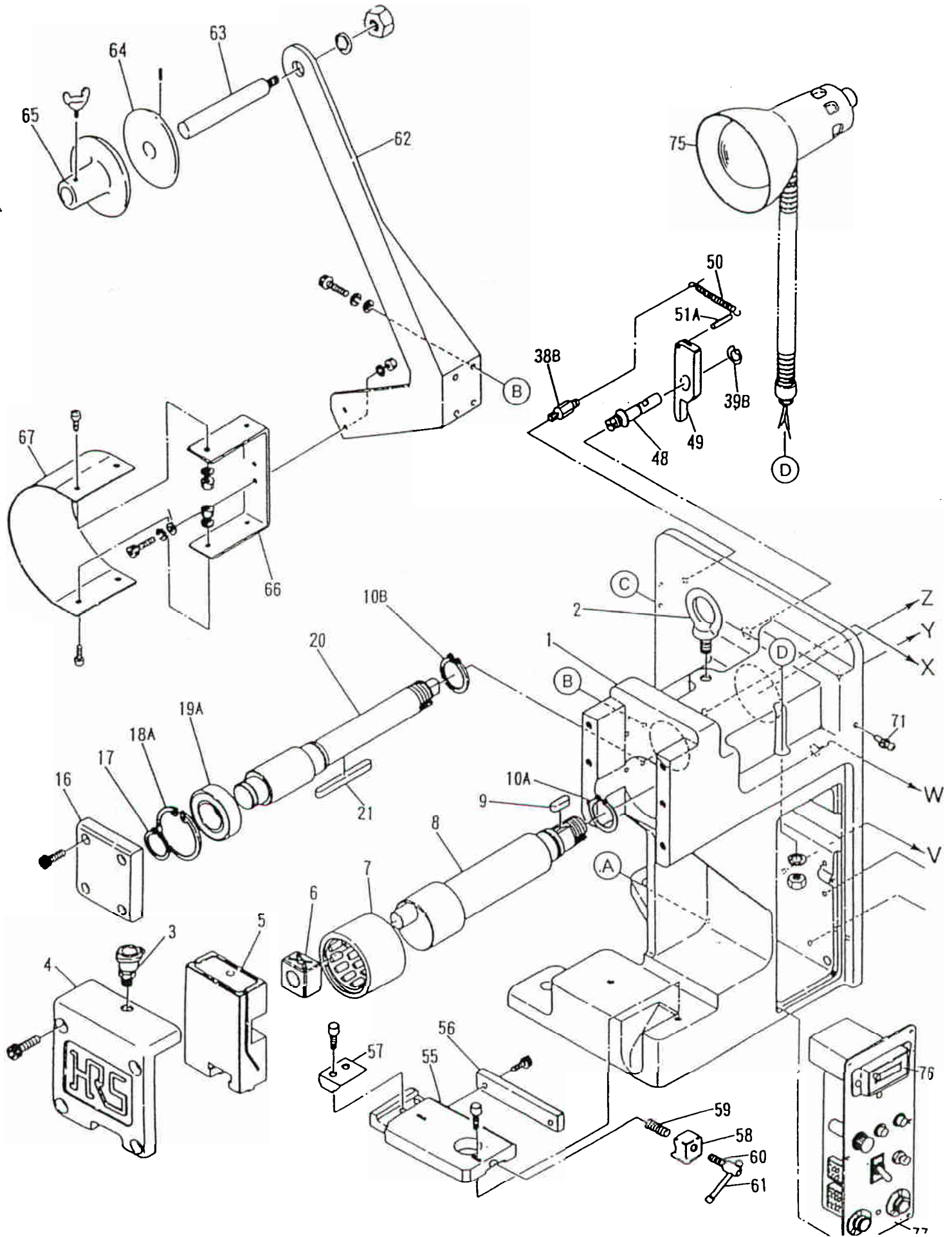

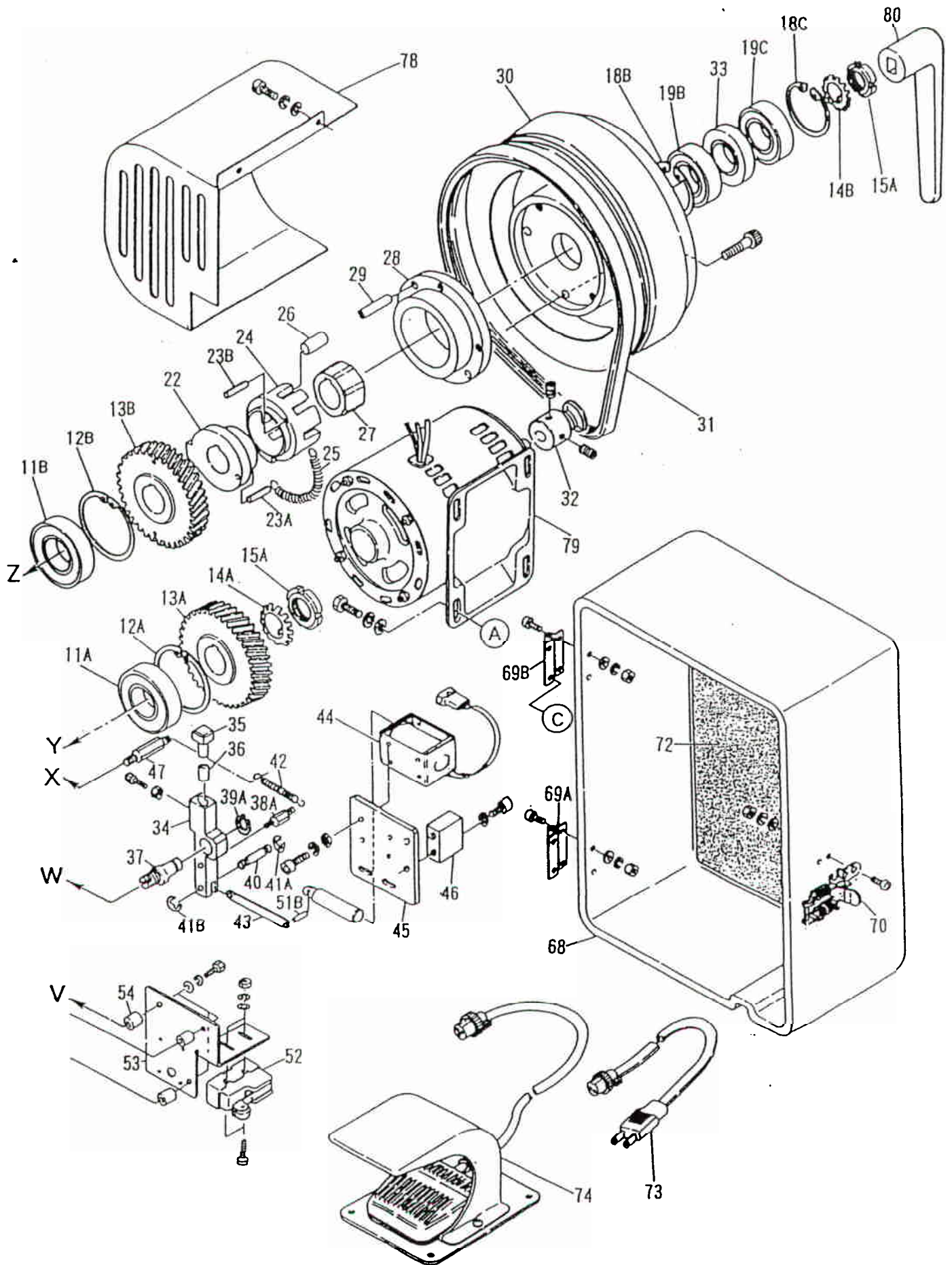

TAD-P0510	
Date of issue	June 1997
Date of revision	
Edition number	First edition

CAUTION

- (1) No part of this manual may be reproduced without the permission of Hirose Electric Co., Ltd.
- (2) Description in this manual is subject to change without notice.
- (3) This Instruction Manual has been prepared for clarify. Should you find any unclear portion, error, or omission, please, for the safety of other, contact our Marketing Department.
- (4) It should be understood that, notwithstanding the aforementioned item (3), we assume no liability to any claim for loss or failure to earn profit resulting from the use of the machine.
- (5) We assume no responsibility for any damage resulting from your improper use of the machine including your failure to follow the instructions given in this Instruction Manual. This includes repair or modification conducted by any third party other than Hirose Electric Co., Ltd.
- (6) Please note that servicing of the machine is not available in any country other than Japan.