

Click to
ORDER
samples

AMEOF8-277NZ

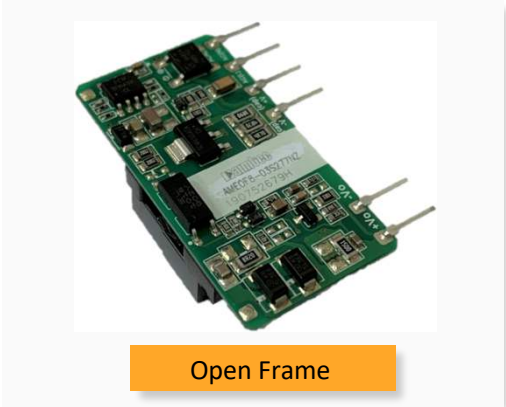

Open Frame

AMEOF8-277NZ series is one of Aimtec highly efficient green 8W AC-DC converters. They feature a wide input voltage range of 85-305VAC, high efficiency up to 79%, low power consumption and CLASS II reinforced insulation. The large variety of EMC external circuits meet the needs of multiple industries. This new series offers great operating temperatures, from -40°C to 85°C and an isolation of 3000VAC for improved reliability and system safety. Furthermore, a high MTBF of 300,000h, output short circuit protection (OSCP), output over-current protection (OCP) and an output over-voltage protection (OVP) come standard with the series. All models are suitable for industrial controls, instrumentation and smart home applications with size constraints.

Features

- Universal Input: 85 - 305VAC/100 - 430VDC
- Operating Temp: -40 °C to +85 °C
- High isolation voltage: 3000VAC
- Low ripple & noise, 150mV(p-p), max.
- Output short circuit, over-current protection
- Open frame package

Summary

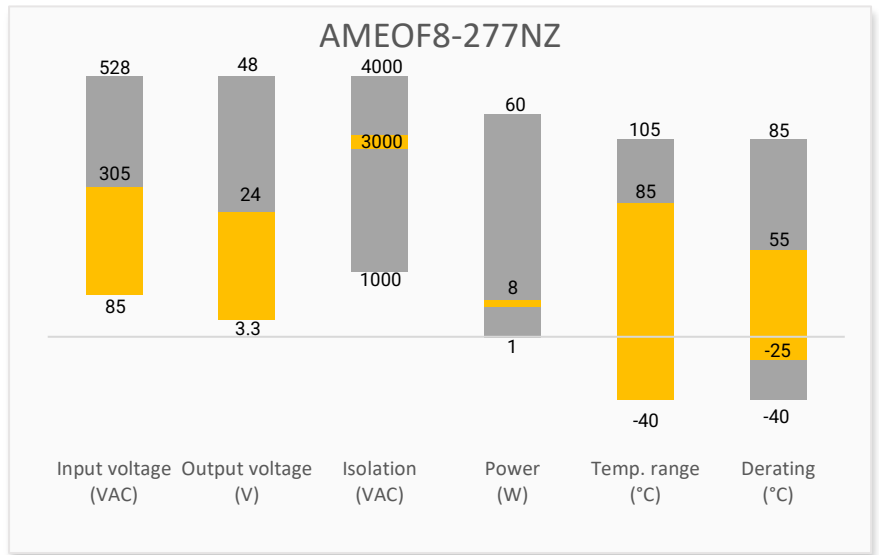

Training

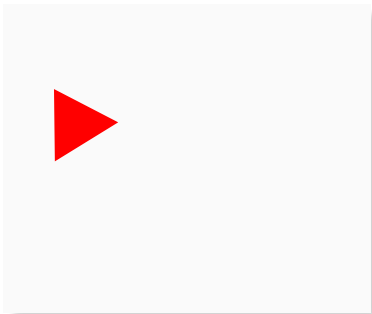

Product Training Video
(click to open)



Application Notes

Applications



Power Grid

Industrial

Telecom

Instrumentation

Models & Specifications

Single Output Straight Pins

Model	Input Voltage (VAC/Hz)	Input Voltage (VDC)	Max Output wattage (W)	Output Voltage (V)	Output Current max (A)	Maximum capacitive load (μ F)	Efficiency @ 230VAC (%)
AMEOF8-03S277NZ	85~305/47~63	100~430	5.28	3.3	1.60	1500	70
AMEOF8-05S277NZ	85~305/47~63	100~430	8	5	1.60	1500	74
AMEOF8-09S277NZ	85~305/47~63	100~430	8	9	0.88	1000	75
AMEOF8-12S277NZ	85~305/47~63	100~430	8	12	0.67	680	76
AMEOF8-15S277NZ	85~305/47~63	100~430	8	15	0.53	470	77
AMEOF8-24S277NZ	85~305/47~63	100~430	8	24	0.33	330	79

Single Output Bended Pins

Model	Input Voltage (VAC/Hz)	Input Voltage (VDC)	Max Output wattage (W)	Output Voltage (V)	Output Current max (A)	Maximum capacitive load (μ F)	Efficiency @ 230VAC (%)
AMEOF8-03SL277NZ	85~305/47~63	100~430	5.28	3.3	1.60	1500	70
AMEOF8-05SL277NZ	85~305/47~63	100~430	8	5	1.60	1500	74
AMEOF8-09SL277NZ	85~305/47~63	100~430	8	9	0.88	1000	75
AMEOF8-12SL277NZ	85~305/47~63	100~430	8	12	0.67	680	76
AMEOF8-15SL277NZ	85~305/47~63	100~430	8	15	0.53	470	77
AMEOF8-24SL277NZ	85~305/47~63	100~430	8	24	0.33	330	79

Input Specifications

Parameters	Conditions	Typical	Maximum	Units
Input Current	115VAC		300	mA
	277VAC		150	mA
Inrush current	115VAC	15		A
	277VAC	30		A
External fuse	Slow blow type	1		A

Output Specifications

Parameters	Conditions	Typical	Maximum	Units
Voltage accuracy	Full load, 3.3V output	± 1.5	± 3	%
	Full load, Others	± 1	± 2	%
Line regulation	Full load	± 0.5	± 1	%
Load regulation	0-100% load	± 1	± 1.5	%
Ripple & Noise	20MHz bandwidth	80	150	mV p-p

Isolation Specifications

Parameters	Conditions	Typical	Rated	Units
Tested I/O voltage	60 sec, 5mA max		3000	VAC

General Specifications				
Parameters	Conditions	Typical	Maximum	Units
Switching frequency		65-110		Khz
Protection class		Class II		
Over Current protection	Auto recovery	≥ 110		% of Iout
Short circuit protection		Hiccup, Continuous, Auto recovery		
Operating temperature		-40 to +85		°C
Storage temperature		-40 to +105		°C
Temperature coefficient		±0.02		% / °C
Power derating	-40 °C to -25 °C	2.67		% / °C
	+55 °C to +85 °C	2.5		% / °C
	85VAC ~ 100VAC	1		% / VAC
	277VAC ~ 305VAC	0.54		% / VAC
Cooling		Free air convection		
Storage Humidity			95	% RH
Weight		11		g
Dimensions (L x W x H)		1.75 x 0.94 x 0.59 inches (44.50 x 24.00 x 15.00mm)		
MTBF		> 300 000 hrs (MIL-HDBK -217F, t=+25°C)/Full Load		
NOTE: All specifications in this datasheet are measured at an ambient temperature of 25°C, humidity<75%, nominal input voltage and at rated output load unless otherwise specified.				

Safety Specifications		
Parameters		
Agency approvals	UL 62368-1	
	Design to meet EN60335 / EN62368	
Standards	EMC - Conducted and radiated emission	CISPR32 / EN55032, Class A, (With EMI Class A circuit) CISPR32 / EN55032, Class B, (With EMI Class B circuit)
	Electrostatic Discharge Immunity	IEC 61000-4-2 Contact ±6KV, Criteria B
	RF, Electromagnetic Field Immunity	IEC 61000-4-3 10V/m, Criteria A
	Electrical Fast Transient/Burst Immunity	IEC 61000-4-4 ±2KV, Criteria B, (With EMS Class III circuit) IEC 61000-4-4 ±4KV, Criteria B, (With EMS Class IV circuit)
	Surge Immunity	IEC 61000-4-5 L-L ±1KV, Criteria B, (With EMS Class III circuit) IEC 61000-4-5 L-L ±2KV, Criteria B, (With EMS Class IV circuit) IEC 61000-4-5 L-L ±4KV, Criteria B, (With EFT Class IV, Surge L-G ±4KV circuit)
	RF, Conducted Disturbance Immunity	IEC 61000-4-6 10Vr.m.s, Criteria A
	Voltage dips, Short Interruptions Immunity	IEC 61000-4-11 0%, 70%, Criteria B

Derating 

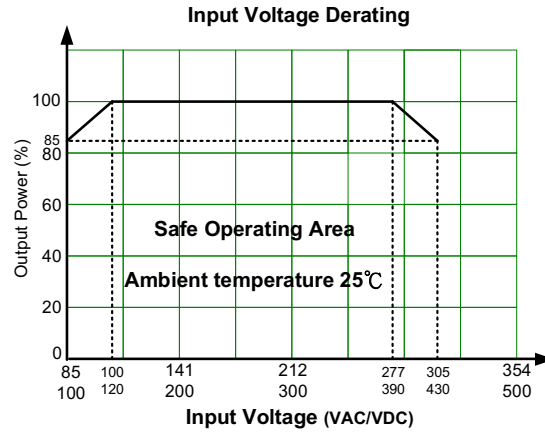
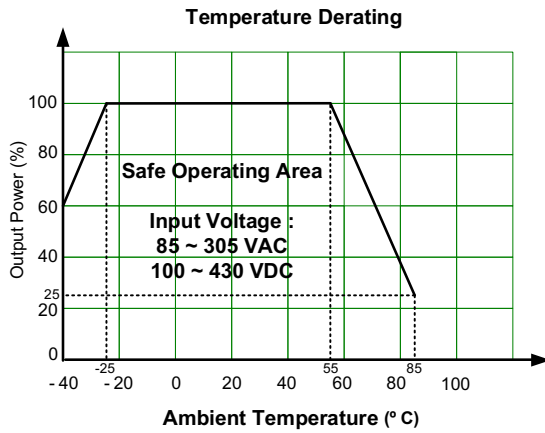

Dimensions

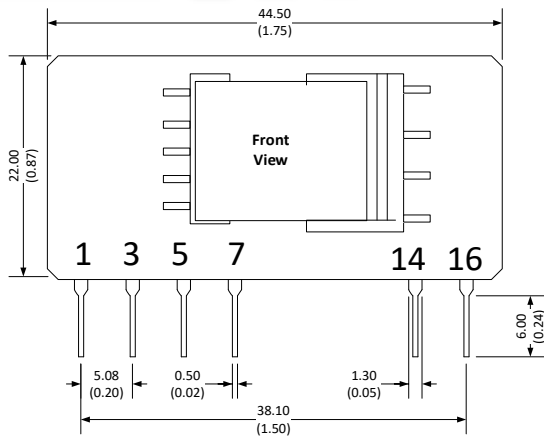

Note:
Unit: mm [inch]
Pin section tolerances: ± 0.10 [± 0.004]
General tolerances: ± 0.50 [± 0.020]

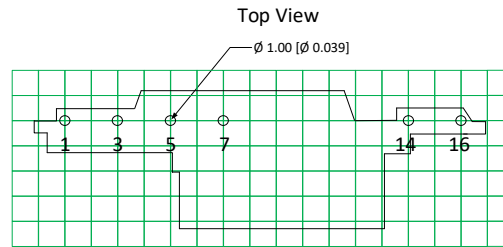
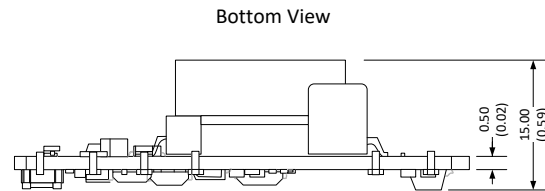

L Model Dimensions

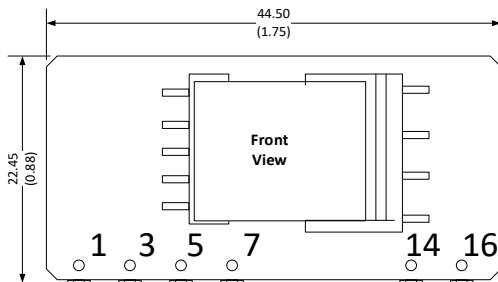

Note:
Unit: mm [inch]
Pin section tolerances: ± 0.10 [± 0.004]
General tolerances: ± 0.50 [± 0.020]

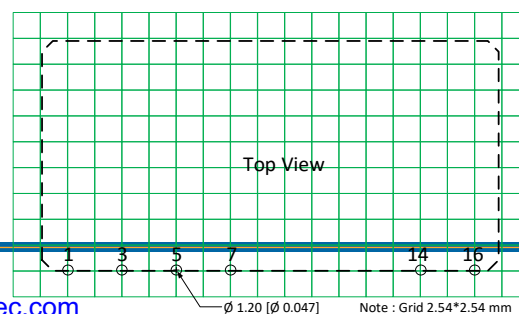
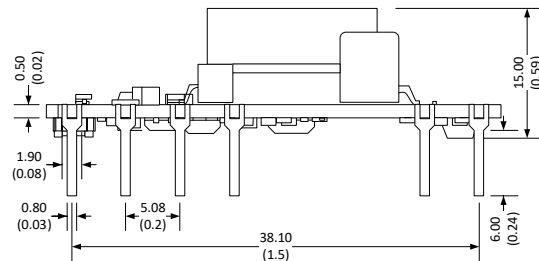

Pin Output Specifications	
Pin	Function
1	AC Input (N)
3	AC Input (L)
5	+V_Cap
7	-V_Cap
14	-V Output
16	+V Output

Note:

1. Capacitor between pin5 and pin7 is necessary.
2. External circuit on the output side is necessary. Please refer to the recommended circuit.
3. It is needed to have distance $\geq 6.4\text{mm}$ for safety between external components in primary circuit and secondary circuit.
4. The layout of the device is for reference only, please refer to the actual product.

Recommended EMC external circuit

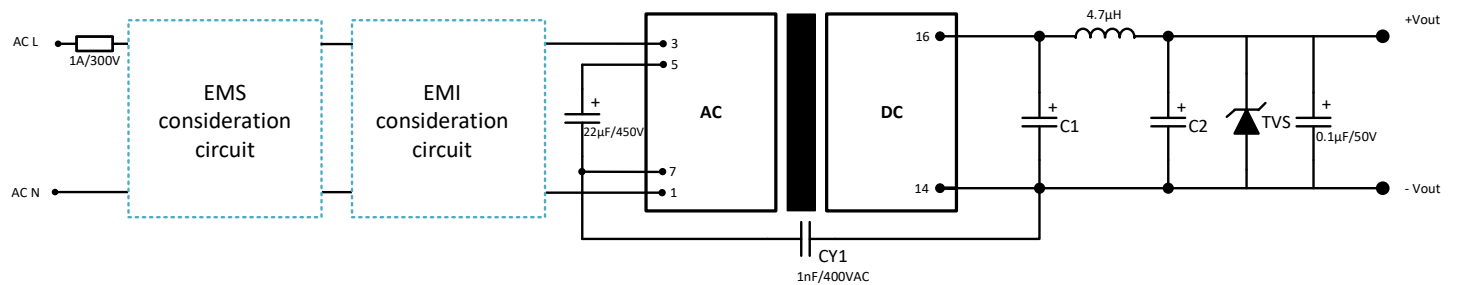

A suppressor diode (TVS) with 1.2 times of the output voltage rating is recommended.

EMI & EMS Recommended Circuit

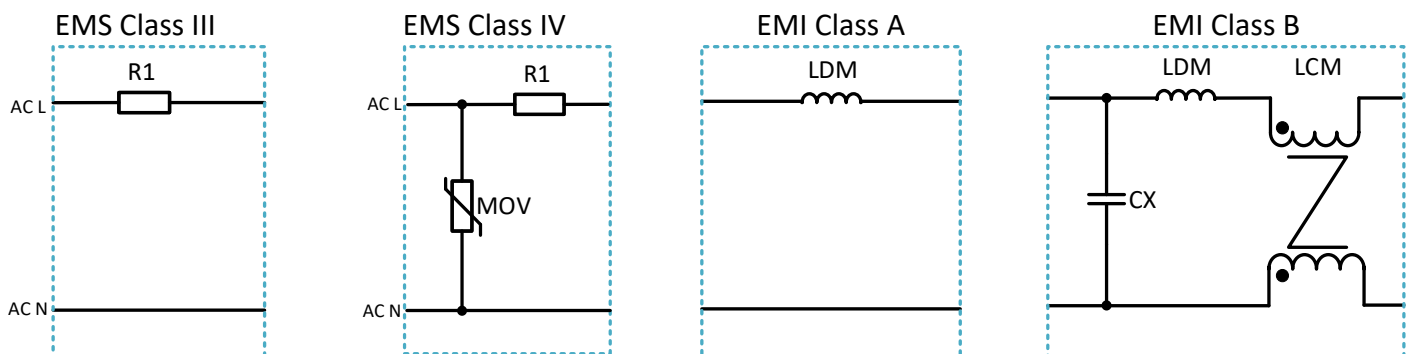

Component	EMS		EMI	
	Class III	Class IV	CLASS A	CLASS B
MOV	-	S14K350	-	-
R1	12Ω/3W	12Ω/3W	-	-
CX	-	-	-	0.1μF/310VAC

LCM	-	-	-	3.5mH
LDM	-	-	4.7mH	0.33mH
FUSE	1A/300V	2A/300V	1A/300V	1A/300V

Model name	C1	C2
3.3 VDC output	470 μ F/16V (Solid capacitor)	150 μ F/35V
5 VDC output	470 μ F/16V (Solid capacitor)	150 μ F/35V
9 VDC output	220 μ F/16V (Solid capacitor)	100 μ F/35V
12 VDC output	220 μ F/16V (Solid capacitor)	100 μ F/35V
15 VDC output	470 μ F/35V	47 μ F/35V
24 VDC output	220 μ F/35V	47 μ F/35V

Recommended EMC circuit for EN60335

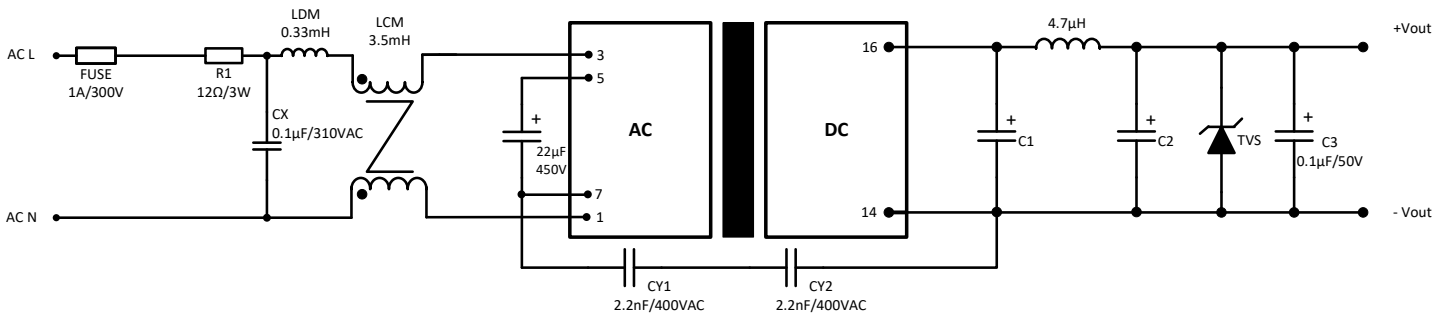

Recommended EMC circuit for EMI Class B, EMS Class IV

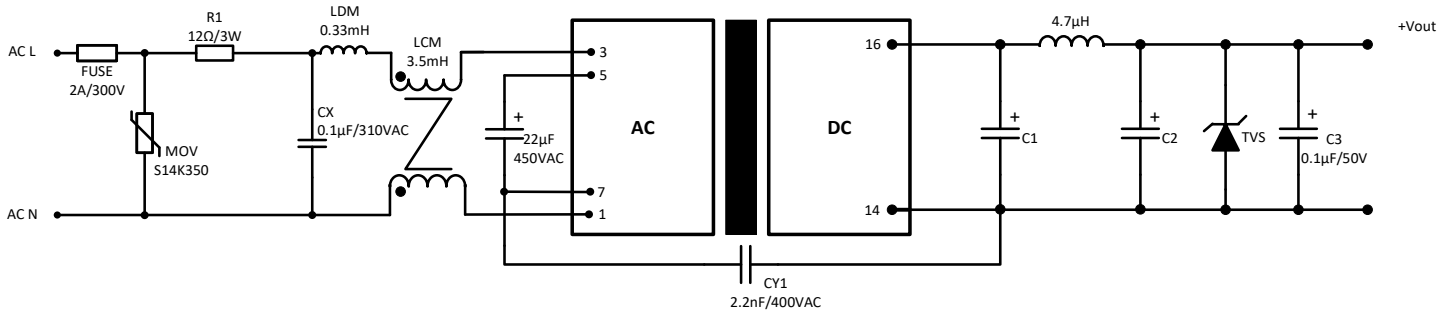

Recommended EMC circuit for EFT Class IV, Surge L-G ±4KV

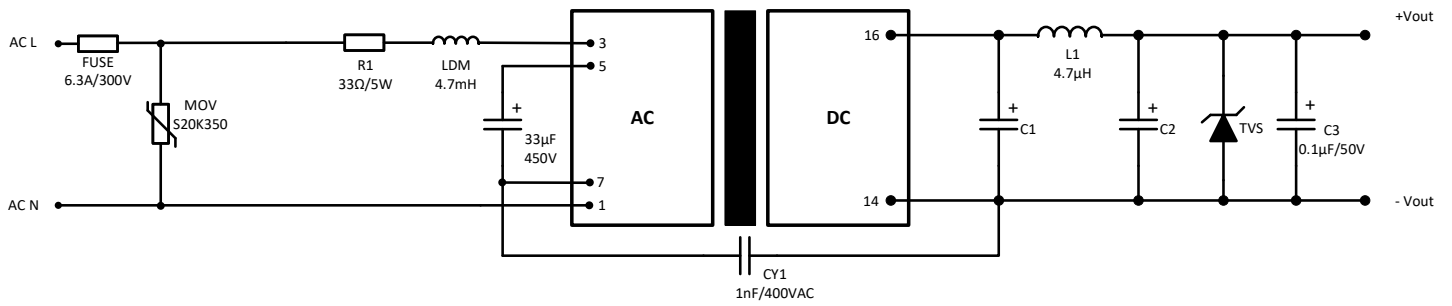

NOTE: **1.** Datasheets are updated as needed and as such, specifications are subject to change without notice. Once printed or downloaded, datasheets are no longer controlled by Aimtec; refer to www.aimtec.com for the most current product specifications. **2.** Product labels shown, including safety agency certifications on labels, may vary based on the date manufactured. **3.** Mechanical drawings and specifications are for reference only. **4.** All specifications are measured at an ambient temperature of 25°C, humidity<75%, nominal input voltage and at rated output load unless otherwise specified. **5.** Aimtec may not have conducted destructive testing or chemical analysis on all internal components and chemicals at the time of publishing this document. CAS numbers and other limited information are considered proprietary and may not be available for release. **6.** This product is not designed for use in critical life support systems, equipment used in hazardous environments, nuclear control systems or other such applications which necessitate specific safety and regulatory standards other the ones listed in this datasheet. **7.** Warranty is in accordance with Aimtec's standard Terms of Sale available at www.aimtec.com.