



# 622Mbps, 3.3V Clock-Recovery and Data-Retiming IC with Limiting Amplifier

## ABSOLUTE MAXIMUM RATINGS

Supply Voltage, $V_{CC}$ .....	-0.5V to +6.5V	CFILT.....	( $V_{CC} - 2.5V$ ) to ( $V_{CC} + 0.5V$ )
Input Voltage Levels, DDI+, DDI-, ADI+, ADI-.....	-0.5V to ( $V_{CC} + 0.5V$ )	INV.....	-0.5V to +2.0V
Input Differential Voltage (ADI+) - (ADI-).....	$\pm 3V$	Continuous Power Dissipation ( $T_A = +85^\circ C$ )	
PECL Output Currents, SDO+, SDO-, SCLKO+, SCLKO-.....	100mA	TQFP (derate 18.7mW/ $^\circ C$ above +85 $^\circ C$ ).....	1214.8mW
LOL, LOP, INSEL, PHADJ+, PHADJ-.....	-0.5V to ( $V_{CC} + 0.5V$ )	Operating Junction Temperature Range.....	-40 $^\circ C$ to +150 $^\circ C$
FIL-, OLC+, OLC-, RSSI, VTH.....	-0.5V to ( $V_{CC} + 0.5V$ )	Storage Temperature Range.....	-65 $^\circ C$ to +150 $^\circ C$
(OLC+) - (OLC-).....	$\pm 3V$	Processing Temperature (die).....	+400 $^\circ C$
FIL+.....	Internally connected to $V_{CC}$	Lead Temperature (soldering, 10sec).....	+300 $^\circ C$

Stresses beyond those listed under "Absolute Maximum Ratings" may cause permanent damage to the device. These are stress ratings only, and functional operation of the device at these or any other conditions beyond those indicated in the operational sections of the specifications is not implied. Exposure to absolute maximum rating conditions for extended periods may affect device reliability.

## DC ELECTRICAL CHARACTERISTICS

( $V_{CC} = +3.0V$  to +5.5V,  $T_A = -40^\circ C$  to +85 $^\circ C$ , unless otherwise noted. Typical values are at  $T_A = +25^\circ C$ .) (Note 1)

PARAMETER	SYMBOL	CONDITIONS	MIN	TYP	MAX	UNITS
Supply Current	$I_{CC}$	MAX3676EHJ, PECL outputs unterminated	INSEL = $V_{CC}$	72	111	mA
			INSEL = GND	51	81	
PECL Input-Voltage High	$V_{IH}$		$V_{CC} - 1.16$		$V_{CC} - 0.88$	V
PECL Input-Voltage Low	$V_{IL}$		$V_{CC} - 1.81$		$V_{CC} - 1.48$	V
PECL Input-Current High	$I_{IH}$		-10		10	$\mu A$
PECL Input-Current Low	$I_{IL}$		-10		10	$\mu A$
PECL Output-Voltage High	$V_{OH}$	$T_A = 0^\circ C$ to +85 $^\circ C$	$V_{CC} - 1.025$		$V_{CC} - 0.88$	V
		$T_A = -40^\circ C$	$V_{CC} - 1.085$		$V_{CC} - 0.88$	
PECL Output-Voltage Low	$V_{OL}$	$T_A = 0^\circ C$ to +85 $^\circ C$	$V_{CC} - 1.81$		$V_{CC} - 1.620$	V
		$T_A = -40^\circ C$	$V_{CC} - 1.83$		$V_{CC} - 1.555$	
LOP, LOL Voltage High	$V_{OH}$		2.4			V
LOP, LOL Voltage Low	$V_{OL}$				0.4	V
INV Input Bias Voltage		4k $\Omega$ between INV and VTH	1.10	1.23	1.30	V

**Note 1:** At  $T_A = -40^\circ C$ , DC characteristics are guaranteed by design and characterization.

# 622Mbps, 3.3V Clock-Recovery and Data-Retiming IC with Limiting Amplifier

MAX3676

## AC ELECTRICAL CHARACTERISTICS

( $V_{CC} = +3.0V$  to  $+5.5V$ ,  $T_A = -40^{\circ}C$  to  $+85^{\circ}C$ , unless otherwise noted. Typical values are at  $V_{CC} = +3.3V$  and  $T_A = +25^{\circ}C$ .) (Notes 2, 3)

PARAMETER	SYMBOL	CONDITIONS	MIN	TYP	MAX	UNITS
Differential Input Voltage Range	$V_{ID}$	BER < $10^{-10}$ , ADI inputs (Note 4)	0.003		1.2000	$V_{P-P}$
Input-Referred Noise	$V_N$	ADI inputs		80		$\mu V_{RMS}$
Power-Detect Hysteresis		(Notes 5, 6)	3		6	dB
Limiting Amplifier Small-Signal Bandwidth	BW	(Note 7)		650		MHz
RSSI Output Voltage		(ADI+) - (ADI-) = $2mV_{P-P}$		1.40		V
		(ADI+) - (ADI-) = $20mV_{P-P}$		1.93		
Threshold Voltage	$V_{TH}$	(Note 6)		1.41		V
LOP Threshold Accuracy		(Note 6)	-2		+2	dB
RSSI Linearity		(ADI+) - (ADI-) = $2mV_{P-P}$ to $50mV_{P-P}$		$\pm 0.7$		%
RSSI Slope		(ADI+) - (ADI-) = $2mV_{P-P}$ to $50mV_{P-P}$ (Note 8)		26		mV/dB
Loop Bandwidth		$C_F = 2.2\mu F$		250	500	kHz
Jitter Generation (Note 9)		$C_F = 2.2\mu F$		2.0	2.6	mUI
Jitter-Transfer Peaking		$C_F = 2.2\mu F$		0.03	0.08	dB
Jitter Tolerance (Note 10)		$C_F = 2.2\mu F$	f = 10kHz		8.9	UI
			f = 25kHz	(Note 11)	3.64	
			f = 250kHz	0.55	0.77	
			f = 1MHz	0.45	0.69	
Maximum Consecutive Input Run Length (1 or 0)				1200		Bits
Clock Transition Time	$t_r, t_f$	20% to 80%		205	245	ps
Data Transition Time	$t_r, t_f$	20% to 80%		180	230	ps
Serial Clock-to-Q Delay	$t_{CLK-Q}$		140	275	400	ps
Serial Clock Frequency	$f_{SCLK}$			622.08		MHz

**Note 2:** AC parameters are guaranteed by design and characterization.

**Note 3:** The MAX3676 is characterized with a PRBS of  $2^{23} - 1$  maintaining a BER of  $\leq 10^{-10}$  having a confidence level of 99.9%.

**Note 4:** A lower minimum input voltage of  $2mV_{P-P}$  is achievable; however, the LOP hysteresis is not guaranteed below  $3.6mV_{P-P}$ .

**Note 5:** Hysteresis =  $20\log(V_{RELEASE}/V_{ASSERT})$ .

**Note 6:**  $R_1 = 20k\Omega$ ,  $R_2 = 3.0k\Omega$ , resulting in  $V_{RELEASE} \approx 3.6mV_{P-P}$ .

**Note 7:** Small-signal bandwidth cannot be measured directly.

**Note 8:** RSSI slope =  $[V_{RSSI2} - V_{RSSI1}] / [20\log(V_{ID2}/V_{ID1})]$ .

**Note 9:**  $1UI = 1$  unit interval =  $(622.08MHz)^{-1} = 1.608ns$ .

**Note 10:** At jitter frequencies <10kHz, the jitter tolerance characteristics exceed the ITU/Bellcore specifications. The low-frequency jitter tolerance outperforms the instrument's measurement capability.

**Note 11:** See *Typical Operating Characteristics* for worst-case distribution.

# 622Mbps, 3.3V Clock-Recovery and Data-Retiming IC with Limiting Amplifier

## Typical Operating Characteristics

( $V_{CC} = +3.3V$ ,  $T_A = +25^\circ C$ , unless otherwise noted.)

**RECOVERED DATA AND CLOCK (SINGLE-ENDED)**

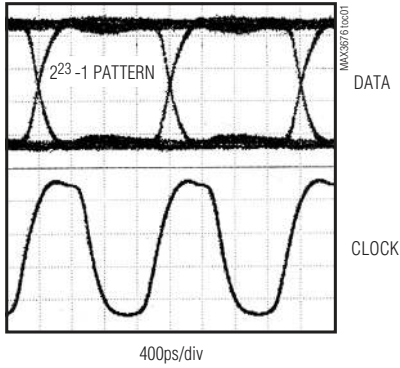

**RECOVERED CLOCK JITTER**

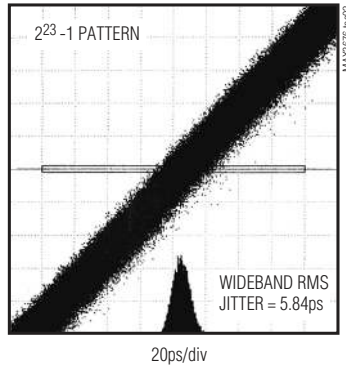

**BIT-ERROR RATE vs. ADI INPUT VOLTAGE**

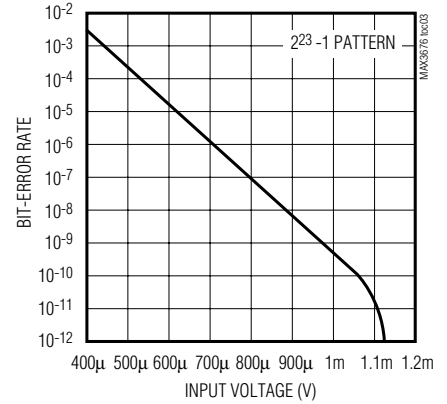

**JITTER TOLERANCE**

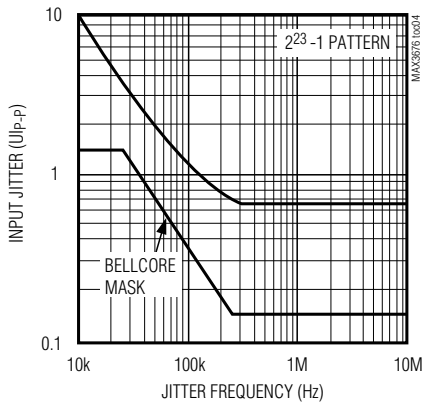

**JITTER TRANSFER**

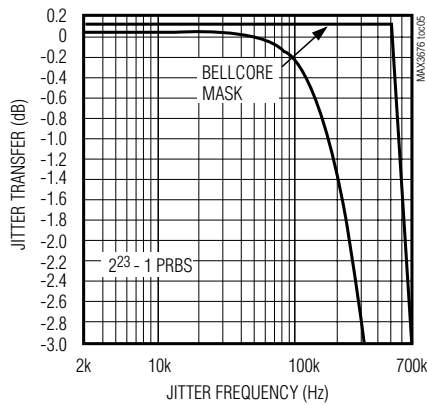

**DISTRIBUTION OF JITTER TOLERANCE (WORST-CASE CONDITIONS)**

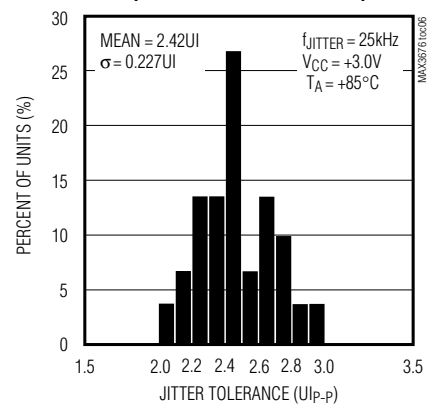

# 622Mbps, 3.3V Clock-Recovery and Data-Retiming IC with Limiting Amplifier

MAX3676

## Typical Operating Characteristics (continued)

( $V_{CC} = +3.3V$ ,  $T_A = +25^\circ C$ , unless otherwise noted.)

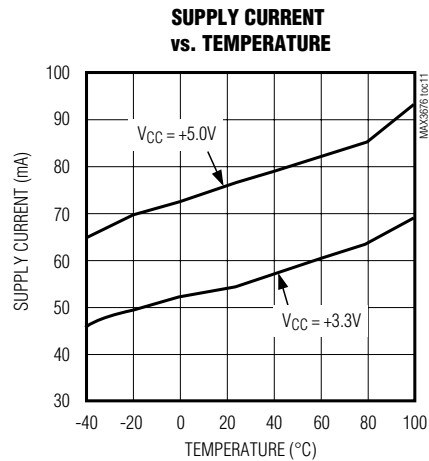
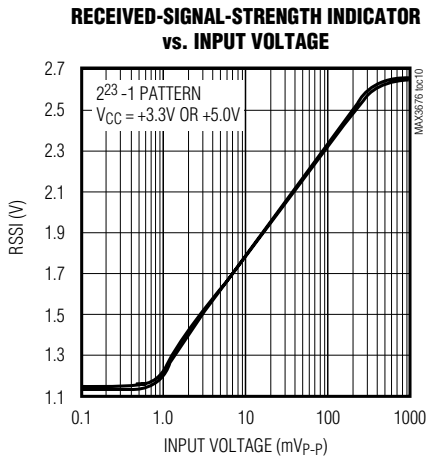
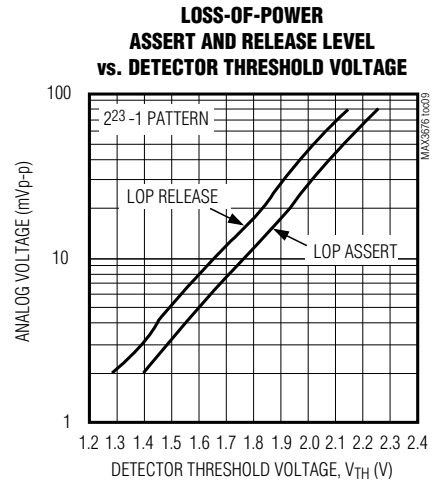
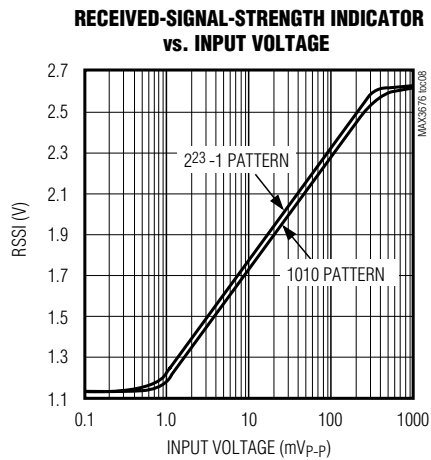
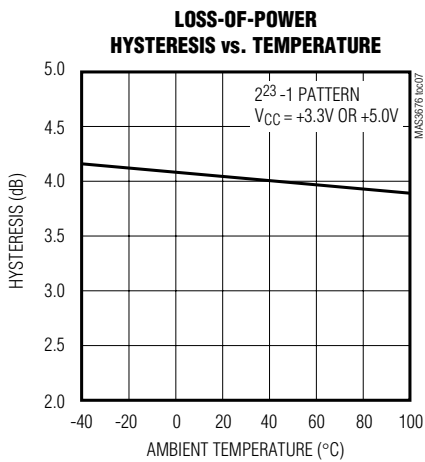

# 622Mbps, 3.3V Clock-Recovery and Data-Retiming IC with Limiting Amplifier

## Pin Description

PIN	NAME	FUNCTION
1	OLC+	Positive Offset-Correction Loop Capacitor Input
2	OLC-	Negative Offset-Correction Loop Capacitor Input
3	RSSI	Received-Signal-Strength Indicator Output
4, 8, 16, 24, 25	GND	Supply Ground
5	INV	Op Amp Inverting Input. Attach to ground if op amp is not used.
6	VTH	Voltage Threshold Input. Threshold voltage for loss-of-power monitor. Attach to V <sub>CC</sub> if LOP function is not used.
7	LOP	Loss-of-Power Output, TTL. Limiting amplifier loss-of-power monitor. Asserts high when input signal is below threshold set by VTH.
9, 12, 15, 18, 21, 31	V <sub>CC</sub>	Positive Supply Voltage
10	SCLKO-	Negative Serial-Clock Output, PECL, 622.08MHz. SDO- is clocked out on the falling edge of SCLKO-.
11	SCLKO+	Positive Serial-Clock Output, PECL, 622.08MHz. SDO+ is clocked out on the rising edge of SCLKO+.
13	SDO-	Negative Serial-Data Output, PECL, 622.08Mbps
14	SDO+	Positive Serial-Data Output, PECL, 622.08Mbps
17	$\overline{\text{LOL}}$	Loss-of-Lock Output, TTL. PLL loss-of-lock monitor, active low (see the <i>Design Procedure</i> section).
19	PHADJ-	Negative Phase-Adjust Input. Used to optimally align internal PLL phase. Attach to V <sub>CC</sub> if not used.
20	PHADJ+	Positive Phase-Adjust Input. Used to optimally align internal PLL phase. Attach to V <sub>CC</sub> if not used.
22	FIL-	Negative Filter Input. PLL loop filter connection. Connect a 2.2 $\mu$ F capacitor between FIL- and FIL+.
23	FIL+	Positive Filter Input. PLL loop filter connection. Internally connected to V <sub>CC</sub> .
26	DDI+	Positive Digital Data Input, PECL, 622.08Mbps serial-data stream
27	DDI-	Negative Digital Data Input, PECL, 622.08Mbps serial-data stream
28	INSEL	Input Select. Connect to GND to select digital data inputs or V <sub>CC</sub> for analog data inputs.
29	ADI-	Negative Analog Data Input, 622.08Mbps serial-data stream
30	ADI+	Positive Analog Data Input, 622.08Mbps serial-data stream
32	CFILT	RSSI Filter Capacitor Input. Connect a 47nF capacitor between CFILT and V <sub>CC</sub> .

# 622Mbps, 3.3V Clock-Recovery and Data-Retiming IC with Limiting Amplifier

MAX3676

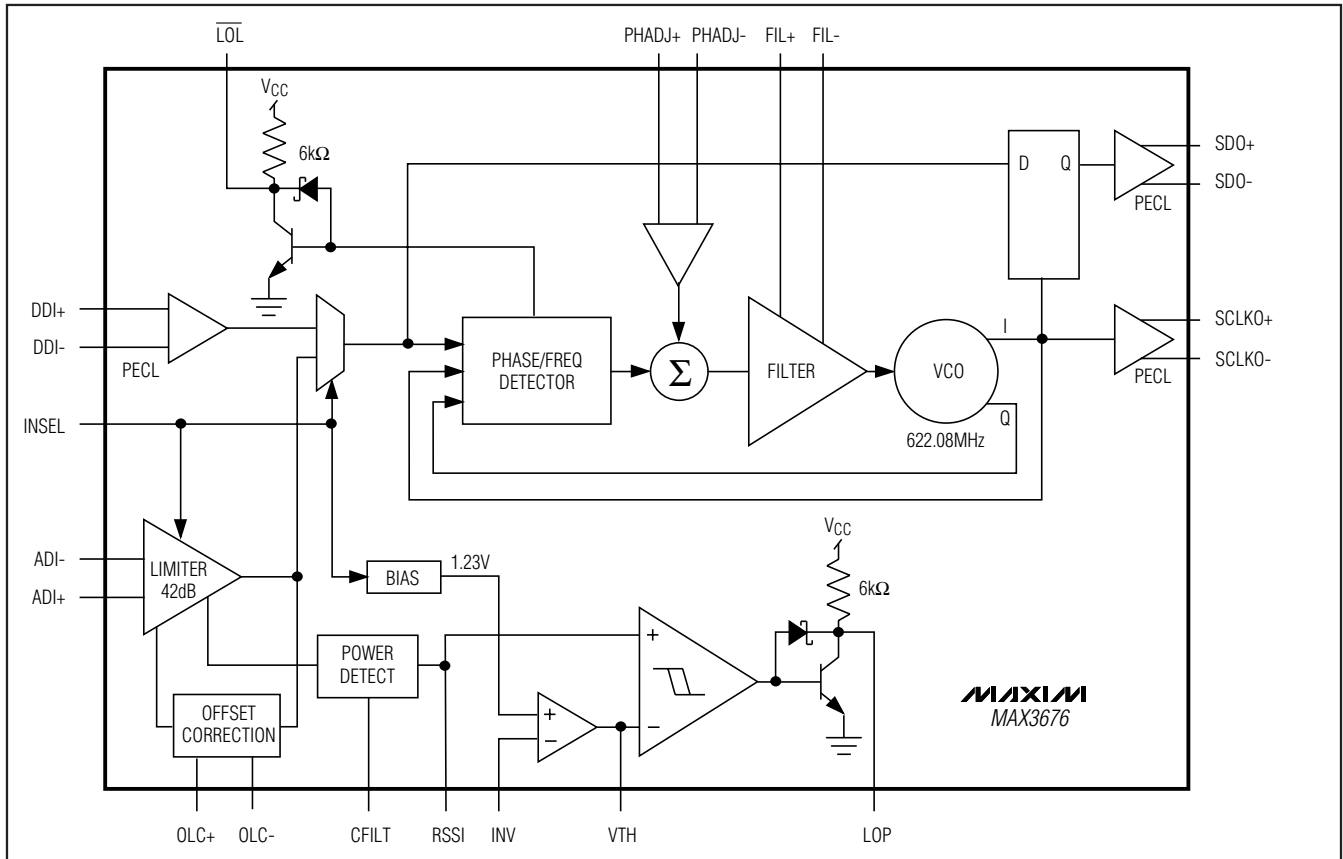

Figure 1. Functional Diagram

## Detailed Description

The block diagram in Figure 1 shows the MAX3676's architecture. It consists of a limiting-amplifier input stage followed by a fully integrated clock/data-recovery (CDR) block implemented with a PLL. The input stage is selectable between a limiting amplifier or a simple PECL input buffer. The limiting amplifier provides an LOP monitor and an RSSI output. The PLL consists of a phase/frequency detector (PFD), a loop filter amplifier, and a voltage-controlled oscillator (VCO).

### Limiting Amplifier

The MAX3676's on-chip limiting amplifier accepts an input signal level from 3.0mV<sub>P-P</sub> to 1.2V<sub>P-P</sub>. The amplifier consists of a cascade of gain stages that include full-wave logarithmic detectors. The combined small-signal gain is approximately 42dB, and the -3dB bandwidth is 650MHz. Input-referred noise is typically 80μV<sub>RMS</sub>, pro-

viding excellent sensitivity for small-amplitude data streams.

In addition to driving the CDR, the limiting amplifier provides both an RSSI output and an LOP monitor that allow the user to program the threshold voltage. The RSSI circuitry provides an output voltage that is linearly proportional to the input power (in decibels) detected between the ADI+ and ADI- input pins and is sensitive enough to reliably detect signals as small as 2mV<sub>P-P</sub> (see the *Typical Operating Characteristics*).

Input DC offset reduces the accuracy of the power detector; therefore, an integrated feedback loop is included that automatically nulls the input offset of the gain stage. The addition of this offset-correction loop requires that the input signal be AC-coupled when using the ADI+ and ADI- inputs.

Finally, for applications that do not require the limiting amplifier, selecting the digital inputs conserves power by turning off the postamplifier block.

# 622Mbps, 3.3V Clock-Recovery and Data-Retiming IC with Limiting Amplifier

## Phase Detector

The phase detector produces a voltage proportional to the phase difference between the incoming data and the internal clock. Because of its feedback nature, the PLL drives the error voltage to zero, aligning the recovered clock to the incoming data. The external phase adjustment pins (PHADJ+, PHADJ-) allow the user to vary the internal phase alignment.

## Frequency Detector

The frequency detector incorporated into the PLL uses the input data stream edges to sample the quadrature components of the VCO clock. This generates a difference frequency that aids acquisition during startup. Depending on the polarity of the difference frequency, the PFD drives the VCO so that the difference frequency is reduced to zero. Once frequency acquisition is obtained, the frequency detector returns to a neutral state.

## Loop Filter and VCO

The VCO is fully integrated, while the loop filter requires an external capacitor ( $C_F$ ). This filter network determines the bandwidth and peaking of the second-order PLL.

## Design Procedure

### Received-Signal-Strength Indicator

The RSSI output voltage is insensitive to temperature and supply fluctuations. The power detector functions as a broadband power meter that detects the total RMS power of all signals within the detector bandwidth (including input signal noise). The RSSI voltage varies linearly (in decibels) for inputs of 2mV<sub>P-P</sub> to 50mV<sub>P-P</sub>. The slope over this input range is approximately 26mV/dB.

The high-speed RSSI signal is filtered to an RMS level with one external capacitor tied from CFILT to VCC. The impedance looking into CFILT is about 500Ω to VCC. As a result, the lower -3dB cutoff frequency is set by the following simple relationship:

$$f_{\text{FILT}} = 1/[2\pi(500)C_{\text{FILT}}]$$

For 622Mbps applications, Maxim recommends a cut-off frequency of 6.8kHz, which requires  $C_{\text{FILT}} = 47\text{nF}$ . The RSSI output is designed to drive a minimum load resistance of 100kΩ to ground and a maximum of 20pF. Loads greater than 20pF must be buffered by a series resistance of 100kΩ (i.e., voltmeter).

### Input Offset Correction

The on-chip limiting amplifier provides more than 42dB of gain. A low-frequency feedback loop is integrated

into the MAX3676 to remove the input offset. DC-coupling to the ADI+ and ADI- inputs is not allowed, as this would prevent the proper functioning of the DC offset-correction circuitry.

The differential input impedance ( $Z_{\text{IN}}$ ) is approximately 2.5kΩ. The impedance between OLC+ and OLC- ( $Z_{\text{OLC}}$ ) is approximately 120kΩ. Take care when setting the combined low-frequency cutoff ( $f_{\text{CUTOFF}}$ ), due to the input DC-blocking capacitor ( $C_{\text{IN}}$ ) and the offset correction loop capacitor ( $C_{\text{OLC}}$ ). See Table 1 for selecting the values of  $C_{\text{IN}}$  and  $C_{\text{OLC}}$ .

These values ensure that the poles associated with  $C_{\text{IN}}$  and  $C_{\text{OLC}}$  work together to provide a flat response at the lower -3dB corner frequency (no gain peaking).

$C_{\text{IN}}$  must be a low-TC, high-quality capacitor of type X7R or better in order to minimize  $f_{\text{CUTOFF}}$  deviations.  $C_{\text{OLC}}$  must be a capacitor of type Z5U or better.

### Loss-of-Power Monitor

An LOP monitor with a user-programmable threshold and a hysteresis comparator is also included with the limiting amplifier circuitry. Internally, one comparator input is tied to the RSSI output signal, and the other is tied to the threshold voltage ( $V_{\text{TH}}$ ), which is set externally and provides a trip point for the LOP indication. A low-voltage, low-drift op amp, referenced to an internal bandgap voltage (1.23V), is supplied for programming a supply independent threshold voltage. This op amp requires two external resistors to program the LOP trip point.  $V_{\text{TH}}$  is programmable from 1.23V to 2.6V using the equation:

$$V_{\text{TH}} = 1.23(1 + R_2/R_1)$$

The op amp can source only 100μA of current. Therefore, an  $R_1$  value of 20kΩ is recommended for proper operation. The input bias current of the op amp at the INV pin is less than ±100nA.

**Table 1. Setting the Low-Frequency Cutoff**

$C_{\text{IN}}$	$C_{\text{OLC}}$	COMBINED LOW $f_{\text{CUTOFF}}$ (kHz)
0.022μF	0.15μF	3.0
0.010μF	0.1μF	6.8
6800pF	0.082μF	10
4700pF	0.033μF	13.5
2200pF	0.015μF	29
1000pF	0.01μF	68
470pF	3300pF	135
330pF	2200pF	190
220pF	1500pF	290



# 622Mbps, 3.3V Clock-Recovery and Data-Retiming IC with Limiting Amplifier

The comparator is configured with an active-high LOP output. An on-chip, 6kΩ pull-up resistor is provided to reduce the external part count.

## Setting the Loop Filter

The MAX3676 is designed for both regenerator and receiver applications. Its fully integrated PLL is a classic second-order feedback system, with a loop bandwidth ( $f_L$ ) fixed at 250kHz. The external capacitor,  $C_F$ , can be adjusted to set the loop damping. Figures 2 and 3 show the open-loop and closed-loop transfer functions. The PLL zero frequency,  $f_Z$ , is a function of external capacitor  $C_F$ , and can be approximated according to:

$$f_Z = \frac{1}{2\pi(90) C_F}$$

For an overdamped system ( $f_Z/f_L$ ) < 0.25, the jitter peaking ( $M_P$ ) of a second-order system can be approximated by:

$$M_P = 20\log\left(1 + \frac{f_Z}{f_L}\right)$$

For example, using  $C_F = 0.22\mu\text{F}$  results in a jitter peaking of 0.27dB. Reducing  $C_F$  below 0.22μF may result in PLL instability. The recommended value for  $C_F$  is 2.2μF to guarantee a maximum jitter peaking of less than 0.1dB.

The MAX3676 is optimally designed to acquire lock and to provide a bit-error rate (BER) of less than  $10^{-10}$  for long strings of consecutive zeros and ones. Measured results show that the MAX3676 can tolerate 1200 consecutive ones or zeros. Decreasing  $C_F$  reduces the number of tolerated consecutive identical zeros and ones.  $C_F$  must be a low-TC, high-quality capacitor of type X7R or better.

## Lock Detect

The MAX3676's LOL monitor indicates when the PLL is locked. Under normal operation, the loop is locked and the  $\overline{\text{LOL}}$  output signal is high. When the MAX3676 loses lock, a fast negative-edge transition occurs on  $\overline{\text{LOL}}$ . The output level remains at a low level (held by  $C_{\text{LOL}}$ ) until the loop reacquires lock (Figure 4).

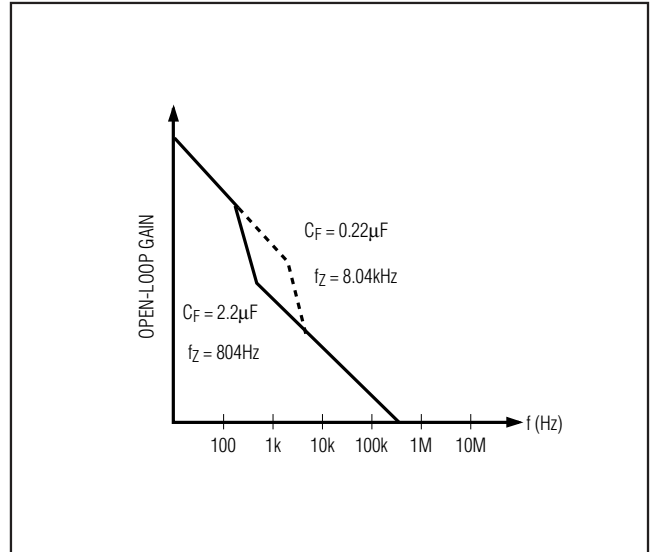

Figure 2. Open-Loop Transfer Function

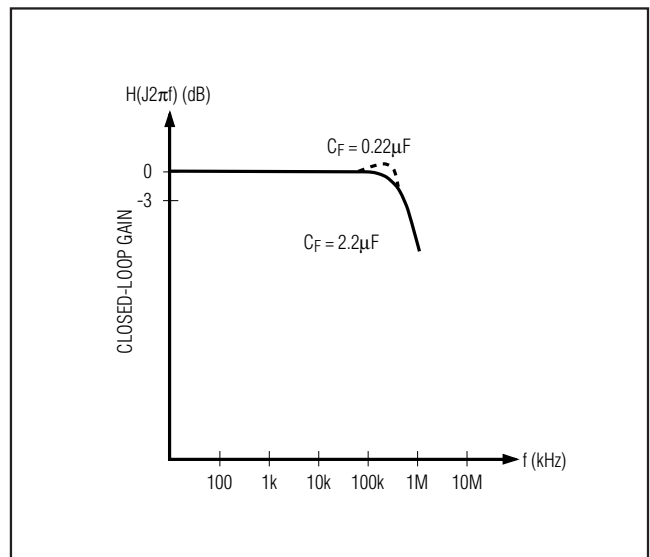

Figure 3. Closed-Loop Transfer Function

# 622Mbps, 3.3V Clock-Recovery and Data-Retiming IC with Limiting Amplifier

Note that the LOL monitor is only valid when a data stream is present on the inputs to the MAX3676. As a result, LOL does not detect a loss-of-power condition resulting from a loss of the incoming signal. See the *Loss-of-Power Monitor* section for this type of indicator.

## Input and Output Terminations

The MAX3676 digital data and clock I/Os (DDI+, DDI-, SDO+, SDO-, SCLK+, and SCLK-) are designed to interface with PECL signal levels. It is important to bias these ports appropriately. A circuit that provides a Thevenin equivalent of  $50\Omega$  to  $V_{CC} - 2V$  should be used with fixed-impedance transmission lines for proper termination. Make sure that the differential outputs have balanced loads.

The digital data input signals (DDI+ and DDI-) are differential inputs to an emitter-coupled pair. As a result, the MAX3676 can accept differential input signals as low as 250mV. These inputs can also be driven single-ended by externally biasing DDI- to the center of the voltage swing.

The MAX3676's performance can be greatly affected by circuit board layout and design. Use good high-fre-

quency design techniques, including minimizing ground inductance and using fixed-impedance transmission lines on the data and clock signals. Power-supply decoupling should be placed as close to  $V_{CC}$  as possible. Take care to isolate the input from the output signals to reduce feedthrough.

## Applications Information

### Driving the Limiting Amplifier Single-Ended

There are three important requirements for driving the limiting amplifier from a single-ended source (Figure 5):

- 1) There must be no DC-coupling to the ADI+ and ADI- inputs. DC levels at these inputs disrupt the offset-correction loop.
- 2) The terminating resistor  $R_T$  ( $50\Omega$ ) must be referenced to the ADI- input to minimize common-mode coupling problems.
- 3) The low-frequency cutoff for the limiting amplifier is determined by either  $C_{IN}$  and the  $2.5k\Omega$  input impedance or  $C_b/2$  together with  $R_T$ . With  $C_b = 0.22\mu F$  and  $R_T = 50\Omega$ , the low-frequency cutoff is 29kHz.

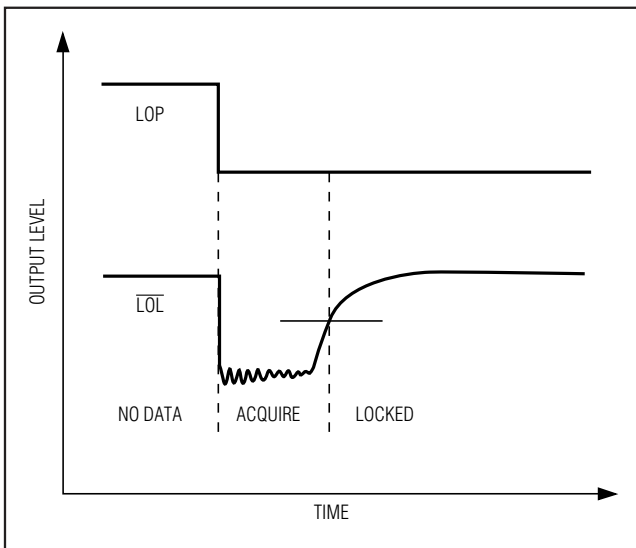

Figure 4. Loss-of-Lock Output

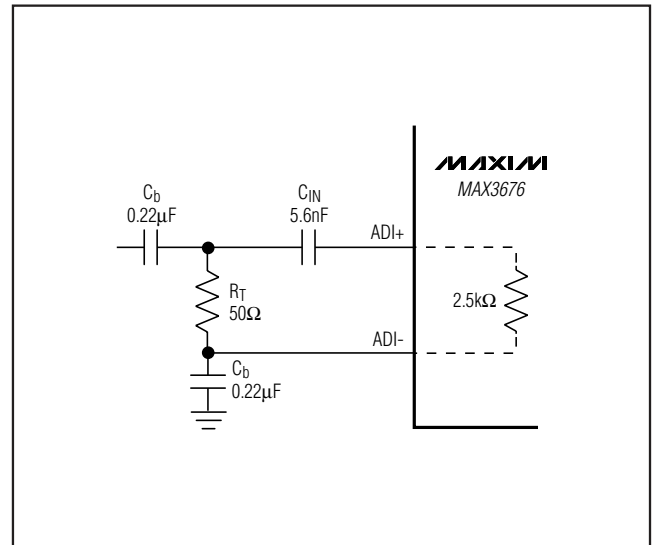

Figure 5. Single-Ended Input Termination

# 622Mbps, 3.3V Clock-Recovery and Data-Retiming IC with Limiting Amplifier

## Reduced Power Consumption Without the Limiting Amplifier

The limiting amplifier is biased independently from the clock recovery circuitry. Grounding INSEL turns off the limiting amplifier and selects the PECL DDI inputs.

## Converting Average Optical Power to Signal Amplitude

Many of the MAX3676's specifications relate to input-signal amplitude. When working with fiber optic receivers, the input is usually expressed in terms of average optical power and extinction ratio. The relations given in Table 2 and Figure 6 are helpful for converting optical power to input signal when designing with the MAX3676.

In an optical receiver, the input voltage to the limiting amplifier can be found by multiplying the relationship in Table 2 by the photodiode responsivity and transimpedance amplifier gain.

## Optical Hysteresis

Power and hysteresis are often expressed in decibels. By definition, decibels are always  $10\log(\text{power})$ . At the inputs to the MAX3676 limiting amplifier, the power is  $V_{IN}^2/R$ . If a receiver's optical input power (x) increases by a factor of two, and the preamplifier is linear, then the voltage at the input to the MAX3676 also increases by a factor of two.

The optical power increase is:

$$10\log(2x/x) = 10\log(2) = +3\text{dB}$$

At the MAX3676, the voltage increase is:

$$10\log \frac{(2V_{IN})^2/R}{V_{IN}^2/R} = 10\log(2^2) = 20\log(2) = +6\text{dB}$$

**Table 2. Optical-Power Relations\***

PARAMETER	SYMBOL	RELATION
Average Power	$P_{AVG}$	$P_{AVG} = (P_0 + P_1) / 2$
Extinction Ratio	$r_e$	$r_e = P_1 / P_0$
Optical Power of a "1"	$P_1$	$P_1 = 2P_{AVG} \frac{r_e}{r_e + 1}$
Optical Power of a "0"	$P_0$	$P_0 = 2P_{AVG} / (r_e + 1)$
Signal Amplitude	$P_{IN}$	$P_{IN} = P_1 - P_0 = 2P_{AVG} \frac{(r_e - 1)}{r_e + 1}$

\*Assuming a 50% average input-data duty cycle.

In an optical receiver, the decibel change at the MAX3676 always equals 2x the optical decibel change.

The MAX3676's typical voltage hysteresis is 3.0dB. This provides an optical hysteresis of 1.5dB.

## Jitter in Optical Receivers

Timing jitter, edge speeds, aberrations, optical dispersion, and attenuation all impact the performance of high-speed clock recovery for SDH/SONET receivers (Figure 7). These effects decrease the time available for error-free data recovery by reducing the received "eye opening" of nonreturn-to-zero (NRZ) transmitted signals.

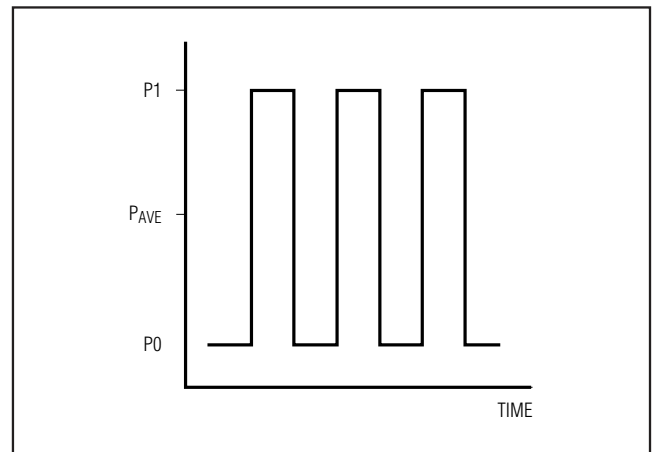

Figure 6. Optical Power Relations

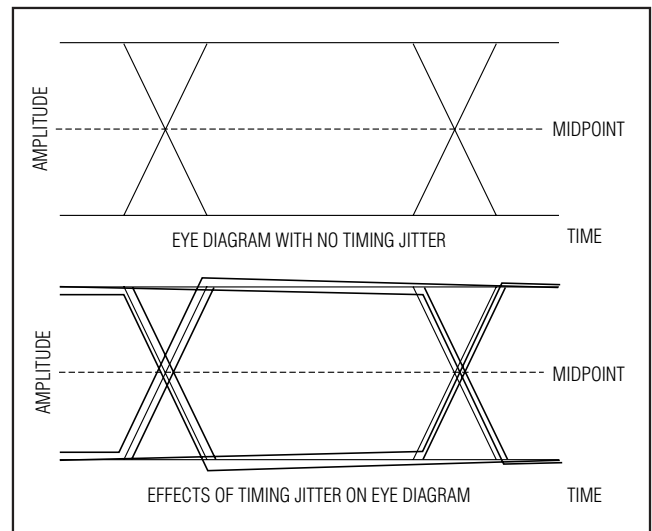

Figure 7. Eye Diagram With and Without Timing Jitter

# 622Mbps, 3.3V Clock-Recovery and Data-Retiming IC with Limiting Amplifier

Optical receivers, incorporating transimpedance preamplifiers and limiting postamplifiers, can significantly clean up the effects of dispersion and attenuation. In addition, these amplifiers can provide fast transitions with minimal aberrations to the subsequent CDR blocks. However, these stages also add distortions to the midpoint crossing, contributing to timing jitter. Timing jitter is one of the most critical technical issues to consider when developing optical receivers and CDR circuits.

A better understanding of the different sources of jitter helps in the design and application of optical receiver modules and integrated CDR solutions. SDH/SONET specifications are well defined regarding the amount of jitter tolerance allowed at the inputs of optical receivers, as well as jitter peaking requirements, but they do little to define the different sources of jitter. The jitter that must be tolerated at an optical receiver input involves three significant sources, all of which are present in varying degrees in typical receiver systems:

- 1) Random jitter (RJ)
- 2) Pattern-dependent jitter (PDJ)
- 3) Pulse-width distortion (PWD)

### Random Jitter

RJ is caused by random noise present during edge transitions (Figure 8). This random noise results in random midpoint crossings. All electrical systems generate some random noise; however, the faster the speed

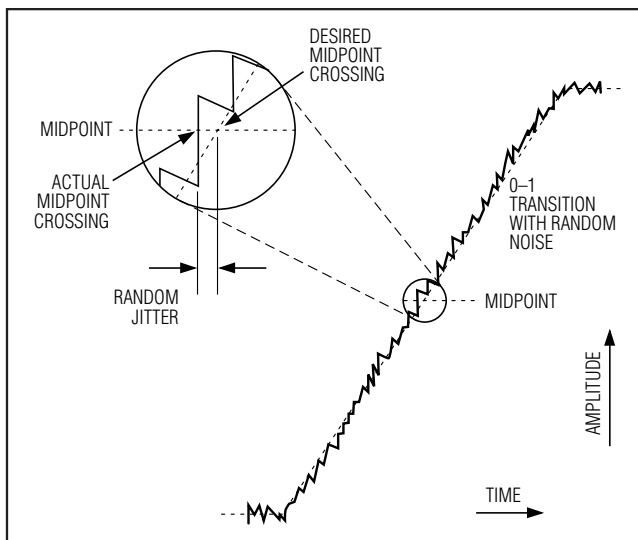

Figure 8. Random Jitter on Edge Transition

of the transitions, the lower the effect of noise on random jitter. The following equation is a simple worst-case estimation of random jitter:

$$RJ \text{ (rms)} = (\text{rms noise})/(\text{slew rate})$$

### Pattern-Dependent Jitter

PDJ results from wide variations in the number of consecutive bits contained in NRZ data streams working against the bandwidth requirements of the receiver (Figure 9). The location of the lower -3dB cutoff frequency is important, and must be set to pass the low frequencies associated with long consecutive bit streams. AC-coupling is common in optical receiver design.

When using a preamplifier with a highpass frequency response, select the input AC-coupling capacitor,  $C_{IN}$ , to provide a low-frequency cutoff ( $f_C$ ) one decade lower than the preamplifier low-frequency cutoff. As a result, the PDJ is dominated by the low-frequency cutoff of the preamplifier.

When using a preamplifier without a highpass response with the MAX3676, the following equation provides a good starting point for choosing  $C_{IN}$ :

$$C_{IN} \geq \frac{-t_L}{(1.25k\Omega) \ln \left[ 1 - \frac{(PDJ)(BW)}{0.5} \right]}$$

where  $t_L$  = duration of the longest run of consecutive bits of the same value (seconds); PDJ = maximum

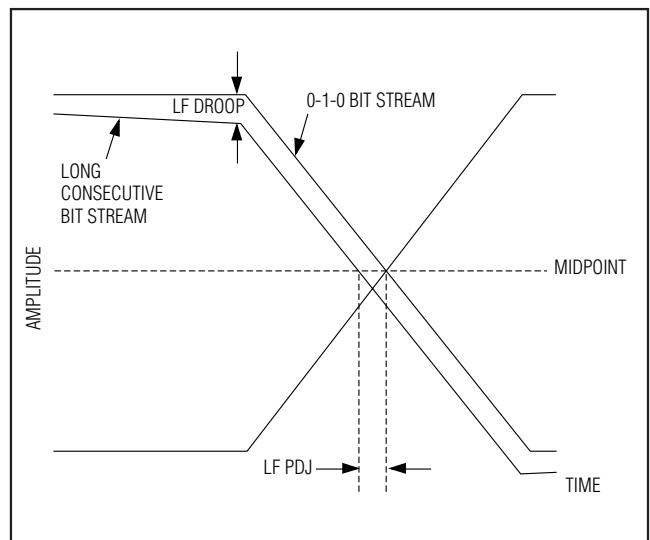

Figure 9. Pattern-Dependent Jitter Due to Low-Frequency Cutoff

# 622Mbps, 3.3V Clock-Recovery and Data-Retiming IC with Limiting Amplifier

allowable pattern-dependent jitter, peak-to-peak (seconds); and BW = typical system bandwidth, normally 0.6 to 1.0 times the data rate (Hertz). If the PDJ is still larger than desired, continue increasing the value of C<sub>IN</sub>. Note that to maintain stability when using the MAX3676 analog inputs (ADI+, ADI-), it is important to keep the low-frequency cutoff associated with C<sub>OLC</sub> below the corner frequency associated with C<sub>IN</sub> (f<sub>c</sub>) (Table 1).

PDJ can also be present due to insufficient high-frequency bandwidth (Figure 10). If the amplifiers are not fast enough to allow for complete transitions during single-bit patterns, or if the amplifier does not allow adequate settling time, high-frequency PDJ can result.

### Pulse-Width Distortion

Finally, PWD occurs when the midpoint crossing of a 0–1 transition and a 1–0 transition does not occur at the

same level (Figure 11). DC offsets and nonsymmetrical rising and falling edge speeds both contribute to PWD. For a 1–0 bit stream, calculate PWD as follows:

$$PWD = \frac{[(\text{width of wider pulse}) - (\text{width of narrower pulse})]}{2}$$

### Phase Adjust

The internal clock and data alignment in the MAX3676 is well maintained close to the center of the data eye. Although not required, this sampling point can be shifted using the PHADJ inputs to optimize BER performance. The PHADJ inputs operate with differential input signals to approximately ±1V. A simple resistor divider with a bypass capacitor is sufficient to set up these levels. When the PHADJ inputs are not used, they should be tied directly to V<sub>CC</sub>.

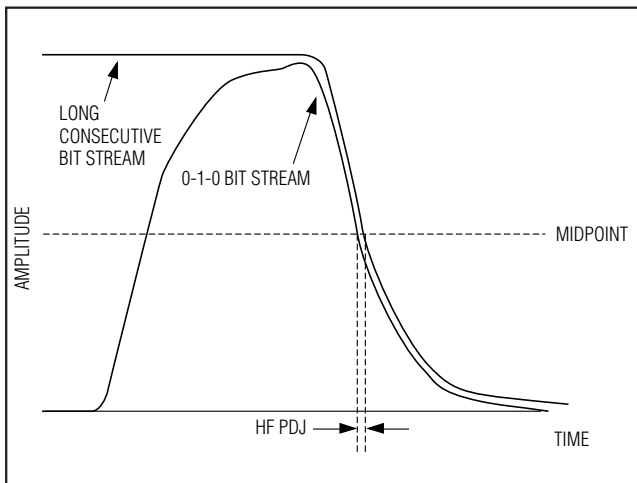

Figure 10. Pattern-Dependent Jitter Due to High-Frequency Roll-off

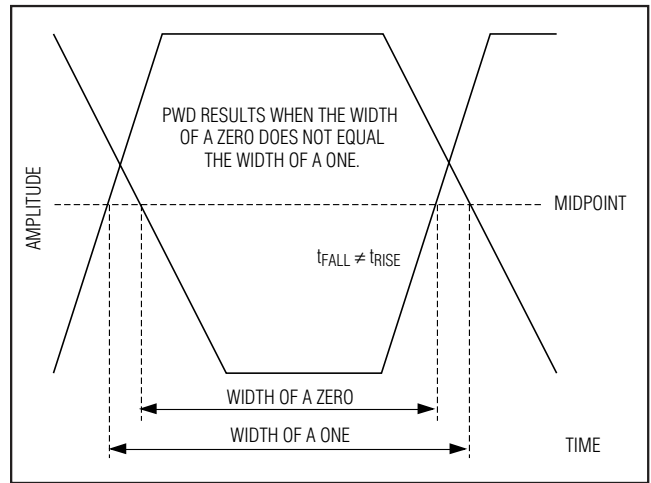
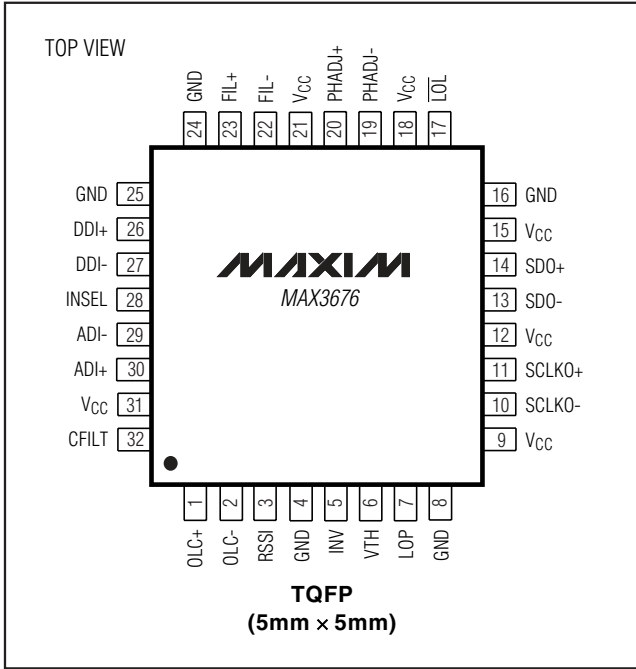

Figure 11. Pulse-Width Distortion

# 622Mbps, 3.3V Clock-Recovery and Data-Retiming IC with Limiting Amplifier

## Pin Configuration



## Chip Information

TRANSISTOR COUNT: 2528

## Package Information

For the latest package outline information and land patterns, go to [www.maxim-ic.com/packages](http://www.maxim-ic.com/packages).

PACKAGE TYPE	PACKAGE CODE	DOCUMENT NO.
32 TQFP	H32-4F	<a href="#">21-0110</a>

# 622Mbps, 3.3V Clock-Recovery and Data-Retiming IC with Limiting Amplifier

## Revision History

**MAX3676**

REVISION NUMBER	REVISION DATE	DESCRIPTION	PAGES CHANGED
0	2/00	Initial release.	—
1	4/00	Corrected the <i>Package Information</i> section.	15
2	12/01	Corrected the <i>Chip Topography</i> .	14
3	4/05	Added lead-free package to the <i>Ordering Information</i> table.	1
		Changed the <i>Absolute Maximum Ratings</i> specification for Continuous Power Dissipation.	2
4	3/09	Removed the dice package information from the <i>Ordering Information</i> and <i>DC Electrical Characteristics</i> tables.	1, 2, 3
		Added C <sub>F</sub> to the 22μF capacitor and changed C <sub>F</sub> to C <sub>FILT</sub> for the 47nF capacitor in the <i>Typical Operating Circuit</i> and corrected the capacitor references in the <i>Loop Filter and VCO</i> and <i>Received-Signal-Strength Indicator</i> sections.	1, 8
		Updated the <i>Absolute Maximum Ratings</i> for the FIL+ pin; removed Note 1 and renumbered notes in the <i>DC Electrical Characteristics</i> table and removed the LOP, LOL Voltage Low min specification.	2, 3
		Removed the <i>Chip Topography</i> section.	14

Maxim cannot assume responsibility for use of any circuitry other than circuitry entirely embodied in a Maxim product. No circuit patent licenses are implied. Maxim reserves the right to change the circuitry and specifications without notice at any time.

**Maxim Integrated Products, 120 San Gabriel Drive, Sunnyvale, CA 94086 408-737-7600** \_\_\_\_\_ 15