

## 6A Austin MicroLynx II™: SMT Non-Isolated DC-DC Power Module

2.4Vdc –5.5Vdc input; 0.75Vdc to 3.63Vdc output; 6A Output Current



RoHS Compliant



**EZ-SEQUENCE™**

### Features

- Compliant to RoHS Directive 2011/65/EU and amended Directive (EU) 2015/863
- Compliant to REACH Directive (EC) No 1907/2006
- Flexible output voltage sequencing EZ-SEQUENCE™
- Delivers up to 6A output current
- High efficiency – 96% at 3.3V full load ( $V_{IN} = 5.0V$ )
- Small size and low profile:  
27.9 mm x 11.4 mm x 7.24 mm  
(1.10 in x 0.45 in x 0.285 in)
- Low output ripple and noise
- High Reliability:  
Calculated MTBF = 12.8M hours at 25°C Full-load
- Output voltage programmable from 0.75 Vdc to 3.63Vdc via external resistor
- Line Regulation: 0.3% (typical)
- Load Regulation: 0.4% (typical)
- Temperature Regulation: 0.4 % (typical)
- Remote On/Off
- Output overcurrent protection (non-latching)
- Wide operating temperature range (-40°C to 85°C)
- *ANSI/UL\* 62368-1 and CAN/CSA† C22.2 No. 62368-1 Recognized, DIN VDE‡ 0868-1/A11:2017 (EN62368-1:2014/A11:2017)*
- ISO\*\* 9001 and ISO 14001 certified manufacturing facilities

### Applications

- Distributed power architectures
- Intermediate bus voltage applications
- Telecommunications equipment
- Servers and storage applications
- Networking equipment
- Enterprise Networks
- Latest generation IC's (DSP, FPGA, ASIC) and Microprocessor powered applications

### Description

Austin MicroLynx™ II SMT (surface mount technology) power modules are non-isolated dc-dc converters that can deliver up to 6A of output current with full load efficiency of 96.0% at 3.3V output. These modules provide a precisely regulated output voltage programmable via an external resistor from 0.75Vdc to 3.63Vdc over a wide range of input voltage ( $V_{IN} = 2.4 - 5.5Vdc$ ). Austin MicroLynx™ II has a sequencing feature, EZ-SEQUENCE™ that enable designers to implement various types of output voltage sequencing when powering multiple modules on board.

\* UL is a registered trademark of Underwriters Laboratories, Inc.

† CSA is a registered trademark of Canadian Standards Association.

‡ VDE is a trademark of Verband Deutscher Elektrotechniker e.V.

\*\* ISO is a registered trademark of the International Organization of Standards

## 6A Austin MicroLynx™II: SMT Non-Isolated DC-DC Power Modules

2.4Vdc –5.5Vdc input; 0.75Vdc to 3.63Vdc output; 6A Output Current

### Absolute Maximum Ratings

Stresses in excess of the absolute maximum ratings can cause permanent damage to the device. These are absolute stress ratings only, functional operation of the device is not implied at these or any other conditions in excess of those given in the operations sections of the data sheet. Exposure to absolute maximum ratings for extended periods can adversely affect the device reliability.

| Parameter                                                             | Device | Symbol           | Min  | Max                 | Unit |
|-----------------------------------------------------------------------|--------|------------------|------|---------------------|------|
| Input Voltage<br>Continuous                                           | All    | V <sub>IN</sub>  | -0.3 | 5.8                 | Vdc  |
| Sequencing voltage                                                    | All    | V <sub>seq</sub> | -0.3 | V <sub>IN,max</sub> | Vdc  |
| Operating Ambient Temperature<br>(see Thermal Considerations section) | All    | T <sub>A</sub>   | -40  | 85                  | °C   |
| Storage Temperature                                                   | All    | T <sub>stg</sub> | -55  | 125                 | °C   |

### Electrical Specifications

Unless otherwise indicated, specifications apply over all operating input voltage, resistive load, and temperature conditions.

| Parameter                                                                                                                                                                                               | Device                                                       | Symbol                                             | Min | Typ      | Max  | Unit             |
|---------------------------------------------------------------------------------------------------------------------------------------------------------------------------------------------------------|--------------------------------------------------------------|----------------------------------------------------|-----|----------|------|------------------|
| Operating Input Voltage                                                                                                                                                                                 | V <sub>O,set</sub> ≤ 3.63                                    | V <sub>IN</sub>                                    | 2.4 | —        | 5.5  | Vdc              |
| Maximum Input Current<br>(V <sub>IN</sub> = V <sub>IN,min</sub> to V <sub>IN,max</sub> , I <sub>O</sub> = I <sub>O,max</sub> )                                                                          | All                                                          | I <sub>IN,max</sub>                                |     |          | 6.0  | Adc              |
| Input No Load Current<br>(V <sub>IN</sub> = V <sub>IN,nom</sub> , I <sub>O</sub> = 0, module enabled)                                                                                                   | V <sub>O,set</sub> = 0.75 Vdc<br>V <sub>O,set</sub> = 3.3Vdc | I <sub>IN,No load</sub><br>I <sub>IN,No load</sub> |     | 20<br>45 |      | mA<br>mA         |
| Input Stand-by Current<br>(V <sub>IN</sub> = V <sub>IN,nom</sub> , module disabled)                                                                                                                     | All                                                          | I <sub>IN,stand-by</sub>                           |     | 0.6      |      | mA               |
| Inrush Transient                                                                                                                                                                                        | All                                                          | I <sup>2</sup> t                                   |     |          | 0.04 | A <sup>2</sup> s |
| Input Reflected Ripple Current, peak-to-peak<br>(5Hz to 20MHz, 1μH source impedance; V <sub>IN,min</sub> to V <sub>IN,max</sub> , I <sub>O</sub> = I <sub>O,max</sub> ; See Test configuration section) | All                                                          |                                                    |     | 35       |      | mAp-p            |
| Input Ripple Rejection (120Hz)                                                                                                                                                                          | All                                                          |                                                    |     | 30       |      | dB               |

**CAUTION: This power module is not internally fused. An input line fuse must always be used.**

This power module can be used in a wide variety of applications, ranging from simple standalone operation to being part of a complex power architecture. To preserve maximum flexibility, internal fusing is not included, however, to achieve maximum safety and system protection, always use an input line fuse. The safety agencies require a fast-acting fuse with a maximum rating of 6 A (see Safety Considerations section). Based on the information provided in this data sheet on inrush energy and maximum dc input current, the same type of fuse with a lower rating can be used. Refer to the fuse manufacturer’s data sheet for further information.

## 6A Austin MicroLynx™II: SMT Non-Isolated DC-DC Power Modules

2.4Vdc –5.5Vdc input; 0.75Vdc to 3.63Vdc output; 6A Output Current

### Electrical Specifications (continued)

| Parameter                                                                                                                                                                                                                                                         | Device                                                                                                                                              | Symbol                                                   | Min         | Typ                                          | Max          | Unit                                               |
|-------------------------------------------------------------------------------------------------------------------------------------------------------------------------------------------------------------------------------------------------------------------|-----------------------------------------------------------------------------------------------------------------------------------------------------|----------------------------------------------------------|-------------|----------------------------------------------|--------------|----------------------------------------------------|
| Output Voltage Set-point<br>( $V_{IN}=V_{IN, min}$ , $I_o=I_{o, max}$ , $T_A=25^\circ C$ )                                                                                                                                                                        | All                                                                                                                                                 | $V_{o, set}$                                             | -2.0        | —                                            | +2.0         | % $V_{o, set}$                                     |
| Output Voltage<br>(Over all operating input voltage, resistive load, and temperature conditions until end of life)                                                                                                                                                | All                                                                                                                                                 | $V_{o, set}$                                             | -3.0        | —                                            | +3.0         | % $V_{o, set}$                                     |
| Adjustment Range<br>Selected by an external resistor                                                                                                                                                                                                              | All                                                                                                                                                 | $V_o$                                                    | 0.7525      |                                              | 3.63         | Vdc                                                |
| Output Regulation<br>Line ( $V_{IN}=V_{IN, min}$ to $V_{IN, max}$ )<br>Load ( $I_o=I_{o, min}$ to $I_{o, max}$ )<br>Temperature ( $T_{ref}=T_{A, min}$ to $T_{A, max}$ )                                                                                          | All<br>All<br>All                                                                                                                                   |                                                          | —<br>—<br>— | 0.3<br>0.4<br>0.4                            | —<br>—<br>—  | % $V_{o, set}$<br>% $V_{o, set}$<br>% $V_{o, set}$ |
| Output Ripple and Noise on nominal output<br>( $V_{IN}=V_{IN, nom}$ and $I_o=I_{o, min}$ to $I_{o, max}$<br>Cout = 1 $\mu$ F ceramic//10 $\mu$ F tantalum capacitors)                                                                                             |                                                                                                                                                     |                                                          |             |                                              |              |                                                    |
| RMS (5Hz to 20MHz bandwidth)                                                                                                                                                                                                                                      | All                                                                                                                                                 |                                                          | —           | 10                                           | 15           | mV <sub>rms</sub>                                  |
| Peak-to-Peak (5Hz to 20MHz bandwidth)                                                                                                                                                                                                                             | All                                                                                                                                                 |                                                          | —           | 40                                           | 50           | mV <sub>pk-pk</sub>                                |
| External Capacitance<br>ESR $\geq$ 1 m $\Omega$<br>ESR $\geq$ 10 m $\Omega$                                                                                                                                                                                       | All<br>All                                                                                                                                          | $C_{o, max}$<br>$C_{o, max}$                             | —<br>—      | —<br>—                                       | 1000<br>5000 | $\mu$ F<br>$\mu$ F                                 |
| Output Current                                                                                                                                                                                                                                                    | All                                                                                                                                                 | $I_o$                                                    | 0           |                                              | 6            | Adc                                                |
| Output Current Limit Inception (Hiccup Mode )<br>( $V_o=90\%$ of $V_{o, set}$ )                                                                                                                                                                                   | All                                                                                                                                                 | $I_{o, lim}$                                             | —           | 220                                          | —            | % $I_o$                                            |
| Output Short-Circuit Current<br>( $V_o \leq 250mV$ ) ( Hiccup Mode )                                                                                                                                                                                              | All                                                                                                                                                 | $I_{o, s/c}$                                             | —           | 2                                            | —            | Adc                                                |
| Efficiency<br>$V_{IN}=V_{IN, nom}$ , $T_A=25^\circ C$<br>$I_o=I_{o, max}$ , $V_o=V_{o, set}$                                                                                                                                                                      | $V_{o, set} = 0.75Vdc$<br>$V_{o, set} = 1.2Vdc$<br>$V_{o, set} = 1.5Vdc$<br>$V_{o, set} = 1.8Vdc$<br>$V_{o, set} = 2.5Vdc$<br>$V_{o, set} = 3.3Vdc$ | $\eta$<br>$\eta$<br>$\eta$<br>$\eta$<br>$\eta$<br>$\eta$ |             | 81.2<br>86.8<br>88.8<br>89.7<br>92.5<br>95.4 |              | %<br>%<br>%<br>%<br>%<br>%                         |
| Switching Frequency                                                                                                                                                                                                                                               | All                                                                                                                                                 | $f_{sw}$                                                 | —           | 300                                          | —            | kHz                                                |
| Dynamic Load Response<br>( $dI_o/dt=2.5A/\mu s$ ; $V_{IN}=V_{IN, nom}$ ; $T_A=25^\circ C$ )<br>Load Change from $I_o=50\%$ to $100\%$ of $I_{o, max}$ ; 1 $\mu$ F ceramic// 10 $\mu$ F tantalum<br>Peak Deviation<br>Settling Time ( $V_o < 10\%$ peak deviation) | All                                                                                                                                                 | $V_{pk}$                                                 | —           | 130                                          | —            | mV                                                 |
| ( $dI_o/dt=2.5A/\mu s$ ; $V_{IN}=V_{IN, nom}$ ; $T_A=25^\circ C$ )<br>Load Change from $I_o=100\%$ to $50\%$ of $I_{o, max}$ ; 1 $\mu$ F ceramic// 10 $\mu$ F tantalum<br>Peak Deviation<br>Settling Time ( $V_o < 10\%$ peak deviation)                          | All<br>All                                                                                                                                          | $t_s$<br>$V_{pk}$                                        | —<br>—      | 25<br>130                                    | —<br>—       | $\mu s$<br>mV                                      |
|                                                                                                                                                                                                                                                                   | All                                                                                                                                                 | $t_s$                                                    | —           | 25                                           | —            | $\mu s$                                            |

## 6A Austin MicroLynx™II: SMT Non-Isolated DC-DC Power Modules

2.4Vdc –5.5Vdc input; 0.75Vdc to 3.63Vdc output; 6A Output Current

### Electrical Specifications (continued)

| Parameter                                                                                                                                                                                                             | Device | Symbol   | Min | Typ | Max | Unit    |
|-----------------------------------------------------------------------------------------------------------------------------------------------------------------------------------------------------------------------|--------|----------|-----|-----|-----|---------|
| Dynamic Load Response<br>( $dI_o/dt=2.5A/\mu s$ ; $V_{IN} = V_{IN, nom}$ ; $T_A=25^\circ C$ )<br>Load Change from $I_o= 50\%$ to $100\%$ of $I_{o,max}$ ;<br>$C_o = 2x150 \mu F$ polymer capacitors<br>Peak Deviation | All    | $V_{pk}$ | —   | 50  | —   | mV      |
| Settling Time ( $V_o<10\%$ peak deviation)                                                                                                                                                                            | All    | $t_s$    | —   | 50  | —   | $\mu s$ |
| ( $dI_o/dt=2.5A/\mu s$ ; $V_{IN} = V_{IN, nom}$ ; $T_A=25^\circ C$ )<br>Load Change from $I_o= 100\%$ to $50\%$ of $I_{o,max}$ ;<br>$C_o = 2x150 \mu F$ polymer capacitors<br>Peak Deviation                          | All    | $V_{pk}$ | —   | 50  | —   | mV      |
| Settling Time ( $V_o<10\%$ peak deviation)                                                                                                                                                                            | All    | $t_s$    | —   | 50  | —   | $\mu s$ |

### General Specifications

| Parameter                                              | Min | Typ        | Max | Unit    |
|--------------------------------------------------------|-----|------------|-----|---------|
| Calculated MTBF ( $I_o=I_{o,max}$ , $T_A=25^\circ C$ ) |     | 12,841,800 |     | Hours   |
| Weight                                                 | —   | 2.8 (0.1)  | —   | g (oz.) |

## 6A Austin MicroLynx™II: SMT Non-Isolated DC-DC Power Modules

2.4Vdc –5.5Vdc input; 0.75Vdc to 3.63Vdc output; 6A Output Current

### Feature Specifications

Unless otherwise indicated, specifications apply over all operating input voltage, resistive load, and temperature conditions. See Feature Descriptions for additional information.

| Parameter                                                                                                                                                                                                      | Device | Symbol                            | Min  | Typ | Max                 | Unit                  |
|----------------------------------------------------------------------------------------------------------------------------------------------------------------------------------------------------------------|--------|-----------------------------------|------|-----|---------------------|-----------------------|
| On/Off Signal interface                                                                                                                                                                                        |        |                                   |      |     |                     |                       |
| Device code with Suffix "4" – Positive logic<br>(On/Off is open collector/drain logic input;<br>Signal referenced to GND - See feature description section)                                                    |        |                                   |      |     |                     |                       |
| Input High Voltage (Module ON)                                                                                                                                                                                 | All    | V <sub>IH</sub>                   | —    | —   | V <sub>IN,max</sub> | V                     |
| Input High Current                                                                                                                                                                                             | All    | I <sub>IH</sub>                   | —    | —   | 10                  | μA                    |
| Input Low Voltage (Module OFF)                                                                                                                                                                                 | All    | V <sub>IL</sub>                   | -0.2 | —   | 0.3                 | V                     |
| Input Low Current                                                                                                                                                                                              | All    | I <sub>IL</sub>                   | —    | 0.2 | 1                   | mA                    |
| Device Code with no suffix – Negative Logic<br>(On/OFF pin is open collector/drain logic input with<br>external pull-up resistor; signal referenced to GND)                                                    |        |                                   |      |     |                     |                       |
| Input High Voltage (Module OFF)                                                                                                                                                                                | All    | V <sub>IH</sub>                   | 1.5  | —   | V <sub>IN,max</sub> | Vdc                   |
| Input High Current                                                                                                                                                                                             | All    | I <sub>IH</sub>                   | —    | 0.2 | 1                   | mA                    |
| Input Low Voltage (Module ON)                                                                                                                                                                                  | All    | V <sub>IL</sub>                   | -0.2 | —   | 0.3                 | Vdc                   |
| Input low Current                                                                                                                                                                                              | All    | I <sub>IL</sub>                   | —    | —   | 10                  | μA                    |
| Turn-On Delay and Rise Times<br>(I <sub>o</sub> =I <sub>o,max</sub> , V <sub>IN</sub> = V <sub>IN,nom</sub> , T <sub>A</sub> = 25 °C, )                                                                        |        |                                   |      |     |                     |                       |
| Case 1: On/Off input is set to Logic Low (Module ON) and then input power is applied (delay from instant at which V <sub>IN</sub> =V <sub>IN,min</sub> until V <sub>o</sub> =10% of V <sub>o,set</sub> )       | All    | T <sub>delay</sub>                | —    | 3.9 | —                   | msec                  |
| Case 2: Input power is applied for at least one second and then the On/Off input is set to logic Low (delay from instant at which V <sub>on/Off</sub> =0.3V until V <sub>o</sub> =10% of V <sub>o, set</sub> ) | All    | T <sub>delay</sub>                | —    | 3.9 | —                   | msec                  |
| Output voltage Rise time (time for V <sub>o</sub> to rise from 10% of V <sub>o,set</sub> to 90% of V <sub>o, set</sub> )                                                                                       | All    | T <sub>rise</sub>                 | —    | 4.2 | 8.5                 | msec                  |
| Output voltage overshoot – Startup<br>I <sub>o</sub> = I <sub>o,max</sub> ; V <sub>IN</sub> = 3.0 to 5.5Vdc, T <sub>A</sub> = 25 °C                                                                            |        |                                   |      |     |                     |                       |
|                                                                                                                                                                                                                |        |                                   |      | —   | 1                   | % V <sub>o, set</sub> |
| Sequencing Delay time                                                                                                                                                                                          |        |                                   |      |     |                     |                       |
| Delay from V <sub>IN,min</sub> to application of voltage on SEQ pin                                                                                                                                            | All    | T <sub>SEQ-delay</sub>            | 10   |     |                     | msec                  |
| Tracking Accuracy (Power-Up: 2V/ms)                                                                                                                                                                            |        |                                   |      |     |                     |                       |
|                                                                                                                                                                                                                | All    | V <sub>SEQ</sub> – V <sub>o</sub> |      | 100 | 200                 | mV                    |
| (Power-Down: 1V/ms)                                                                                                                                                                                            |        |                                   |      |     |                     |                       |
|                                                                                                                                                                                                                | All    | V <sub>SEQ</sub> – V <sub>o</sub> |      | 200 | 400                 | mV                    |
| (V <sub>IN,min</sub> to V <sub>IN,max</sub> ; I <sub>o,min</sub> to I <sub>o,max</sub> V <sub>SEQ</sub> < V <sub>o</sub> )                                                                                     |        |                                   |      |     |                     |                       |
| Overtemperature Protection<br>(See Thermal Considerations section)                                                                                                                                             |        |                                   |      |     |                     |                       |
|                                                                                                                                                                                                                | All    | T <sub>ref</sub>                  | —    | 150 | —                   | °C                    |
| Input Undervoltage Lockout                                                                                                                                                                                     |        |                                   |      |     |                     |                       |
| Turn-on Threshold                                                                                                                                                                                              | All    |                                   |      | 2.2 |                     | V                     |
| Turn-off Threshold                                                                                                                                                                                             | All    |                                   |      | 2.0 |                     | V                     |

# 6A Austin MicroLynx™II: SMT Non-Isolated DC-DC Power Modules

2.4Vdc –5.5Vdc input; 0.75Vdc to 3.63Vdc output; 6A Output Current

## Characteristic Curves

The following figures provide typical characteristics for the Austin MicroLynx™ II SMT modules at 25°C.

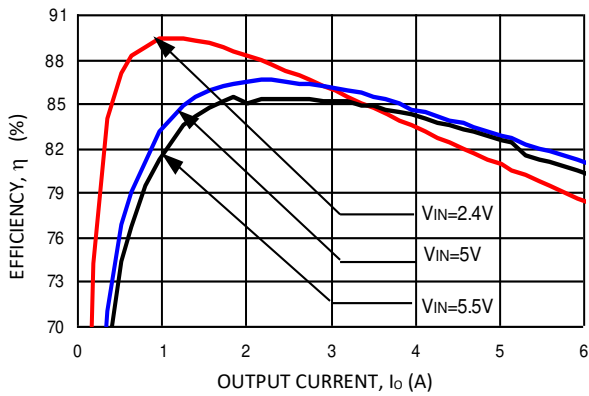

Figure 1. Converter Efficiency versus Output Current (Vout = 0.75Vdc).

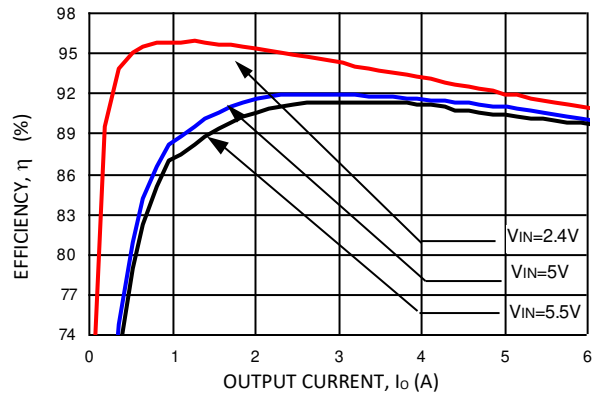

Figure 4. Converter Efficiency versus Output Current (Vout = 1.8Vdc).

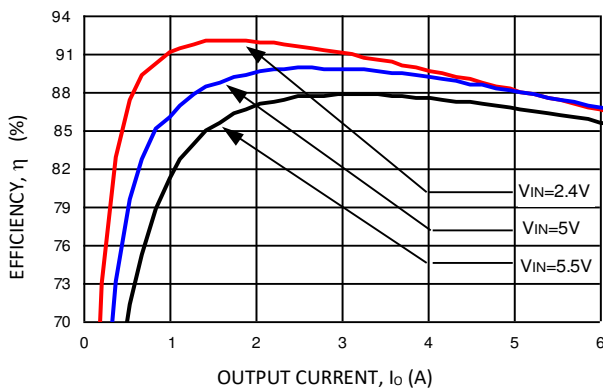

Figure 2. Converter Efficiency versus Output Current (Vout = 1.2Vdc).

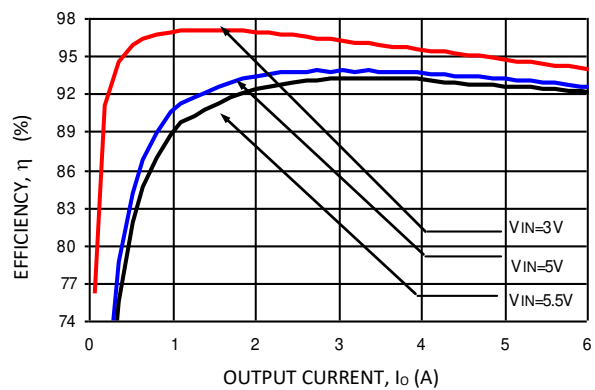

Figure 5. Converter Efficiency versus Output Current (Vout = 2.5Vdc).

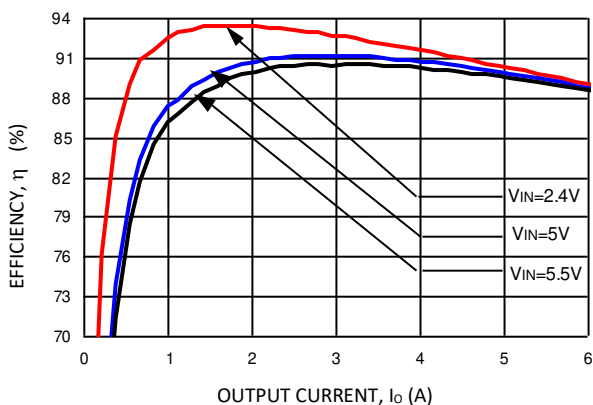

Figure 3. Converter Efficiency versus Output Current (Vout = 1.5Vdc).

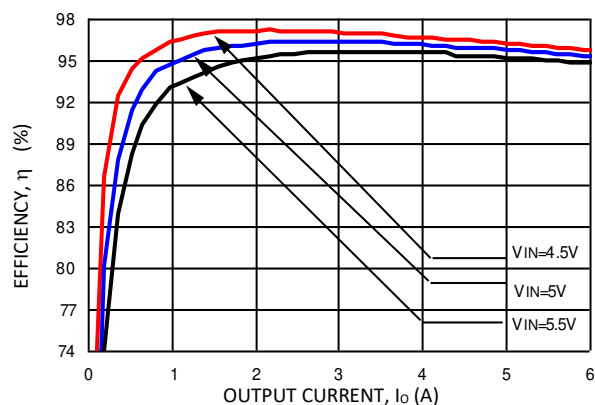

Figure 6. Converter Efficiency versus Output Current (Vout = 3.3Vdc).

# 6A Austin MicroLynx™II: SMT Non-Isolated DC-DC Power Modules

2.4Vdc –5.5Vdc input; 0.75Vdc to 3.63Vdc output; 6A Output Current

## Characteristic Curves (continued)

The following figures provide typical characteristics for the MicroLynx™ II SMT modules at 25°C.

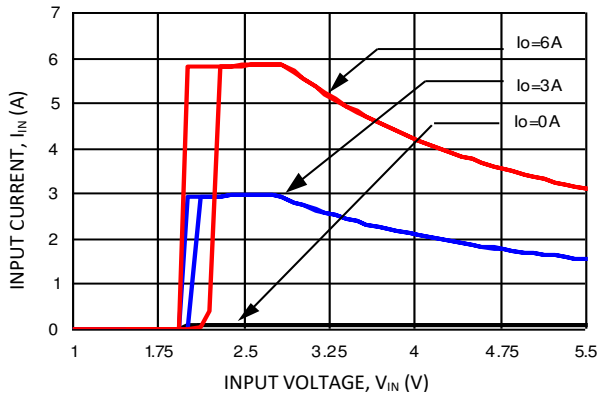

**Figure 7. Input voltage vs. Input Current**  
( $V_{out} = 2.5Vdc$ ).

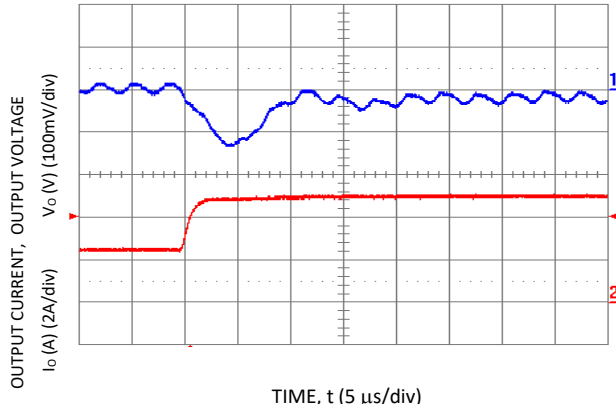

**Figure 10. Transient Response to Dynamic Load Change from 50% to 100% of full load** ( $V_o = 3.3Vdc$ ).

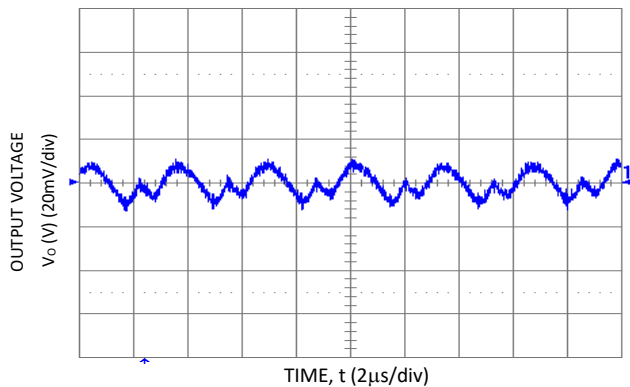

**Figure 8. Typical Output Ripple and Noise**  
( $V_{in} = 5.0V dc$ ,  $V_o = 0.75 Vdc$ ,  $I_o = 6A$ ).

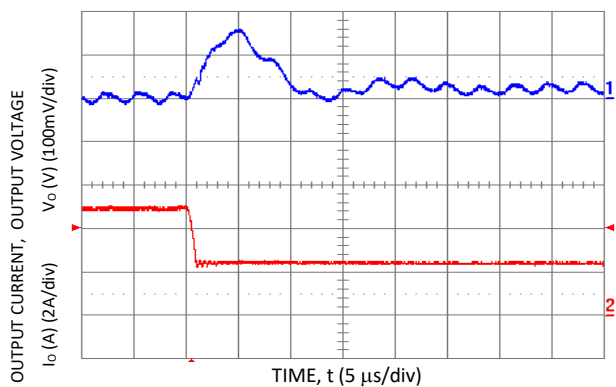

**Figure 11. Transient Response to Dynamic Load Change from 100% to 50% of full load** ( $V_o = 3.3 Vdc$ ).

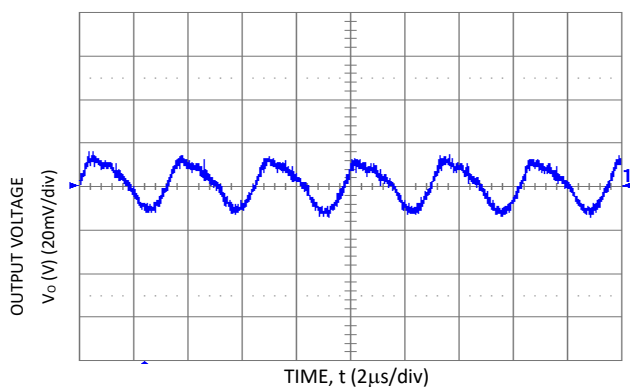

**Figure 9. Typical Output Ripple and Noise**  
( $V_{in} = 5.0V dc$ ,  $V_o = 3.3 Vdc$ ,  $I_o = 6A$ ).

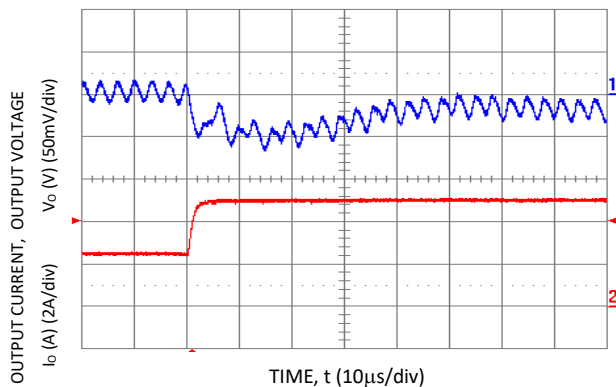

**Figure 12. Transient Response to Dynamic Load Change from 50% to 100% of full load** ( $V_o = 3.3 Vdc$ ,  $C_{ext} = 2 \times 150 \mu F$  Polymer Capacitors).

# 6A Austin MicroLynx™II: SMT Non-Isolated DC-DC Power Modules

2.4Vdc –5.5Vdc input; 0.75Vdc to 3.63Vdc output; 6A Output Current

## Characteristic Curves (continued)

The following figures provide typical characteristics for the Austin MicroLynx™ II SMT modules at 25°C.

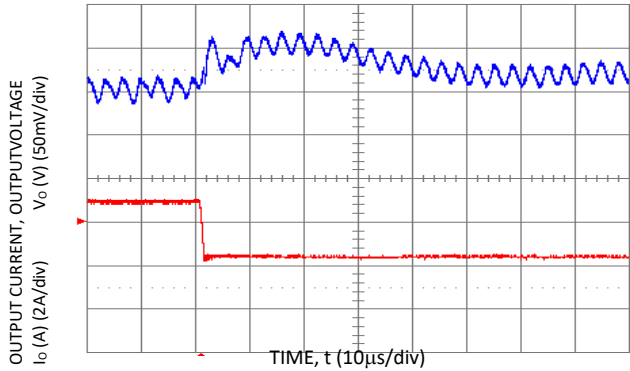

**Figure 13. Transient Response to Dynamic Load Change from 100% of full load ( $V_o = 3.3Vdc$ ,  $C_{ext} = 2 \times 150 \mu F$  Polymer Capacitors).**

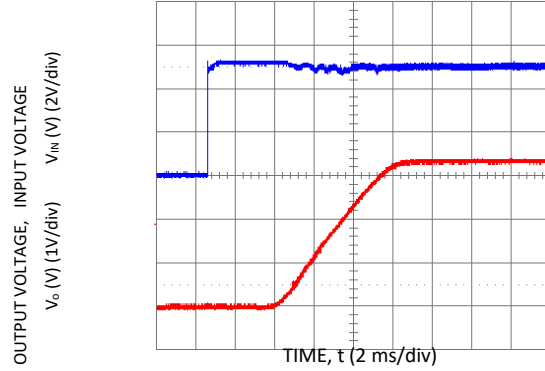

**Figure 16. Typical Start-Up with application of  $V_{in}$  ( $V_{in} = 5.0Vdc$ ,  $V_o = 3.3Vdc$ ,  $I_o = 6A$ ).**

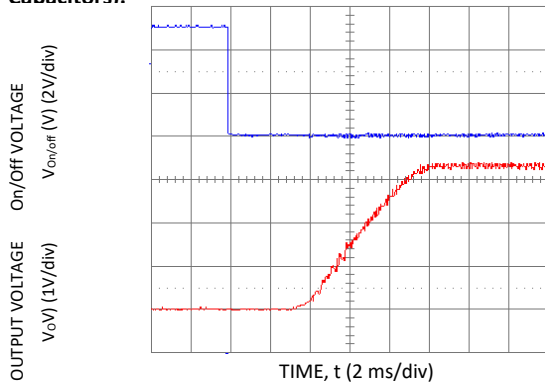

**Figure 14. Typical Start-Up Using Remote On/Off ( $V_{in} = 5.0Vdc$ ,  $V_o = 3.3Vdc$ ,  $I_o = 6A$ ).**

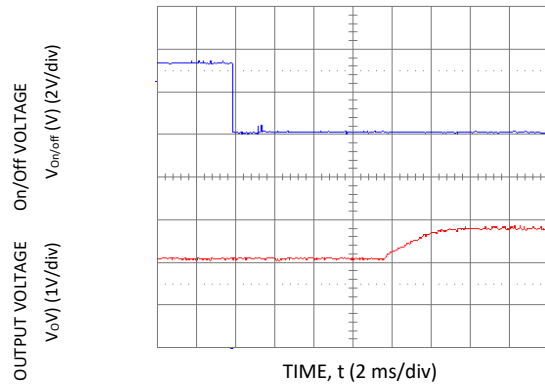

**Figure 17 Typical Start-Up Using Remote On/Off with Prebias ( $V_{in} = 3.3Vdc$ ,  $V_o = 1.8Vdc$ ,  $I_o = 1.0A$ ,  $V_{bias} = 1.0Vdc$ ).**

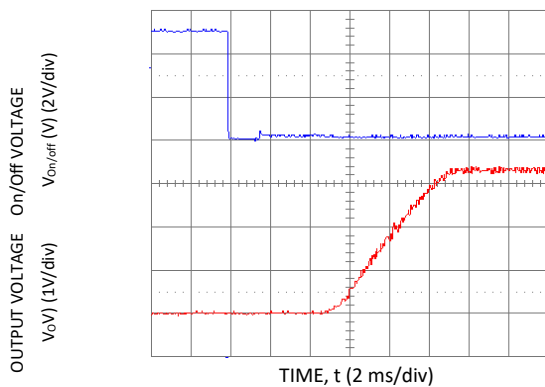

**Figure 15. Typical Start-Up Using Remote On/Off with Low-ESR external capacitors ( $7 \times 150 \mu F$  Polymer) ( $V_{in} = 5.0Vdc$ ,  $V_o = 3.3Vdc$ ,  $I_o = 6A$ ,  $C_o = 1050 \mu F$ ).**

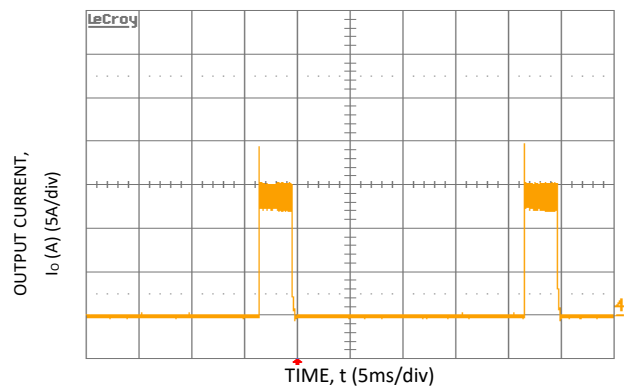

**Figure 18. Output short circuit Current ( $V_{in} = 5.0Vdc$ ,  $V_o = 0.75Vdc$ ).**



# 6A Austin MicroLynx™II: SMT Non-Isolated DC-DC Power Modules

2.4Vdc –5.5Vdc input; 0.75Vdc to 3.63Vdc output; 6A Output Current

## Characteristic Curves (continued)

The following figures provide thermal derating curves for the Austin MicroLynx™ II SMT modules.

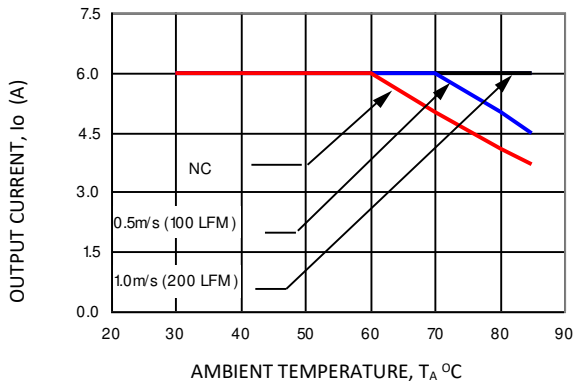

Figure 19. Derating Output Current versus Local Ambient Temperature and Airflow (Vin = 5.0, Vo=3.3Vdc).

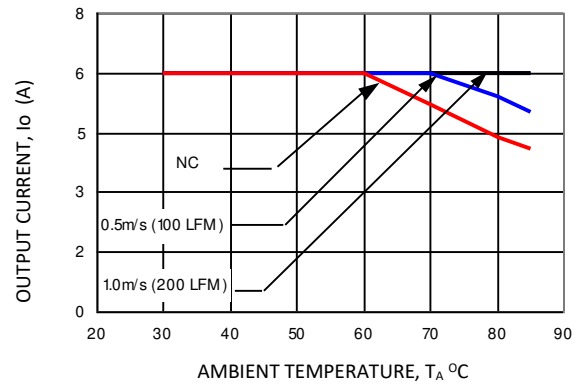

Figure 22. Derating Output Current versus Local Ambient Temperature and Airflow (Vin = 3.3dc, Vo=0.75 Vdc).

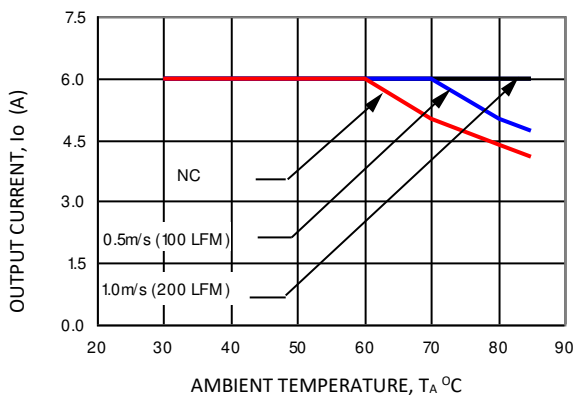

Figure 20. Derating Output Current versus Local Ambient Temperature and Airflow (Vin = 5.0Vdc, Vo=0.75 Vdc).

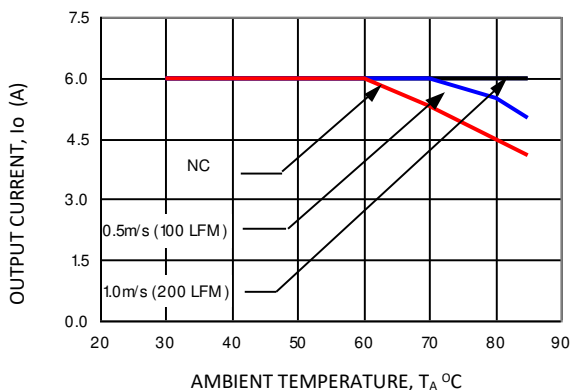
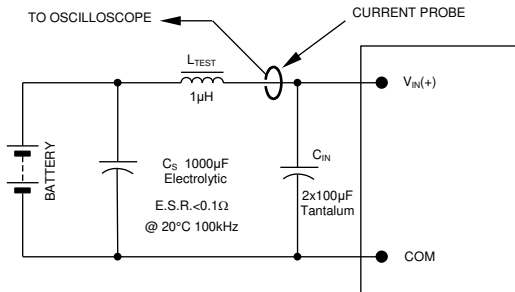

Figure 21. Derating Output Current versus Local Ambient Temperature and Airflow (Vin = 3.3Vdc, Vo=2.5 Vdc).

# 6A Austin MicroLynx™II: SMT Non-Isolated DC-DC Power Modules

2.4Vdc –5.5Vdc input; 0.75Vdc to 3.63Vdc output; 6A Output Current

## Test Configurations



NOTE: Measure input reflected ripple current with a simulated source inductance ( $L_{TEST}$ ) of 1µH. Capacitor  $C_S$  offsets possible battery impedance. Measure current as shown above.

Figure 23. Input Reflected Ripple Current Test Setup.

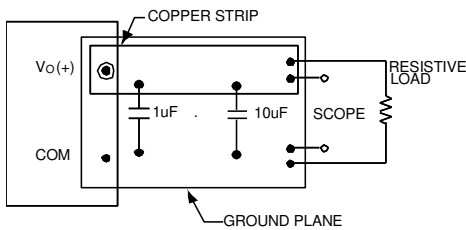

NOTE: All voltage measurements to be taken at the module terminals, as shown above. If sockets are used then Kelvin connections are required at the module terminals to avoid measurement errors due to socket contact resistance.

Figure 24. Output Ripple and Noise Test Setup.

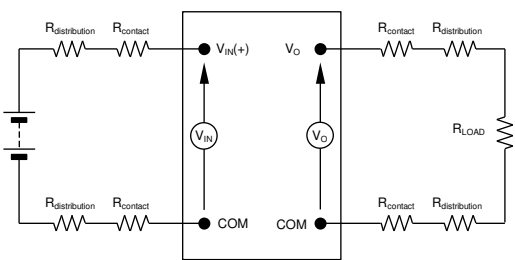

NOTE: All voltage measurements to be taken at the module terminals, as shown above. If sockets are used then Kelvin connections are required at the module terminals to avoid measurement errors due to socket contact resistance.

Figure 25. Output Voltage and Efficiency Test Setup.

$$\text{Efficiency } \eta = \frac{V_O \cdot I_O}{V_{IN} \cdot I_{IN}} \times 100 \%$$

## Design Considerations

### Input Filtering

The Austin MicroLynx™ II SMT module should be connected to a low-impedance source. A highly inductive source can affect the stability of the module. An input capacitance must be placed directly adjacent to the input pin of the module, to minimize input ripple voltage and ensure module stability.

To minimize input voltage ripple, low-ESR polymer and ceramic capacitors are recommended at the input of the module. Figure 26 shows the input ripple voltage (mVp-p) for various outputs with 1x150 µF polymer capacitors (Panasonic p/n: EEFUE0J151R, Sanyo p/n: 6TPE150M) in parallel with 1 x 47 µF ceramic capacitor (Panasonic p/n: ECJ-5YB0J476M, Taiyo- Yuden p/n: CEJMK432BJ476MMT) at full load. Figure 27 shows the input ripple with 2x150 µF polymer capacitors in parallel with 2 x 47 µF ceramic capacitor at full load.

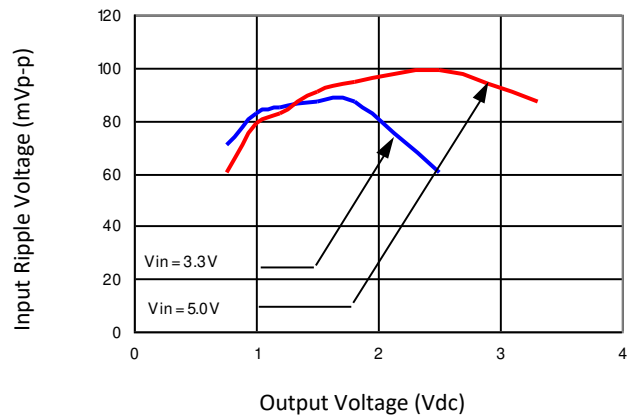

Figure 26. Input ripple voltage for various output with 1x150 µF polymer and 1x47 µF ceramic capacitors at the input (80% of  $I_{O,max}$ ).

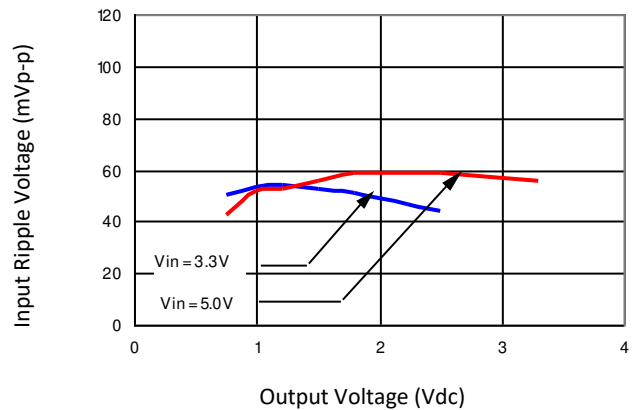

Figure 27. Input ripple voltage for various output with 2x150 µF polymer and 2x47 µF ceramic capacitors at the input (80% of  $I_{O,max}$ ).

## 6A Austin MicroLynx™II: SMT Non-Isolated DC-DC Power Modules

2.4Vdc –5.5Vdc input; 0.75Vdc to 3.63Vdc output; 6A Output Current

### Design Considerations (continued)

#### Output Filtering

The Austin MicroLynx™ II SMT module is designed for low output ripple voltage and will meet the maximum output ripple specification with 1  $\mu$ F ceramic and 10  $\mu$ F tantalum capacitors at the output of the module. However, additional output filtering may be required by the system designer for a number of reasons. First, there may be a need to further reduce the output ripple and noise of the module. Second, the dynamic response characteristics may need to be customized to a particular load step change.

To reduce the output ripple and improve the dynamic response to a step load change, additional capacitance at the output can be used. Low ESR polymer and ceramic capacitors are recommended to improve the dynamic response of the module. For stable operation of the module, limit the capacitance to less than the maximum output capacitance as specified in the electrical specification table.

### Safety Considerations

For safety agency approval the power module must be installed in compliance with the spacing and separation requirements of the end-use safety agency standards, i.e., UL ANSI/UL 62368-1 and CAN/CSA C22.2 No. 62368-1 Recognized, DIN VDE 0868-1/A11:2017 (EN62368-1:2014/A11:2017).

For the converter output to be considered meeting the Requirements of safety extra-low voltage (SELV) or ES1, the input must meet SELV/ES1 requirements. The power module has extra-low voltage (ELV) outputs when all inputs are ELV.

The input to these units is to be provided with a fast-acting fuse with a maximum rating of 6A in the positive input lead.

# 6A Austin MicroLynx™II: SMT Non-Isolated DC-DC Power Modules

2.4Vdc –5.5Vdc input; 0.75Vdc to 3.63Vdc output; 6A Output Current

## Feature Description

### Remote On/Off

The Austin Lynx™ II SMT power modules feature an On/Off pin for remote On/Off operation. Two On/Off logic options are available in the Austin Lynx™ II series modules. Positive Logic On/Off signal, device code suffix “4”, turns the module ON during a logic High on the On/Off pin and turns the module OFF during a logic Low. Negative logic On/Off signal, no device code suffix, turns the module OFF during logic High on the On/Off pin and turns the module ON during logic Low.

For positive logic modules, the circuit configuration for using the On/Off pin is shown in Figure 28. The On/Off pin is an open collector/drain logic input signal ( $V_{ON/OFF}$ ) that is referenced to ground. During a logic-high (On/Off pin is pulled high internal to the module) when the transistor Q1 is in the Off state, the power module is ON. Maximum allowable leakage current of the transistor when  $V_{on/off} = V_{IN,max}$  is 10 $\mu$ A. Applying a logic-low when the transistor Q1 is turned-On, the power module is OFF. During this state  $V_{On/Off}$  must be less than 0.3V. When not using positive logic On/off pin, leave the pin unconnected or tie to  $V_{IN}$ .

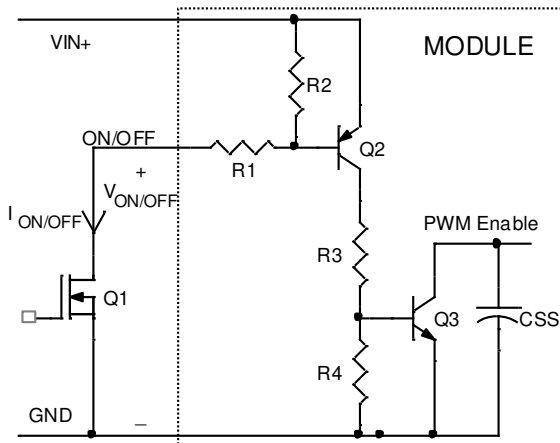

Figure 28. Circuit configuration for using positive logic On/Off.

For negative logic On/Off devices, the circuit configuration is shown in Figure 29. The On/Off pin is pulled high with an external pull-up resistor (typical  $R_{pull-up} = 5k, +/- 5%$ ). When transistor Q1 is in the Off state, logic High is applied to the On/Off pin and the power module is Off. The minimum On/off voltage for logic High on the On/Off pin is 1.5Vdc. To turn the module ON, logic Low is applied to the On/Off pin by turning ON Q1. When not using the negative logic On/Off, leave the pin unconnected or tie to GND.

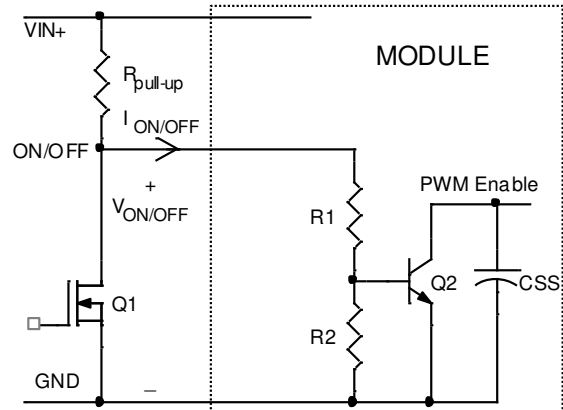

Figure 29. Circuit configuration for using negative logic On/Off.

### Overcurrent Protection

To provide protection in a fault (output overload) condition, the unit is equipped with internal current-limiting circuitry and can endure current limiting continuously. At the point of current-limit inception, the unit enters hiccup mode. The unit operates normally once the output current is brought back into its specified range. The typical average output current during hiccup is 2A.

### Input Undervoltage Lockout

At input voltages below the input undervoltage lockout limit, module operation is disabled. The module will begin to operate at an input voltage above the undervoltage lockout turn-on threshold.

### Overtemperature Protection

To provide over temperature protection in a fault condition, the unit relies upon the thermal protection feature of the controller IC. The unit will shutdown if the thermal reference point  $T_{ref}$ , exceeds 150°C (typical), but the thermal shutdown is not intended as a guarantee that the unit will survive temperatures beyond its rating. The module will automatically restart after it cools down.

# 6A Austin MicroLynx™II: SMT Non-Isolated DC-DC Power Modules

2.4Vdc –5.5Vdc input; 0.75Vdc to 3.63Vdc output; 6A Output Current

## Feature Descriptions (continued)

### Output Voltage Programming

The output voltage of the Austin MicroLynx™ II SMT can be programmed to any voltage from 0.75 Vdc to 3.63 Vdc by connecting a single resistor (shown as  $R_{trim}$  in Figure 30) between the TRIM and GND pins of the module. Without an external resistor between TRIM pin and the ground, the output voltage of the module is 0.7525 Vdc. To calculate the value of the resistor  $R_{trim}$  for a particular output voltage  $V_o$ , use the following equation:

$$R_{trim} = \left[ \frac{21070}{V_o - 0.7525} - 5110 \right] \Omega$$

For example, to program the output voltage of the Austin MicroLynx™ II module to 1.8 Vdc,  $R_{trim}$  is calculated as follows:

$$R_{trim} = \left[ \frac{21070}{1.8 - 0.7525} - 5110 \right]$$

$$R_{trim} = 15.004k\Omega$$

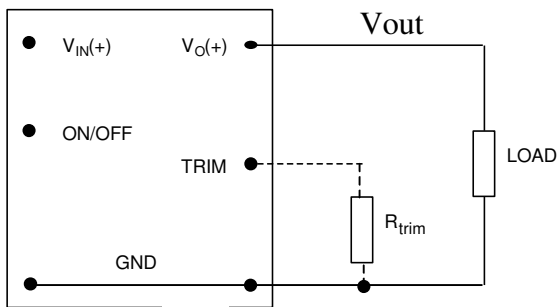

Figure 30. Circuit configuration to program output voltage using an external resistor.

Table 1 provides  $R_{trim}$  values required for some common output voltages.

Table 1

| $V_{o, set}$ (V) | $R_{trim}$ (kΩ) |
|------------------|-----------------|
| 0.7525           | Open            |
| 1.2              | 41.973          |
| 1.5              | 23.077          |
| 1.8              | 15.004          |
| 2.5              | 6.947           |
| 3.3              | 3.160           |

By using a 1% tolerance trim resistor, set point tolerance of  $\pm 2\%$  is achieved as specified in the electrical specification. The POL Programming Tool, available at [www.gecriticalpower.com](http://www.gecriticalpower.com)

under the Design Tools section, helps determine the required external trim resistor needed for a specific output voltage.

### Voltage Margining

Output voltage margining can be implemented in the Austin MicroLynx™ II modules by connecting a resistor,  $R_{margin-up}$ , from the Trim pin to the ground pin for margining-up the output voltage and by connecting a resistor,  $R_{margin-down}$ , from the Trim pin to the Output pin for margining-down. Figure 31 shows the circuit configuration for output voltage margining. The POL Programming Tool, available at [www.gecriticalpower.com](http://www.gecriticalpower.com) under the Design Tools section, also calculates the values of  $R_{margin-up}$  and  $R_{margin-down}$  for a specific output voltage and % margin. Please consult your local GE technical representative for additional details.

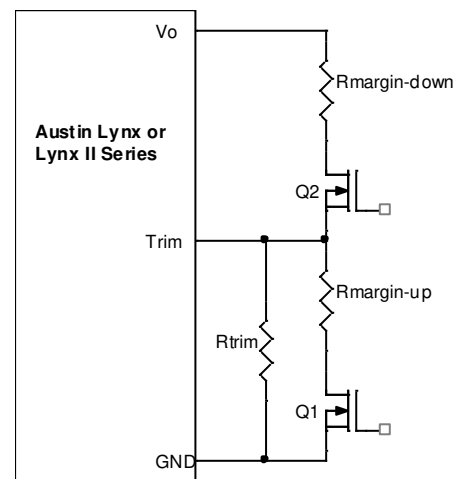

Figure 31. Circuit Configuration for margining Output voltage.

## 6A Austin MicroLynx™II: SMT Non-Isolated DC-DC Power Modules

2.4Vdc –5.5Vdc input; 0.75Vdc to 3.63Vdc output; 6A Output Current

### Feature Descriptions (continued)

#### Voltage Sequencing

Austin MicroLynx™ II series of modules include a sequencing feature, EZ-SEQUENCE™ that enables users to implement various types of output voltage sequencing in their applications. This is accomplished via an additional sequencing pin. When not using the sequencing feature, either tie the SEQ pin to  $V_{IN}$  or leave it unconnected.

When an analog voltage is applied to the SEQ pin, the output voltage tracks this voltage until the output reaches the set-point voltage. The SEQ voltage must be set higher than the set-point voltage of the module. The output voltage follows the voltage on the SEQ pin on a one-to-one volt basis. By connecting multiple modules together, customers can get multiple modules to track their output voltages to the voltage applied on the SEQ pin.

For proper voltage sequencing, first, input voltage is applied to the module. The On/Off pin of the module is left unconnected (or tied to GND for negative logic modules or tied to  $V_{IN}$  for positive logic modules) so that the module is ON by default. After applying input voltage to the module, a minimum of 10msec delay is required before applying voltage on the SEQ pin. During this time, potential of 50mV ( $\pm 10$  mV) is maintained on the SEQ pin. After 10msec delay, an analog voltage is applied to the SEQ pin and the output voltage of the module will track this voltage on a one-to-one volt bases until output reaches the set-point voltage. To initiate simultaneous shutdown of the modules, the SEQ pin voltage is lowered in a controlled manner. Output voltage of the modules tracks the voltages below their set-point voltages on a one-to-one basis. A valid input voltage must be maintained until the tracking and output voltages reach ground potential to ensure a controlled shutdown of the modules.

When using the EZ-SEQUENCE™ feature to control start-up of the module, pre-bias immunity feature during start-up is disabled. The pre-bias immunity feature of the module relies on the module being in the diode-mode during start-up. When using the EZ-SEQUENCE™ feature, modules goes through an internal set-up time of 10msec, and will be in synchronous rectification mode when voltage at the SEQ pin is applied. This will result in sinking current in the module if pre-bias voltage is present at the output of the module. When pre-bias immunity during start-up is required, the EZ-SEQUENCE™ feature must be disabled. For additional guidelines on using EZ-SEQUENCE™ feature of Austin MicroLynx™ II, contact GE technical representative for preliminary application note on output voltage sequencing using Austin Lynx II series.

# 6A Austin MicroLynx™II: SMT Non-Isolated DC-DC Power Modules

2.4Vdc –5.5Vdc input; 0.75Vdc to 3.63Vdc output; 6A Output Current

## Thermal Considerations

Power modules operate in a variety of thermal environments; however, sufficient cooling should be provided to help ensure reliable operation.

Considerations include ambient temperature, airflow, module power dissipation, and the need for increased reliability. A reduction in the operating temperature of the module will result in an increase in reliability. The thermal data presented here is based on physical measurements taken in a wind tunnel. The test set-up is shown in Figure 33. Note that the airflow is parallel to the long axis of the module as shown in figure 32. The derating data applies to airflow in either direction of the module’s long axis.

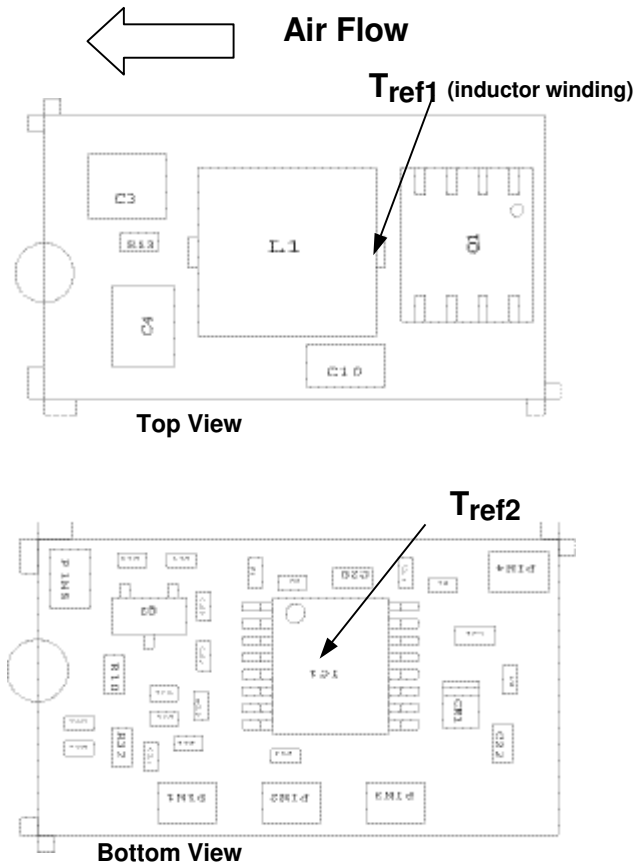

Figure 32. Tref Temperature measurement location.

The thermal reference point,  $T_{ref1}$  used in the specifications of thermal derating curves is shown in Figure 32. For reliable operation this temperature should not exceed 125°C.

The output power of the module should not exceed the rated power of the module ( $V_{o,set} \times I_{o,max}$ ).

Please refer to the Application Note “Thermal Characterization Process For Open-Frame Board-Mounted Power Modules” for a detailed discussion of thermal aspects including maximum device temperatures.

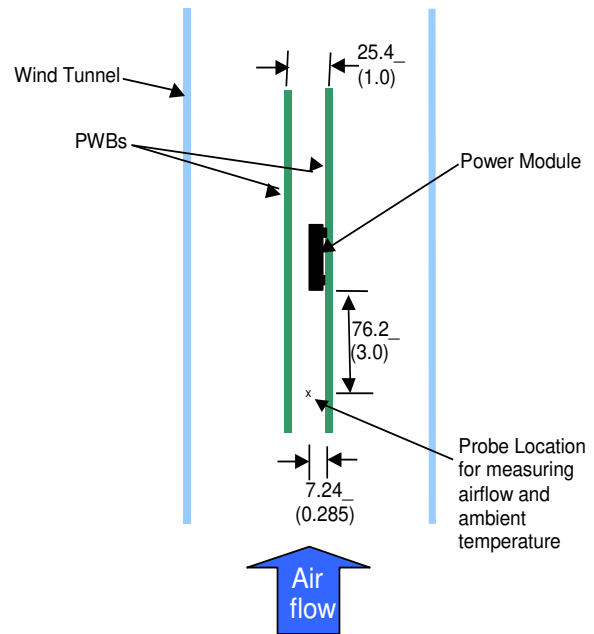

Figure 33. Thermal Test Set-up.

## Heat Transfer via Convection

Increased airflow over the module enhances the heat transfer via convection. Thermal derating curves showing the maximum output current that can be delivered by various module versus local ambient temperature ( $T_A$ ) for natural convection and up to 1m/s (200 ft./min) are shown in the Characteristics Curves section.

# 6A Austin MicroLynx™II: SMT Non-Isolated DC-DC Power Modules

2.4Vdc –5.5Vdc input; 0.75Vdc to 3.63Vdc output; 6A Output Current

## Mechanical Outline

Dimensions are in millimeters and (inches).

Tolerances: x.x mm ± 0.5 mm (x.xx in. ± 0.02 in.) [unless otherwise indicated]

x.xx mm ± 0.25 mm (x.xxx in ± 0.010 in.)

Top View

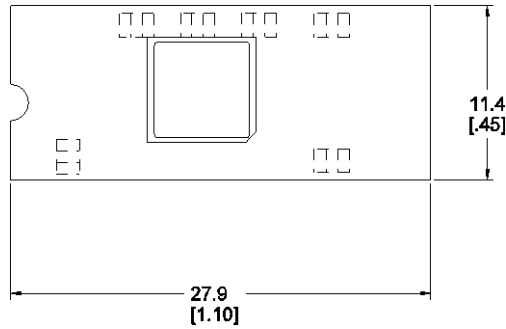

Side View

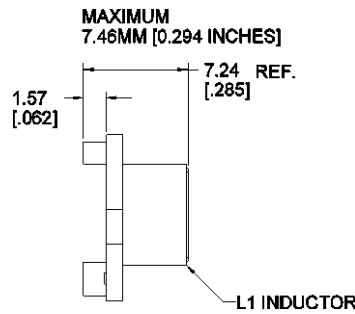

Bottom View

| PIN | FUNCTION         |
|-----|------------------|
| 1   | On/Off           |
| 2   | V <sub>IN</sub>  |
| 3   | SEQ              |
| 4   | GND              |
| 5   | Trim             |
| 6   | V <sub>OUT</sub> |

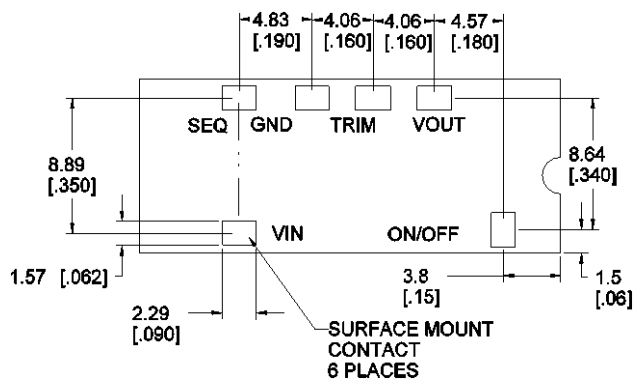

Co-planarity (max): 0.102 [0.004]



## 6A Austin MicroLynx™II: SMT Non-Isolated DC-DC Power Modules

2.4Vdc –5.5Vdc input; 0.75Vdc to 3.63Vdc output; 6A Output Current

### Recommended Pad Layout

Dimensions are in millimeters and (inches).

Tolerances: x.x mm ± 0.5 mm (x.xx in. ± 0.02 in.) [unless otherwise indicated]

x.xx mm ± 0.25 mm (x.xxx in ± 0.010 in.)

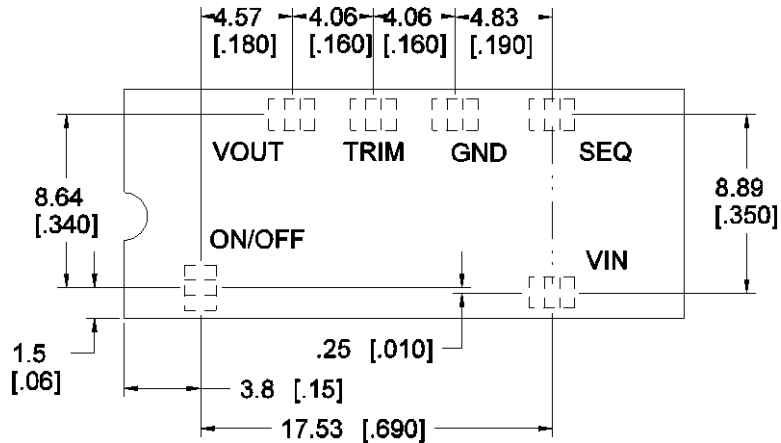

**PAD SIZE:**  
**MIN: 3.05MM X 2.41MM [0.120" X 0.095"]**  
**MAX: 3.43MM X 2.79MM [0.135" X 0.110"]**

Surface Mount Pad Layout – Component side view.

# 6A Austin MicroLynx™II: SMT Non-Isolated DC-DC Power Modules

2.4Vdc –5.5Vdc input; 0.75Vdc to 3.63Vdc output; 6A Output Current

## Packaging Details

The Austin MicroLynx™ II SMT versions are supplied in tape & reel as standard. Modules are shipped in quantities of 400 modules per reel.

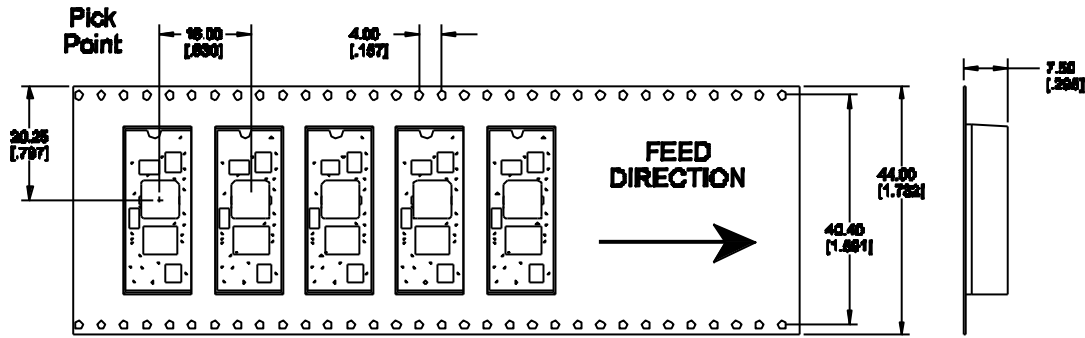

### Surface Mount Tape & Reel

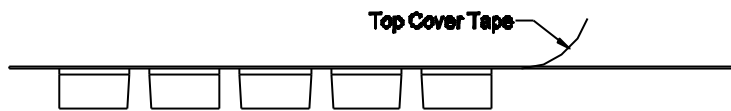

All Dimensions are in millimeters and (in inches).

#### Reel Dimensions

Outside Dimensions: 330.2 mm (13.00)

Inside Dimensions: 177.8 mm (7.00")

Width 44.0 mm (1.73")

## 6A Austin MicroLynx™II: SMT Non-Isolated DC-DC Power Modules

2.4Vdc –5.5Vdc input; 0.75Vdc to 3.63Vdc output; 6A Output Current

### Surface Mount Information

#### Pick and Place

The Austin MicroLynx™ II SMT modules use an open frame construction and are designed for a fully automated assembly process. The modules are fitted with a label designed to provide a large surface area for pick and placing. The label meets all the requirements for surface mount processing, as well as safety standards and is able to withstand maximum reflow temperature. The label also carries product information such as product code, serial number and location of manufacture.

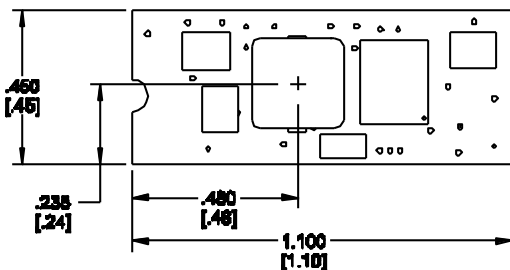

Figure 34. Pick and Place Location.

#### Nozzle Recommendations

The module weight has been kept to a minimum by using open frame construction. Even so, these modules have a relatively large mass when compared to conventional SMT components. Variables such as nozzle size, tip style, vacuum pressure and pick & placement speed should be considered to optimize this process. The minimum recommended nozzle diameter for reliable operation is 3mm. The maximum nozzle outer diameter, which will safely fit within the allowable component spacing, is 8 mm max.

#### Tin Lead Soldering

The Austin MicroLynx™ II SMT power modules are lead free modules and can be soldered either in a lead-free solder process or in a conventional Tin/Lead (Sn/Pb) process. It is recommended that the customer review data sheets in order to customize the solder reflow profile for each application board assembly. The following instructions must be observed when soldering these units. Failure to observe these instructions may result in the failure of or cause damage to the modules, and can adversely affect long-term reliability.

In a conventional Tin/Lead (Sn/Pb) solder process peak reflow temperatures are limited to less than 235°C. Typically, the eutectic solder melts at 183°C, wets the land, and subsequently wicks the device connection. Sufficient time must be allowed to fuse the plating on the connection to ensure a reliable solder joint. There are several types of SMT reflow technologies currently used in the industry. These surface mount power modules can be reliably soldered using

natural forced convection, IR (radiant infrared), or a combination of convection/IR. For reliable soldering the solder reflow profile should be established by accurately measuring the modules CP connector temperatures.

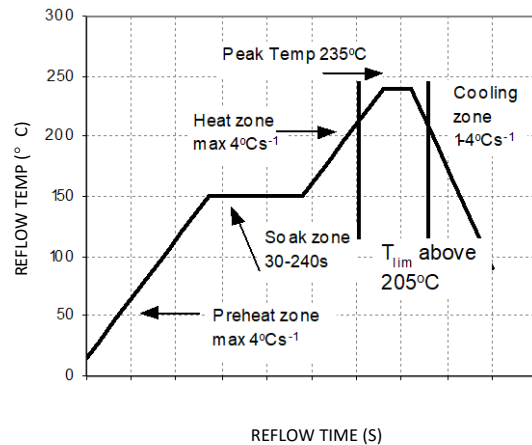

Figure 35. Reflow Profile for Tin/Lead (Sn/Pb) process.

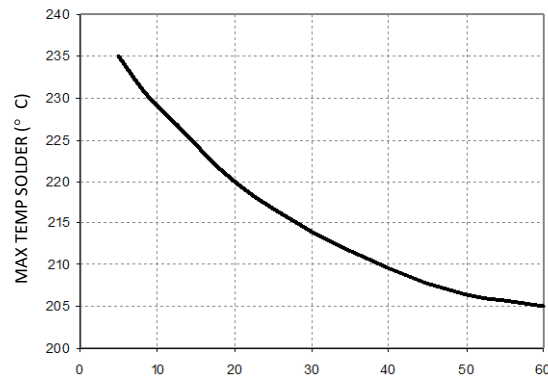

Figure 36. Time Limit Curve Above 205°C for Tin/Lead (Sn/Pb) process.

## 6A Austin MicroLynx™II: SMT Non-Isolated DC-DC Power Modules

2.4Vdc –5.5Vdc input; 0.75Vdc to 3.63Vdc output; 6A Output Current

### Surface Mount Information (continued)

#### Lead Free Soldering

The –Z version Austin MicroLynx II SMT modules are lead-free (Pb-free) and RoHS compliant and are both forward and backward compatible in a Pb-free and a SnPb soldering process. Failure to observe the instructions below may result in the failure of or cause damage to the modules and can adversely affect long-term reliability.

#### Pb-free Reflow Profile

Power Systems will comply with J-STD-020 Rev. D (Moisture/Reflow Sensitivity Classification for Nonhermetic Solid State Surface Mount Devices) for both Pb solder profiles and MSL classification procedures. This standard provides a recommended forced-air-convection reflow profile based on the volume and thickness of the package (table 4-2). The suggested Pb-free solder paste is Sn/Ag/Cu (SAC). The recommended linear reflow profile using Sn/Ag/Cu solder is shown in Figure. 37.

#### MSL Rating

The Austin MicroLynx II modules have a MSL rating of 2a.

#### Storage and Handling

The recommended storage environment and handling procedures for moisture-sensitive surface mount packages is detailed in J-STD-033 Rev. A (Handling, Packing, Shipping and Use of Moisture/Reflow Sensitive Surface Mount Devices). Moisture barrier bags (MBB) with desiccant are required for MSL ratings of 2 or greater. These sealed packages should not be broken until time of use. Once the original package is broken, the floor life of the product at conditions of  $\leq 30^{\circ}\text{C}$  and 60% relative humidity varies according to the MSL rating (see J-STD-033A). The shelf life for dry packed SMT packages will be a minimum of 12 months from the bag seal date, when stored at the following conditions:  $< 40^{\circ}\text{C}$ ,  $< 90\%$  relative humidity.

#### Post Solder Cleaning and Drying Considerations

Post solder cleaning is usually the final circuit-board assembly process prior to electrical board testing. The result of inadequate cleaning and drying can affect both the reliability of a power module and the testability of the finished circuit-board assembly. For guidance on appropriate soldering, cleaning and drying procedures, refer to *Board Mounted Power Modules: Soldering and Cleaning* Application Note (AN04-001).

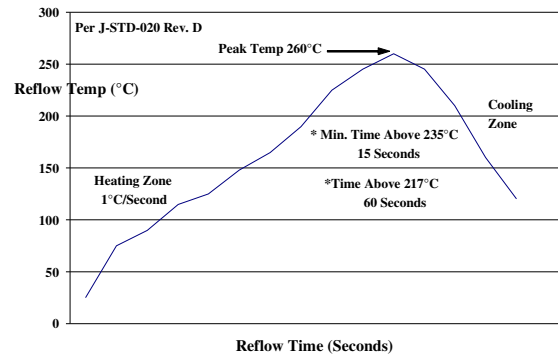

Figure 37. Recommended linear reflow profile using Sn/Ag/Cu solder.

## 6A Austin MicroLynx™II: SMT Non-Isolated DC-DC Power Modules

2.4Vdc –5.5Vdc input; 0.75Vdc to 3.63Vdc output; 6A Output Current

### Ordering Information

Please contact your GE Sales Representative for pricing, availability and optional features.

**Table 2. Device Codes**

| Device Code    | Input Voltage Range | Output Voltage | Output Current | Efficiency 3.3V@ 6A | On/Off Logic | Connector Type | Comcodes    |
|----------------|---------------------|----------------|----------------|---------------------|--------------|----------------|-------------|
| ATH006A0X-SRZ  | 2.4 – 5.5Vdc        | 0.75 – 3.63Vdc | 6 A            | 96.0%               | Negative     | SMT            | CC109104535 |
| ATH006A0X4-SRZ | 2.4 – 5.5Vdc        | 0.75 – 3.63Vdc | 6 A            | 96.0%               | Positive     | SMT            | 108996708   |

-Z refers to RoHS compliant parts



### Contact Us

For more information, call us at

USA/Canada:

**+1 877 546 3243**, or +1 972 244 9288

Asia-Pacific:

**+86-21-53899666**

Europe, Middle-East and Africa:

**+49.89.878067-280**

**Go.ABB/Industrial**

GE Critical Power reserves the right to make changes to the product(s) or information contained herein without notice, and no liability is assumed as a result of their use or application. No rights under any patent accompany the sale of any such product(s) or information.