

DATASHEET

EVERLIGHT

EVERLIGHT  
EVERLIGHT

## ELUC3535NUB 0.13 W Series



### Introduction

The ELUC3535NUB product series is a ceramic based LED with high quality and reliability that suitable for UV application.

### Features

- ◆ High power UVC LED
- ◆ Dimension 3.5mm\* 3.5mm\* 1.3mm
- ◆ ESD protection up to 2KV
- ◆ Typical viewing angle: 120°
- ◆ RoHS compliant
- ◆ Pb free
- ◆ Compliance with EU REACH
- ◆ Compliance Halogen Free  
(Br<900ppm,Cl<900ppm,Br+Cl<1500ppm)

### Applications

- ◆ UV Sterilization

## Product Nomenclature

### ELUC3535NUB-P7085Q05075020-S21Q

EL = Everlight

UC = UVC

3535 = 3.5mm x 3.5mm Package

N = Package Material: AlN

U = Coating: Au

B = Angle: 120°

P = Peak Wavelength

7085= Wavelength Range: 270~285nm

Q0 = Minimum Radiant Flux Spec: 1mW

5075 = Forward Voltage Spec: 5.0~7.5V

020= Forward Current: 20mA

S = Chip Type: Submount

2 = Chip Size: 20 mil

1 = Chip QTY: 1 chip

Q = Process Type: Quartz Glass

### Absolute Maximum Ratings

Parameter	Symbol	Ratings	Unit
Max. DC Forward Current (mA)	I <sub>F</sub>	40	mA
Max. ESD Resistance	V <sub>B</sub>	2000	V
Max. Junction Temperature	T <sub>J</sub>	70	°C
Thermal Resistance	R <sub>th</sub>	65	°C/W
Operating Temperature	T <sub>Opr</sub>	-30 ~ +60	°C
Storage Temperature	T <sub>Stg</sub>	-40 ~ +100	°C

### PN of the ELUC3535NUB series: UVC LEDs

Order Code of ELUC3535NUB	Minimum Radiant Flux (mW)	Typical Radiant Flux (mW)	Maximum Radiant Flux (mW)	Peak Wavelength (nm)	Forward Voltage (V)	Forward Current (mA)
ELUC3535NUB-P7085Q05075 020-S21Q	1	2	2.5	270-285	5.0-7.5	20

## Product Binning

### Radiant Flux Bins

Bin Code	Minimum Radiant Flux (mW)	Maximum Radiant Flux (mW)
Q0A	1	1.5
Q0B	1.5	2
Q0C	2	2.5

#### Notes:

1. Radiant flux measurement tolerance:  $\pm 10\%$ .
2. Forward voltage bins are defined at  $I_f=20\text{mA}$  operation.

### Peak Wavelength Bins

Bin Code	Minimum Peak Wavelength (nm)	Maximum Peak Wavelength (nm)
U27A	270	275
U27B	275	280
U28	280	285

#### Notes:

1. Peak Wavelength measurement tolerance:  $\pm 1\text{nm}$ .
2. Forward voltage bins are defined at  $I_f=20\text{mA}$  operation.

### Forward Voltage Bins

Bin	Minimum Forward Voltage (V)	Maximum Forward Voltage (V)
5055	5.0	5.5
5560	5.5	6.0
6065	6.0	6.5
6570	6.5	7.0
7075	7.0	7.5

#### Notes:

1. Forward voltage measurement tolerance:  $\pm 2\%$ .
2. Forward voltage bins are defined at  $I_f=20\text{mA}$  operation.

### Mechanical Dimension

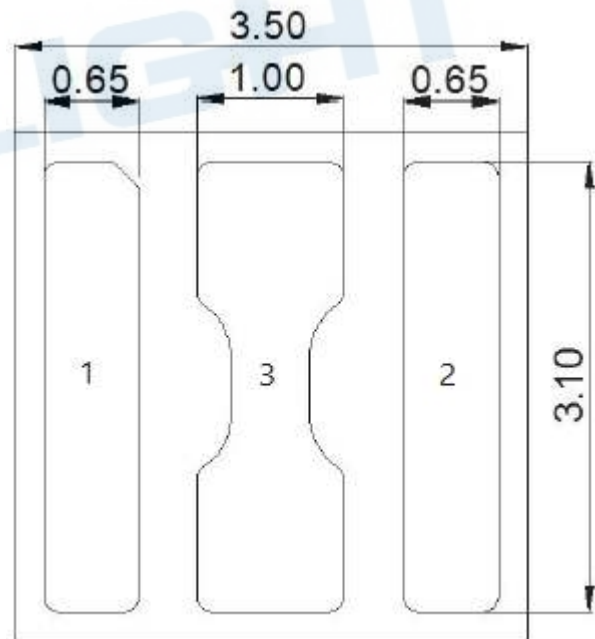
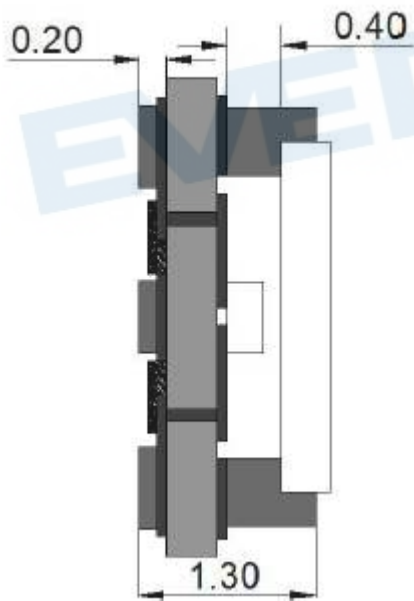
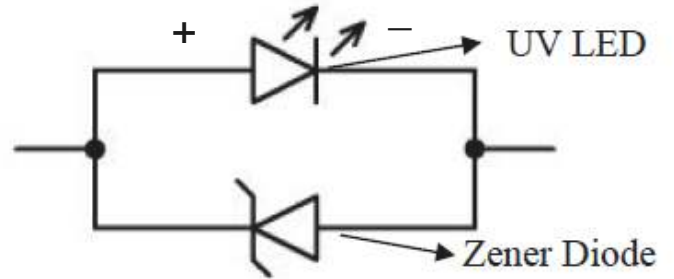
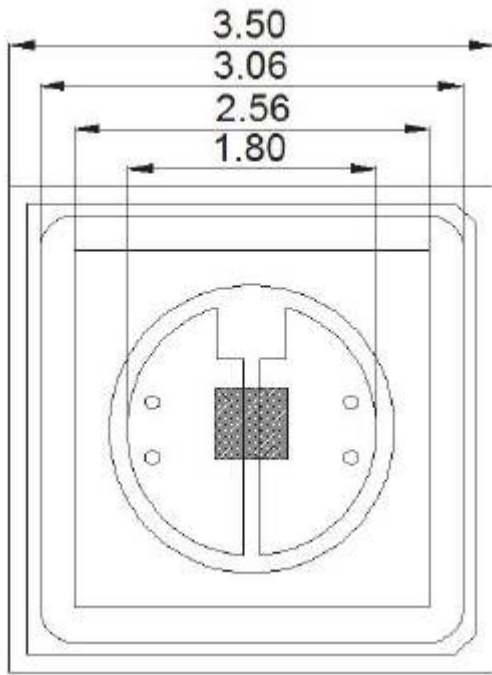

1. Dimensions are in millimeters.
2. Tolerances unless mentioned are  $\pm 0.2\text{mm}$
3. Pad Configuration 1:Cathode ,2:Anode ,3:Thermal Pad

## Reflow Soldering Characteristics

### For Reflow Process

- ELUC series are suitable for SMT processes.
- Curing of glue in oven must be according to standard operation flow processes.

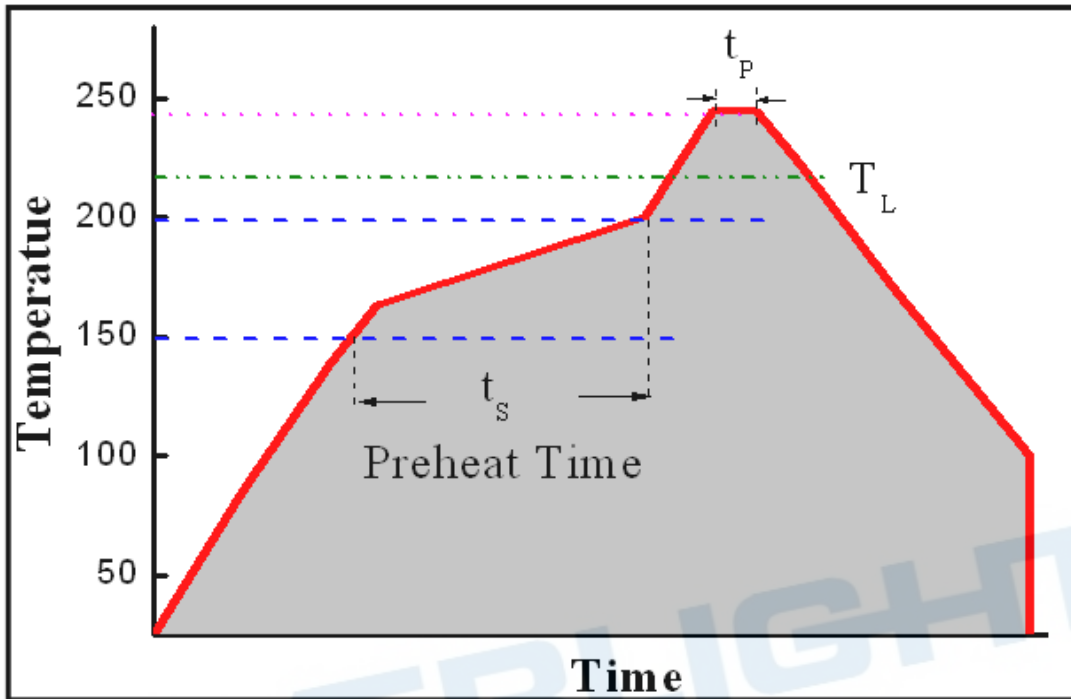

Profile Feature	Lead Free Assembly
Ramp-Up Rate	2-3 °C/S
Preheat Temperature	150-200 °C
Preheat Time ( $t_s$ )	60-120 S
Liquid Temperature ( $T_L$ )	217 °C
Time maintained above $T_L$	60-90 S
Peak Temperature ( $T_p$ )	240±5 °C
Peak Time ( $t_p$ )	Max 20 S
Ramp-Down Rate	3-5 °C/S

- Reflow soldering should not be done more than twice.
- In soldering process, stress on the LEDs during heating should be avoided.
- After soldering, do not bend the circuit board.

### Typical Characteristics Curves

Spectrum @ Thermal Pad Temperature = 25°C

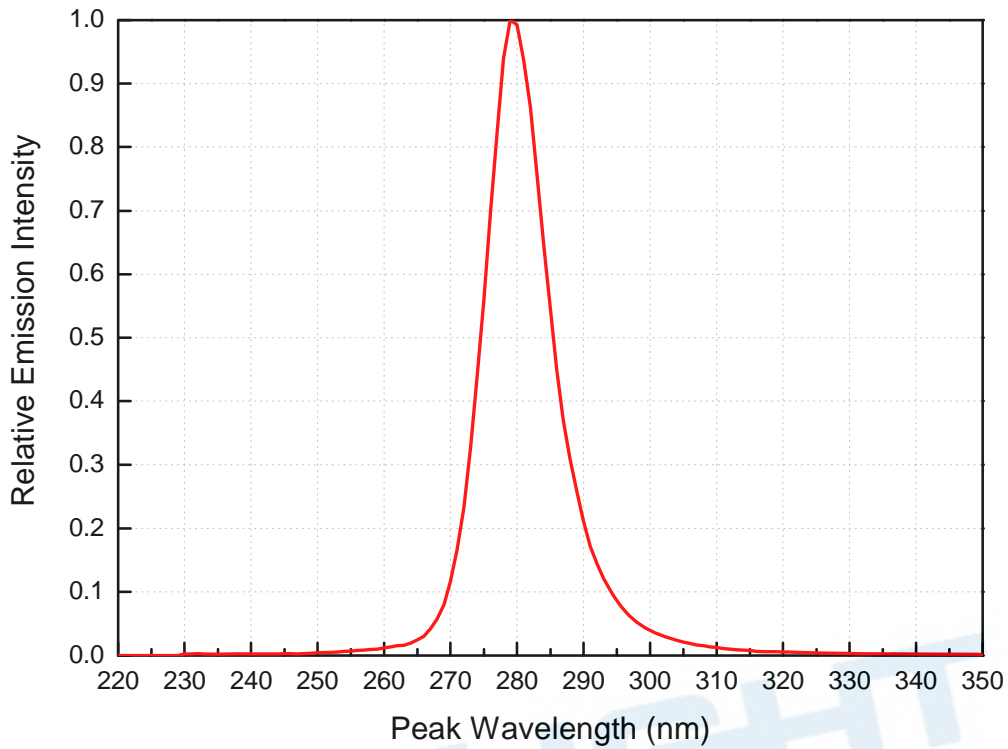

Typical Relative mW Flux vs. Forward Current  
@ Soldering Pad Temperature = 25°C

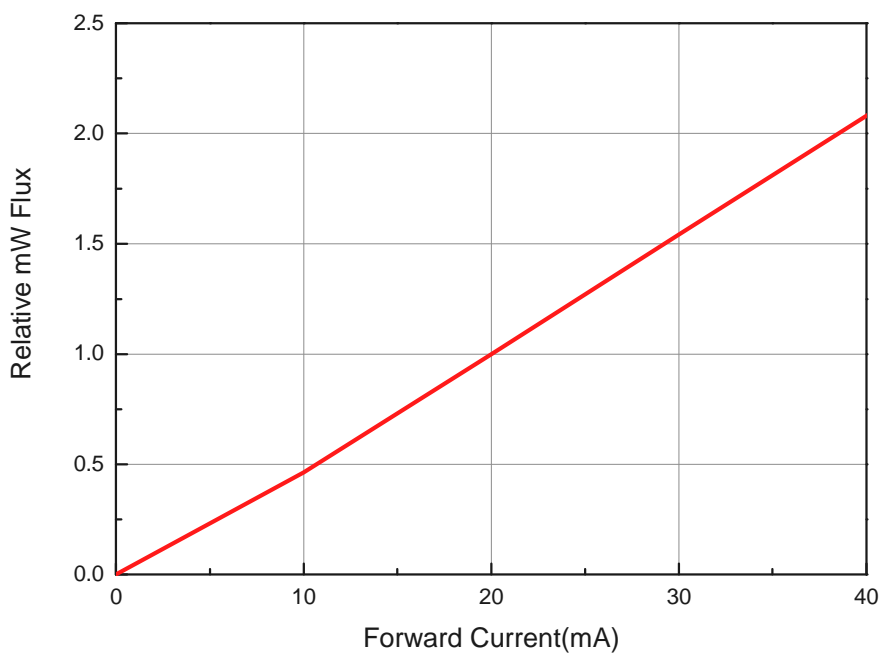

**Peak Wavelength vs. Current**  
**@ Soldering Pad Temperature = 25°C**

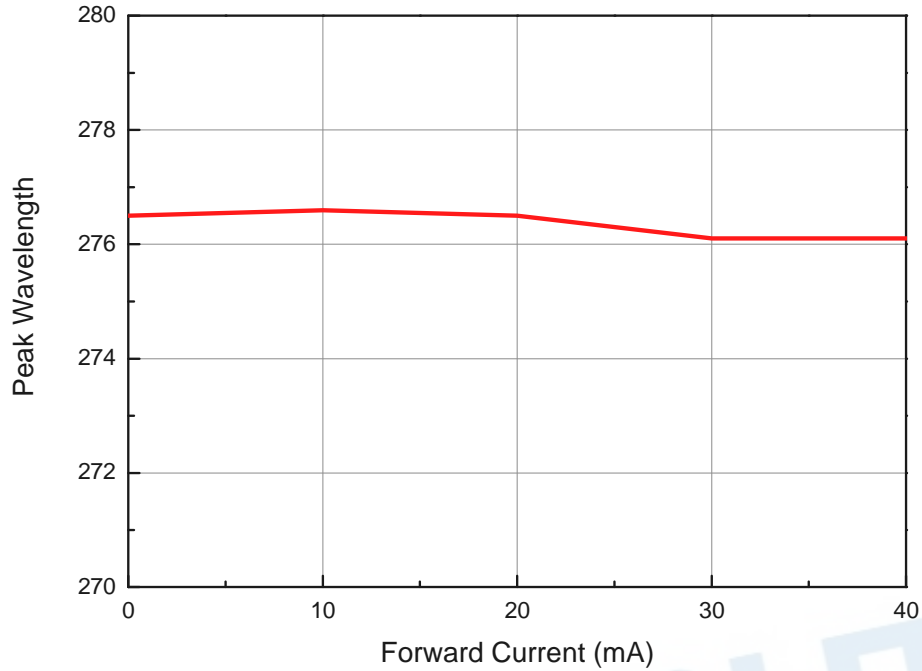

**Forward Current vs. Forward Voltage**  
**@ Soldering Pad Temperature = 25°C**

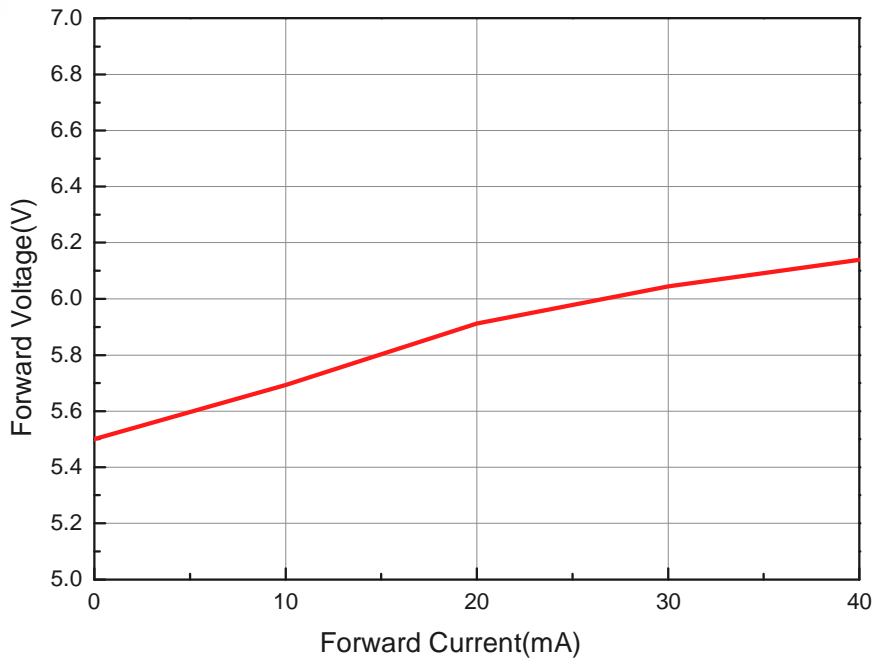



Derating Curve

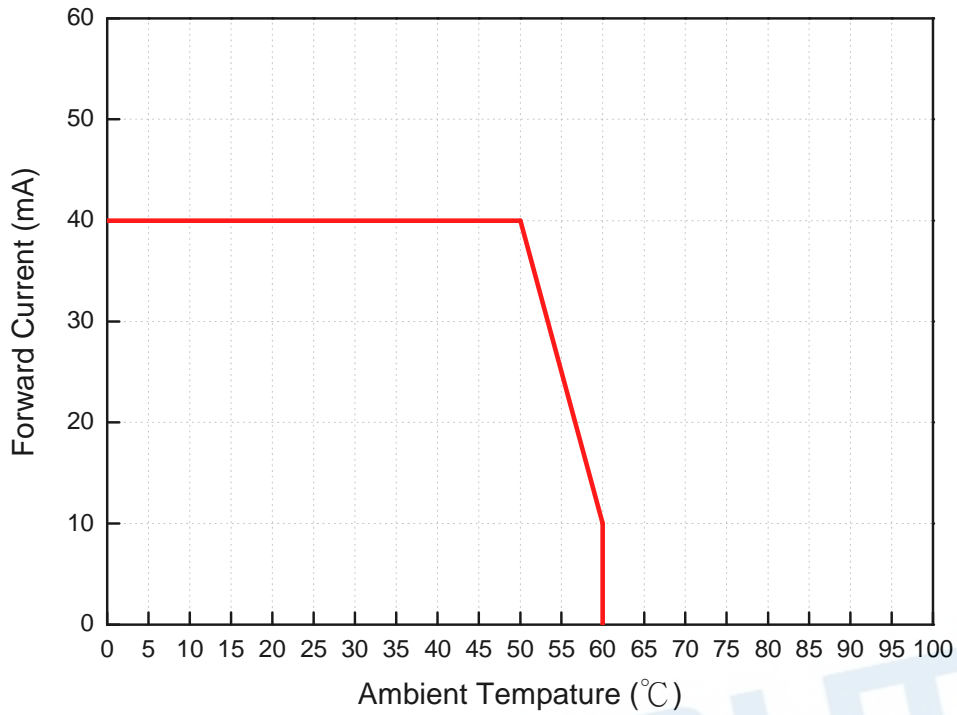

Typical Radiation Patterns  
 Typical Diagram Characteristics of Radiation for ELUC3535NUB

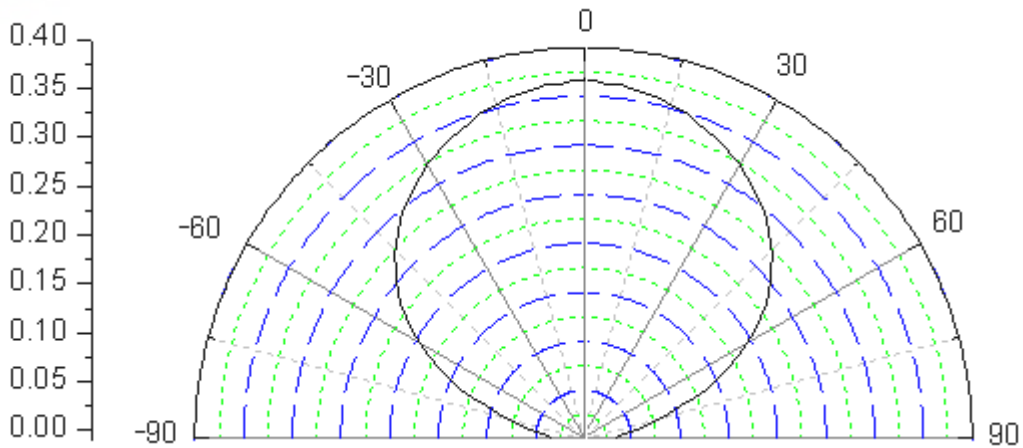

Notes:

1.  $2\theta_{1/2}$  is the off axis angle from lamp centerline where the luminous intensity is 1/2 of the peak value.
2. View angle tolerance is  $\pm 5^\circ$ .

### Emitter Tape Packaging

Carrier Tape Dimensions as the following:

Reel: 1000 pcs

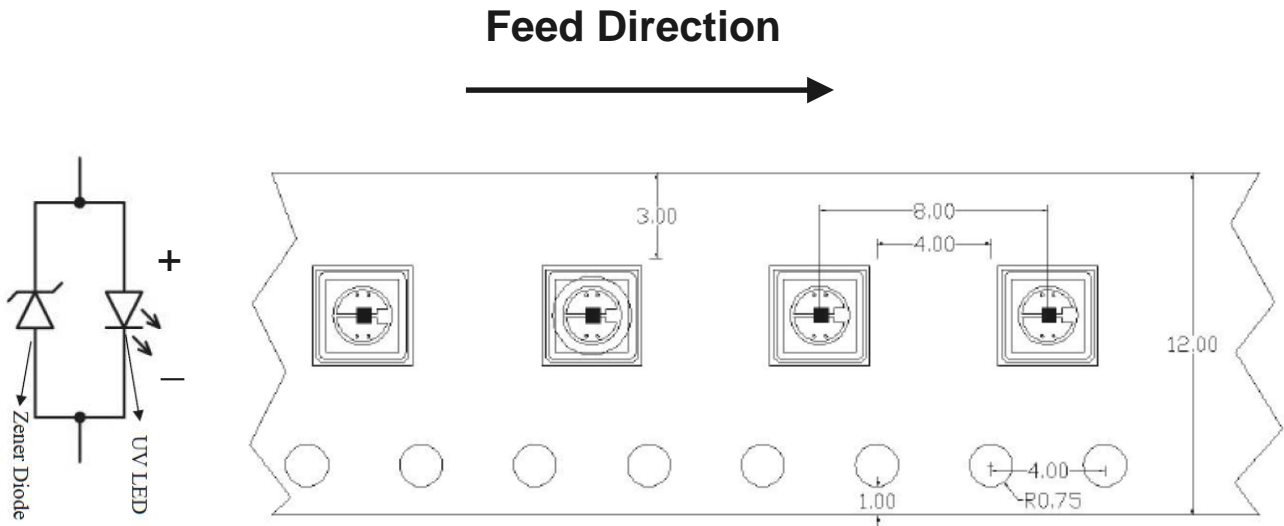

#### Notes:

1. Tolerance unless mentioned is  $\pm 0.2\text{mm}$ ;
2. Minimum packing amount is 1000 pcs per reel

### Moisture Resistant Packaging

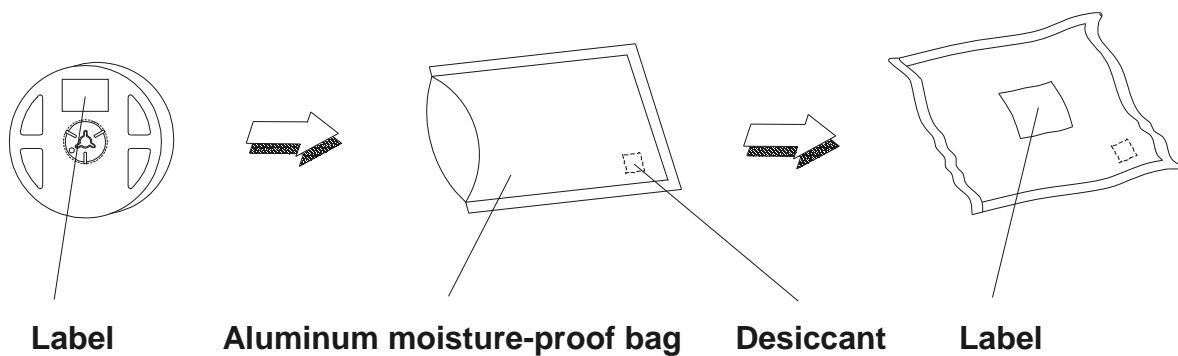

Emitter Reel Dimensions

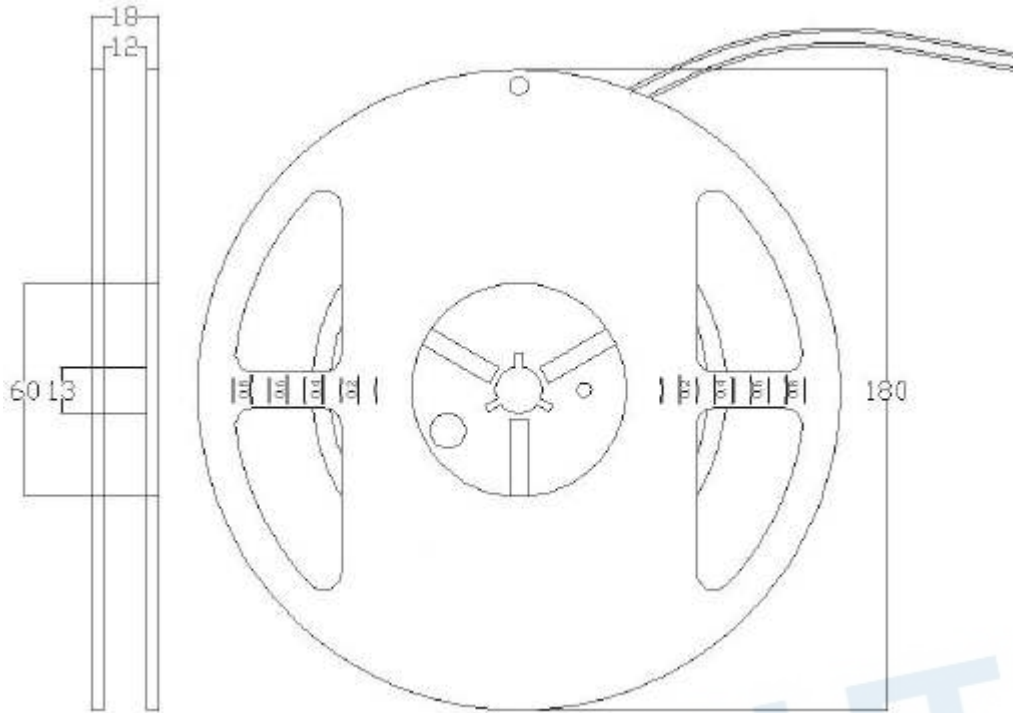

Notes:

1. Dimensions are in millimeters.
2. Tolerances unless mentioned are  $\pm 0.2\text{mm}$ .

Product Labeling

Label Explanation

- CPN: Customer Specification (when required)
- P/N : Everlight Production Number
- QTY: Packing Quantity
- CAT: Luminous Flux (Brightness) Bin
- HUE: Color Bin
- REF: Forward Voltage Bin
- LOT No: Lot Number
- MADE IN TAIWAN: Production Place

RoHS		EVERLIGHT	5
CPN: XXXXXXXXXXXXXXXXXXXX			
XXXXXXXXXX-XXXXXXXXXX-XXXXXXXXXX-XXXXXXXXXX-XXXXXX			
P/N: XXXXXXXXXXXX			
XXXXXXXXXX-XXXXXXXXXX-XXXXXXXXXX-XXXXXXXXXX-XXXXXX			
LOT NO: Y150716XXX-XXXXXXXXXX-XXXXXXXXXX			
QTY: 0123456789 HUE: XXXXXXXXXXXX			
CAT: XXXXXXXXXXXX REF: XXXXXXXXXXXX			
REFERENCE: BTPYYMDDXXXXX			
MSL-X		MADE IN XXXXXX	



## Storage Conditions

- Before the package is opened: The LEDs should be stored at 30°C or less and 85%RH or less after being shipped from Everlight and the storage life limits are 1 year. The LEDs can be stored up to 3 years if in a sealed container with a nitrogen atmosphere and moisture absorbent material.
- After opening the package: The LED's floor life is 168H under 30°C or less and 60% RH or less. If unused LEDs remain, it should be stored in moisture proof packages.
- If the moisture absorbent material (silica gel) has faded away or the LEDs have exceeded the storage time, baking treatment should be performed using the following conditions. Baking treatment: 60±5°C for 24 hours.

## DISCLAIMER

- EVERLIGHT reserves the right(s) on the adjustment of product material mix for the specification.
- The product meets EVERLIGHT published specification for a period of twelve (12) months from date of shipment.
- The graphs shown in this datasheet are representing typical data only and do not show guaranteed values.
- When using this product, please observe the absolute maximum ratings and the instructions for using outlined in these specification sheets. EVERLIGHT assumes no responsibility for any damage resulting from the use of the product which does not comply with the absolute maximum ratings and the instructions included in these specification sheets.
- These specification sheets include materials protected under copyright of EVERLIGHT. Reproduction in any form is prohibited without obtaining EVERLIGHT's prior consent.
- This product is not intended to be used for military, aircraft, automotive, medical, life sustaining or life saving applications or any other application which can result in human injury or death. Please contact authorized EVERLIGHT sales agent for special application request.