

# Hyper SIDELED® High-optical Power LED (HOP)

## LP A675



### Vorläufige Daten / Preliminary Data

#### Besondere Merkmale

- **Gehäusotyp:** weißes SMT-Gehäuse
- **Besonderheit des Bauteils:** Abstrahlung parallel zur Platine, deshalb ideal zur Einkopplung in Lichtleiter
- **Wellenlänge:** 560 nm (pure green)
- **Abstrahlwinkel:** Lambertischer Strahler (120°)
- **Technologie:** InGaAlP
- **optischer Wirkungsgrad:** 2 lm/W
- **Gruppierungsparameter:** Lichtstärke, Wellenlänge
- **Verarbeitungsmethode:** für alle SMT-Bestücktechniken geeignet
- **Lötmethode:** IR Reflow Löten und Wellenlöten (TTW)
- **Vorbehandlung:** nach JEDEC Level 2
- **Gurtung:** 12-mm Gurt mit 2000/Rolle, ø330 mm

#### Anwendungen

- Informationsanzeigen im Innen- und Außenbereich
- optischer Indikator
- Hinterleuchtung (LCD, Schalter, Tasten, Displays, Werbebeleuchtung, Allgemeinbeleuchtung)
- Innenbeleuchtung im Automobilbereich (z. B. Instrumentenbeleuchtung)
- Markierungsbeleuchtung (z.B. Stufen, Fluchtwege, u.ä.)
- Einkopplung in Lichtleiter
- Laufschriftanzeigen
- Signal- und Symbolleuchten

#### Features

- **package:** white SMT package
- **feature of the device:** radiation direction parallel to PCB, so an ideal LED for coupling into light guides
- **wavelength:** 560 nm (pure green)
- **viewing angle:** Lambertian Emitter (120°)
- **technology:** InGaAlP
- **optical efficiency:** 2 lm/W
- **grouping parameter:** luminous intensity, wavelength
- **assembly methods:** suitable for all SMT assembly methods
- **soldering methods:** IR reflow soldering and TTW soldering
- **preconditioning:** acc. to JEDEC Level 2
- **taping:** 12-mm tape with 2000/reel, ø330 mm

#### Applications

- indoor and outdoor displays
- optical indicators
- backlighting (LCD, switches, keys, displays, illuminated advertising, general lighting)
- interior automotive lighting (e.g. dashboard backlighting)
- marker lights (e.g. steps, exit ways, etc.)
- coupling into light guides
- light writing displays
- signal and symbol luminaire

Typ	Emissions- farbe	Farbe der Lichtaustritts- fläche	Lichtstärke	Lichtstrom	Bestellnummer
Type	Color of Emission	Color of the Light Emitting Area	Luminous Intensity $I_F = 30 \text{ mA}$ $I_V \text{ (mcd)}$	Luminous Flux $I_F = 30 \text{ mA}$ $\Phi_V \text{ (mlm)}$	Ordering Code
LP A675-N1P2-25	pure green	colorless clear	28.0 ... 71.0	150 (typ.)	Q62703Q6398

Anm.: -25 gesamter Farbbereich, Lieferung in Einzelgruppen (siehe **Seite 5**)

*Die Standardlieferform von Serientypen beinhaltet eine Familiengruppe, die aus 4 Halbgruppen besteht. Einzelne Halbgruppen sind nicht erhältlich.*

*In einer Verpackungseinheit / Gurt ist immer nur eine Halbgruppe enthalten.*

*Dimmverhältnis im Gleichstrom-Betrieb max. 5:1*

Note: -25 Total color tolerance range, delivery in single groups (see **page 5**)

*The standard shipping format for serial types includes a family group of 4 individual groups. Individual half groups are not available.*

*No packing unit / tape ever contains more than one luminous intensity half group.*

*Dimming range for direct current mode max. 5:1*

**Grenzwerte**  
**Maximum Ratings**

Bezeichnung Parameter	Symbol Symbol	Wert Value	Einheit Unit
Betriebstemperatur Operating temperature range	$T_{op}$	- 40 ... + 100	°C
Lagertemperatur Storage temperature range	$T_{stg}$	- 40 ... + 100	°C
Sperrschichttemperatur Junction temperature	$T_j$	+ 125	°C
Durchlassstrom Forward current	$I_F$	40	mA
Stoßstrom Surge current $t \leq 10 \mu s, D = 0.005$	$I_{FM}$	0.5	A
Sperrspannung <sup>1)</sup> Reverse voltage	$V_R$	12	V
Leistungsaufnahme Power consumption	$P_{tot}$	110	mW
Wärmewiderstand Thermal resistance Sperrschicht/Umgebung Junction/ambient	$R_{th JA}$	430	K/W
Sperrschicht/Löt看垫 Junction/soldering point Montage auf PC-Board FR 4 (Padgröße $\geq 16 \text{ mm}^2$ ) mounted on PC board FR 4 (pad size $\geq 16 \text{ mm}^2$ )	$R_{th JS}$	200	K/W

<sup>1)</sup> für kurzzeitigen Betrieb geeignet / suitable for short term application

Kennwerte ( $T_A = 25\text{ °C}$ )

## Characteristics

Bezeichnung Parameter		Symbol Symbol	Wert Value	Einheit Unit
Wellenlänge des emittierten Lichtes Wavelength at peak emission $I_F = 30\text{ mA}$	(typ.)	$\lambda_{\text{peak}}$	562	nm
Dominantwellenlänge <sup>1)</sup> Dominant wavelength <sup>1)</sup> $I_F = 30\text{ mA}$	(typ.)	$\lambda_{\text{dom}}$	560 $\pm 6$	nm
Spektrale Bandbreite bei 50 % $I_{\text{rel max}}$ Spectral bandwidth at 50 % $I_{\text{rel max}}$ $I_F = 30\text{ mA}$	(typ.)	$\Delta\lambda$	19	nm
Abstrahlwinkel bei 50 % $I_V$ (Vollwinkel) Viewing angle at 50 % $I_V$	(typ.)	$2\phi$	120	Grad deg.
Durchlassspannung <sup>2)</sup> Forward voltage <sup>2)</sup> $I_F = 30\text{ mA}$	(min.) (typ.) (max.)	$V_F$ $V_F$ $V_F$	1.8 2.0 2.4	V V V
Sperrstrom Reverse current $V_R = 12\text{ V}$	(typ.) (max.)	$I_R$ $I_R$	0.01 10	$\mu\text{A}$ $\mu\text{A}$
Temperaturkoeffizient von $\lambda_{\text{peak}}$ Temperature coefficient of $\lambda_{\text{peak}}$ $I_F = 30\text{ mA}; -10\text{ °C} \leq T \leq 100\text{ °C}$	(typ.)	$TC_{\lambda_{\text{peak}}}$	0.11	nm/K
Temperaturkoeffizient von $\lambda_{\text{dom}}$ Temperature coefficient of $\lambda_{\text{dom}}$ $I_F = 30\text{ mA}; -10\text{ °C} \leq T \leq 100\text{ °C}$	(typ.)	$TC_{\lambda_{\text{dom}}}$	0.10	nm/K
Temperaturkoeffizient von $V_F$ Temperature coefficient of $V_F$ $I_F = 30\text{ mA}; -10\text{ °C} \leq T \leq 100\text{ °C}$	(typ.)	$TC_V$	- 2.0	mV/K
Optischer Wirkungsgrad Optical efficiency $I_F = 30\text{ mA}$	(typ.)	$\eta_{\text{opt}}$	2	lm/W

<sup>1)</sup> Wellenlängen werden mit einer Stromeinprägedauer von 25 ms und einer Genauigkeit von  $\pm 1\text{ nm}$  ermittelt.  
Wavelengths are tested at a current pulse duration of 25 ms and a tolerance of  $\pm 1\text{ nm}$ .

<sup>2)</sup> Spannungswerte werden mit einer Stromeinprägedauer von 1 ms und einer Genauigkeit von  $\pm 0,1\text{ V}$  ermittelt.  
Voltages are tested at a current pulse duration of 1 ms and a tolerance of  $\pm 0.1\text{ V}$ .

<sup>1)</sup> Wellenlängengruppen  
Wavelength groups

Gruppe Group	pure green		Einheit Unit
	min.	max.	
2	554	557	nm
3	557	560	nm
4	560	563	nm
5	563	566	nm

Helligkeits-Gruppierungsschema  
Luminous Intensity Groups

Lichtgruppe Luminous Intensity Group	Lichtstärke Luminous Intensity $I_V$ (mcd)	Lichtstrom Luminous Flux $\Phi_V$ (lm)
N1	28.0 ... 35.5	95.0 (typ.)
N2	35.5 ... 45.0	120.0 (typ.)
P1	45.0 ... 56.0	150.0 (typ.)
P2	56.0 ... 71.0	190.0 (typ.)

Helligkeitswerte werden mit einer Stromeinprägedauer von 25 ms und einer Genauigkeit von  $\pm 11\%$  ermittelt.  
Luminous intensity is tested at a current pulse duration of 25 ms and a tolerance of  $\pm 11\%$ .

Gruppenbezeichnung auf Etikett  
Group Name on Label

Beispiel: N2  
Example: N2

Lichtgruppe Luminous Intensity Group	Halbgruppe Half Group
N	2

Relative spektrale Emission  $I_{rel} = f(\lambda)$ ,  $T_A = 25\text{ °C}$ ,  $I_F = 30\text{ mA}$

Relative Spectral Emission

$V(\lambda)$  = spektrale Augenempfindlichkeit

Standard eye response curve

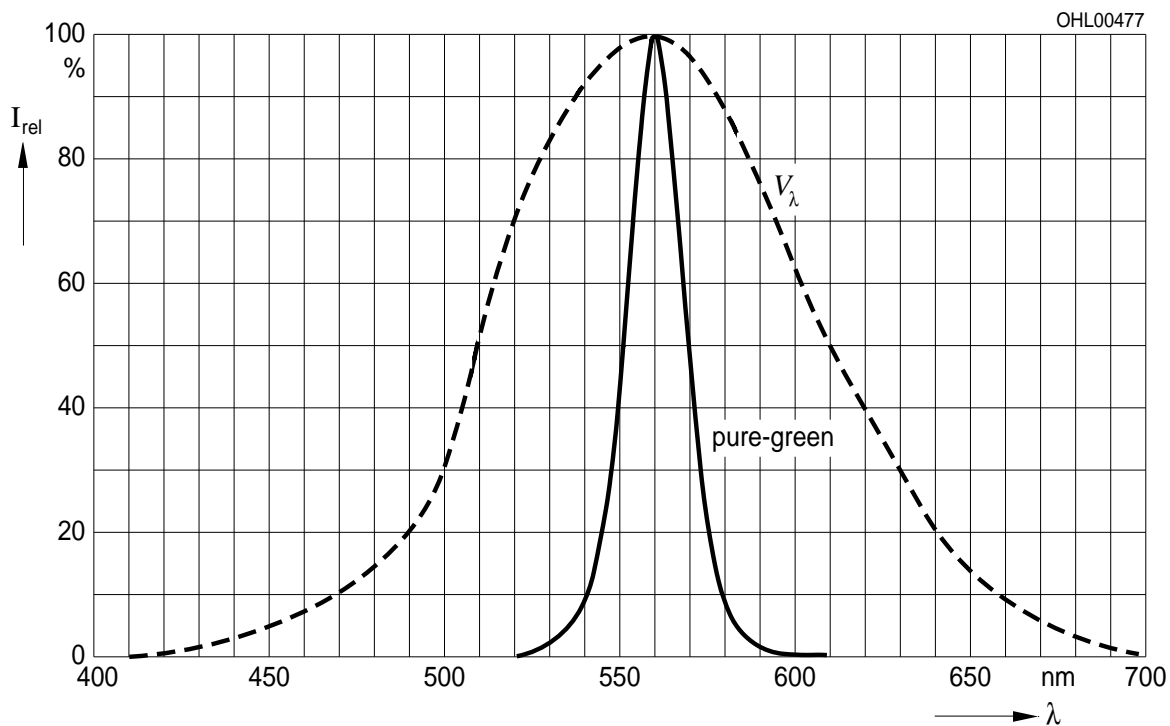

Abstrahlcharakteristik  $I_{rel} = f(\varphi)$

Radiation Characteristic

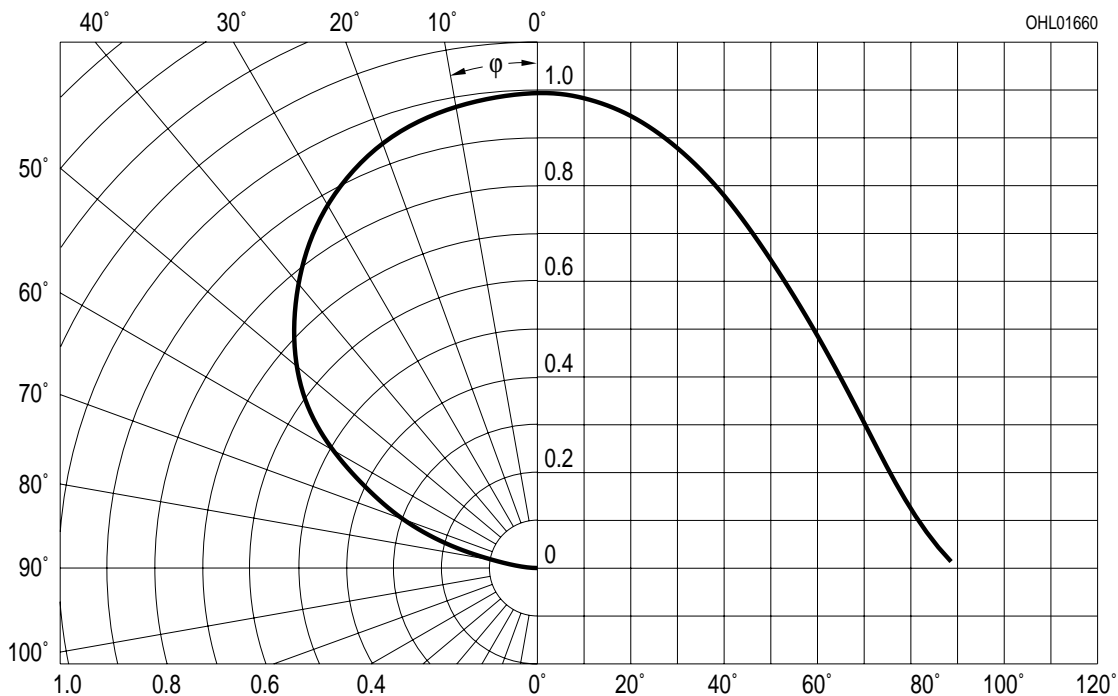

**Durchlassstrom  $I_F = f(V_F)$**

**Forward Current**

$T_A = 25\text{ °C}$

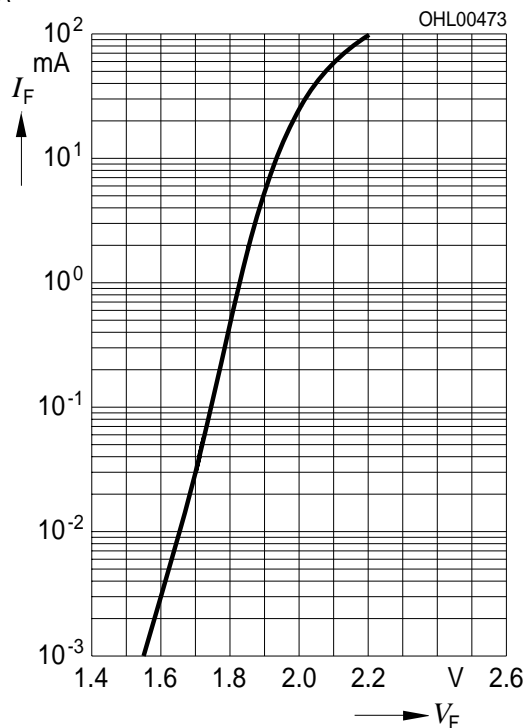

**Relative Lichtstärke  $I_V / I_{V(30\text{ mA})} = f(I_F)$**

**Relative Luminous Intensity**

$T_A = 25\text{ °C}$

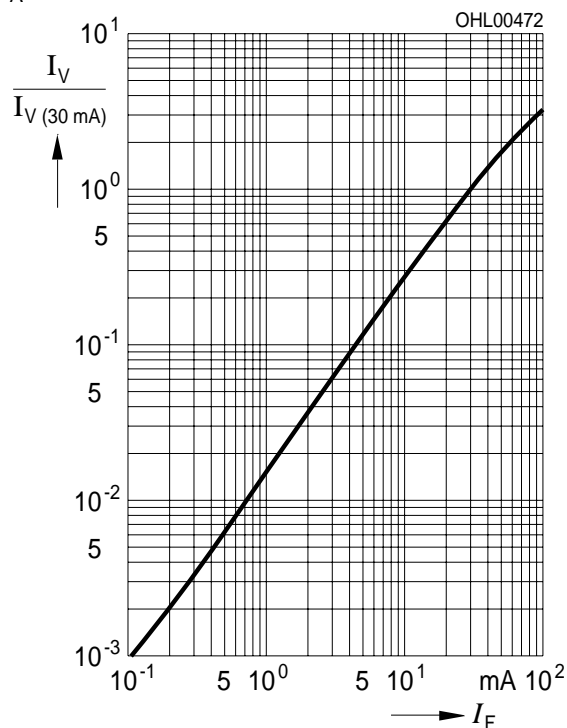

**Maximal zulässiger Durchlassstrom  $I_F = f(T_A)$**

**Max. Permissible Forward Current**

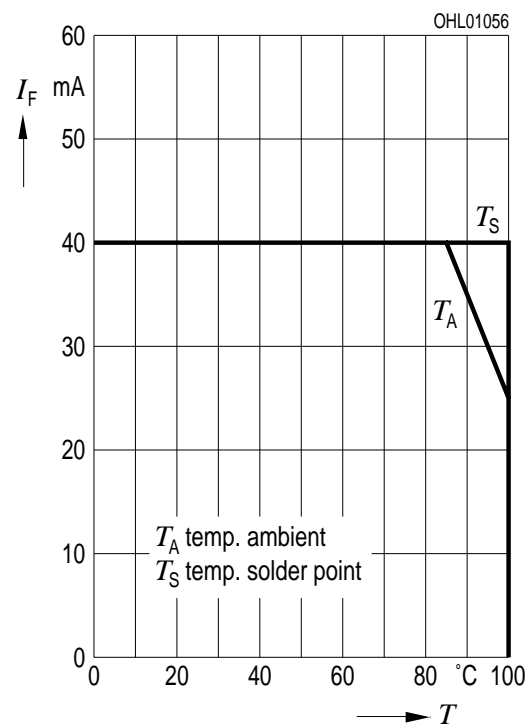

**Relative Lichtstärke  $I_V / I_{V(25\text{ °C})} = f(T_A)$**

**Relative Luminous Intensity**

$I_F = 30\text{ mA}$

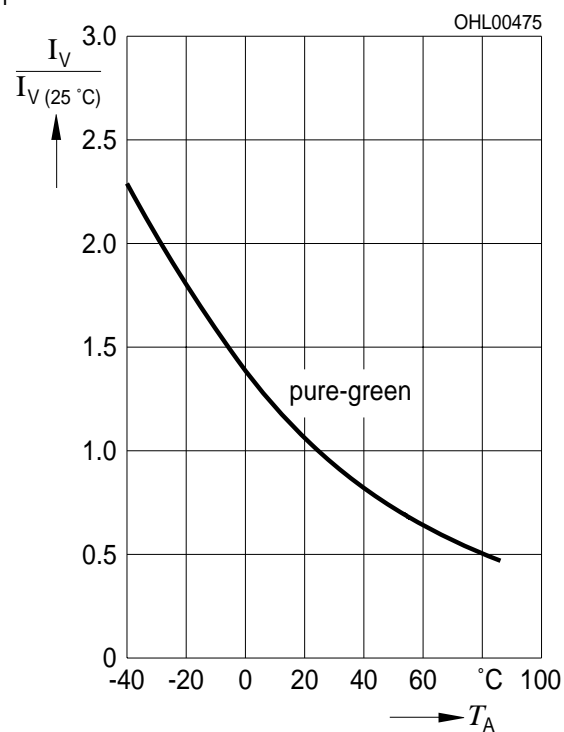

**Zulässige Impulsbelastbarkeit  $I_F = f(t_p)$**   
**Permissible Pulse Handling Capability**

Duty cycle  $D =$  parameter,  $T_A = 25\text{ °C}$

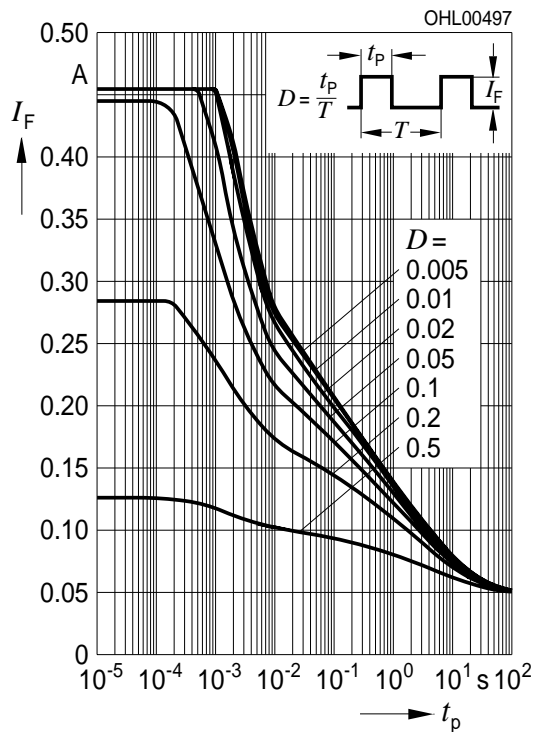

**Zulässige Impulsbelastbarkeit  $I_F = f(t_p)$**   
**Permissible Pulse Handling Capability**

Duty cycle  $D =$  parameter,  $T_A = 85\text{ °C}$

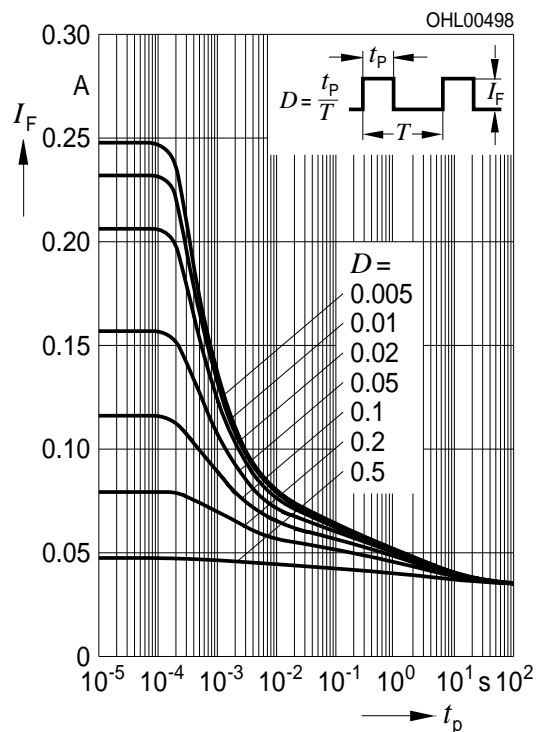



**Maßzeichnung  
Package Outlines**

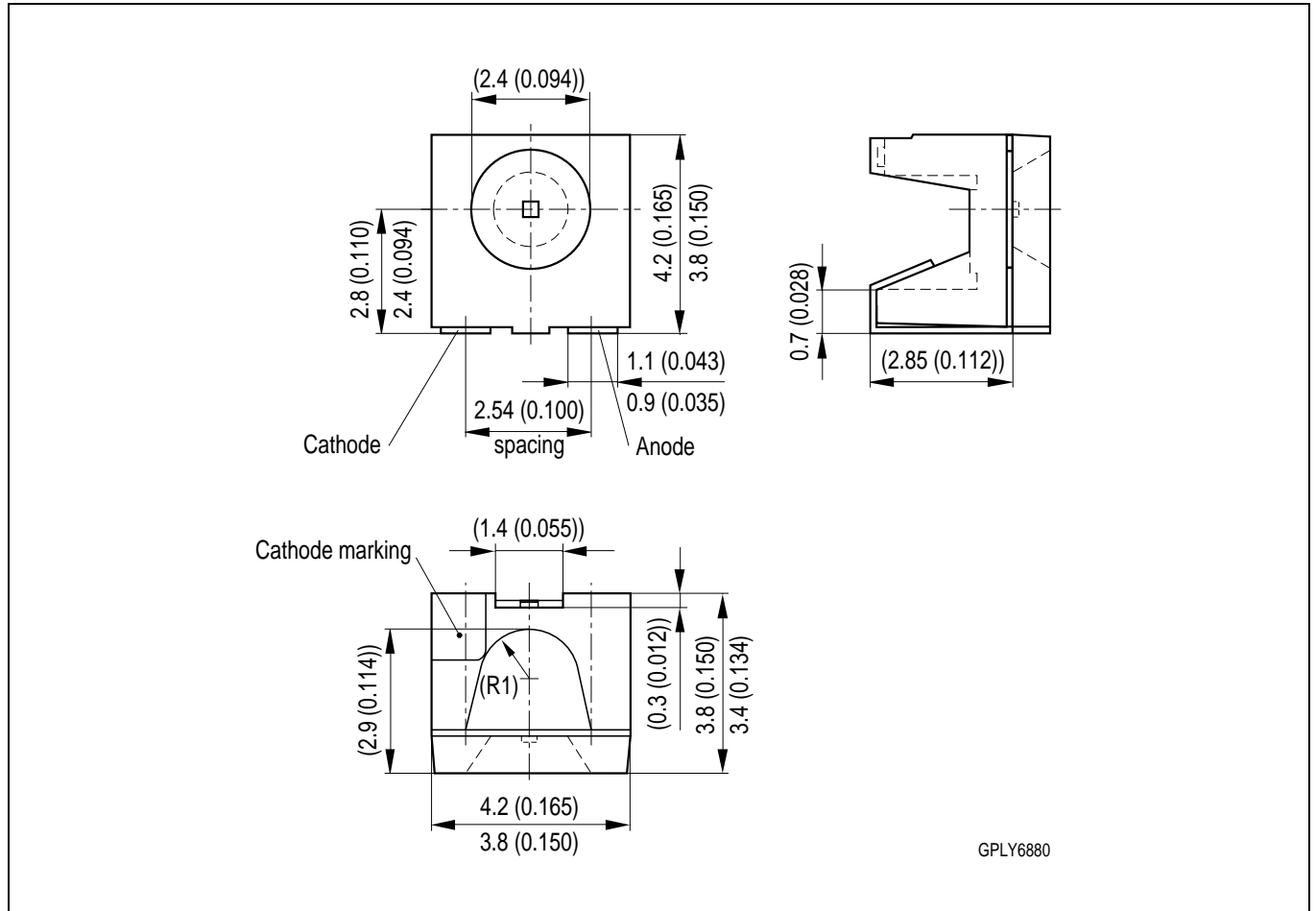

Maße werden wie folgt angegeben: mm (inch) / Dimensions are specified as follows: mm (inch).

**Kathodenkennung:** abgeschrägte Ecke  
**Cathode mark:** bevelled edge  
**Gewicht / Approx. weight:** 40 mg

**Lötbedingungen** Vorbehandlung nach JEDEC Level 2  
**Soldering Conditions** Preconditioning acc. to JEDEC Level 2

**IR-Reflow Lötprofil** (nach IPC 9501)  
**IR Reflow Soldering Profile** (acc. to IPC 9501)

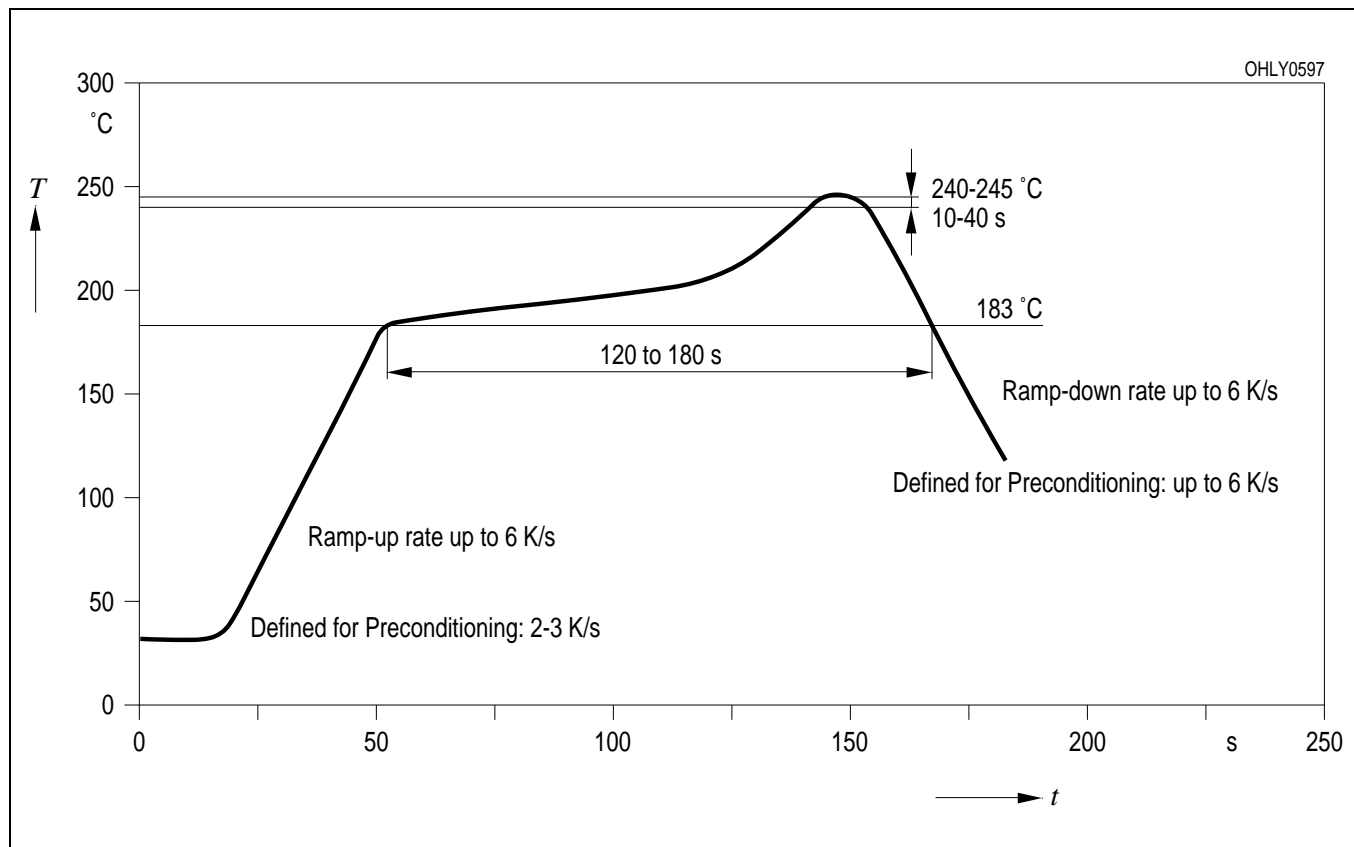

**Wellenlöten (TTW)** (nach CECC 00802)  
**TTW Soldering** (acc. to CECC 00802)

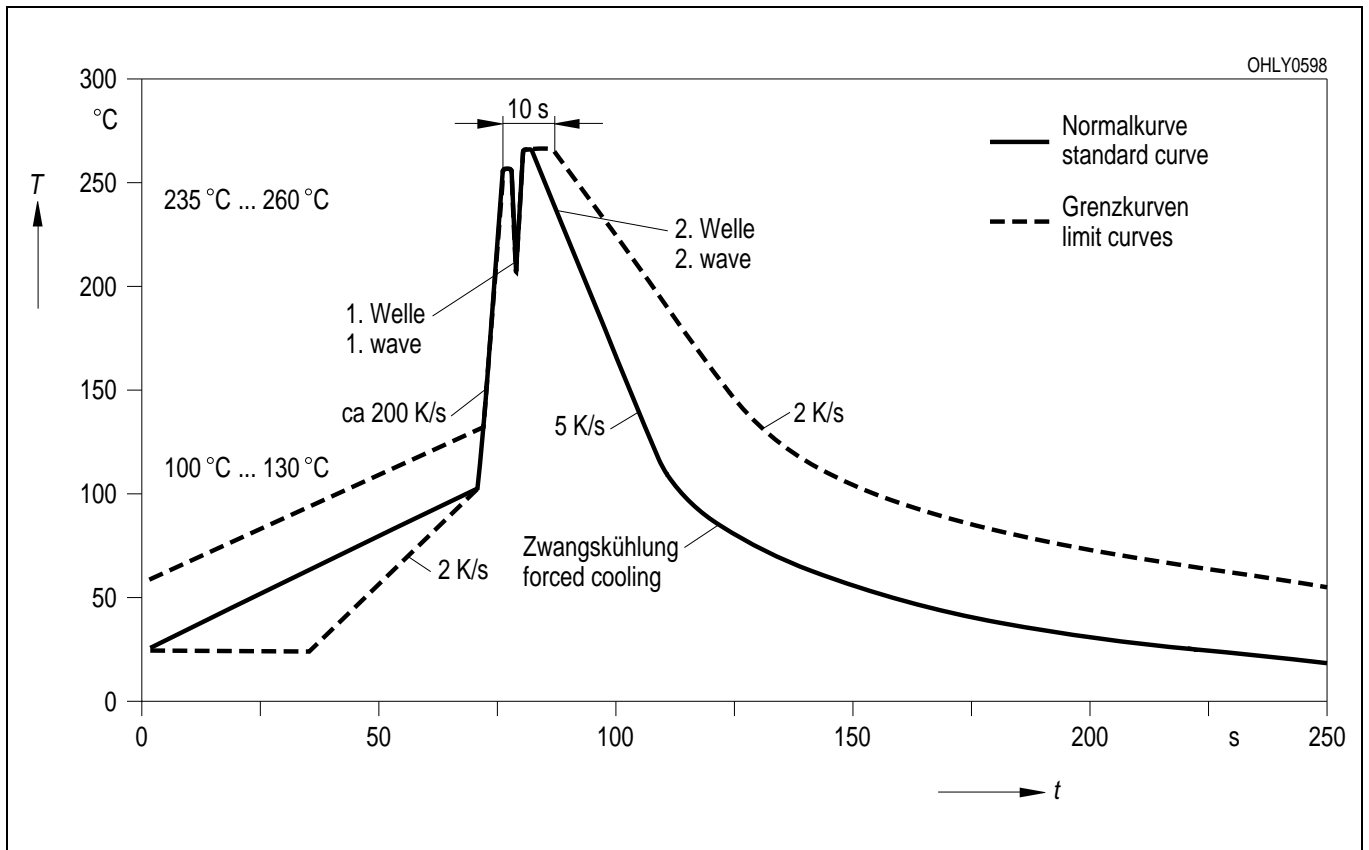

**Empfohlenes Lötpad Design** Wellenlöten (TTW)  
**Recommended Solder Pad** TTW Soldering

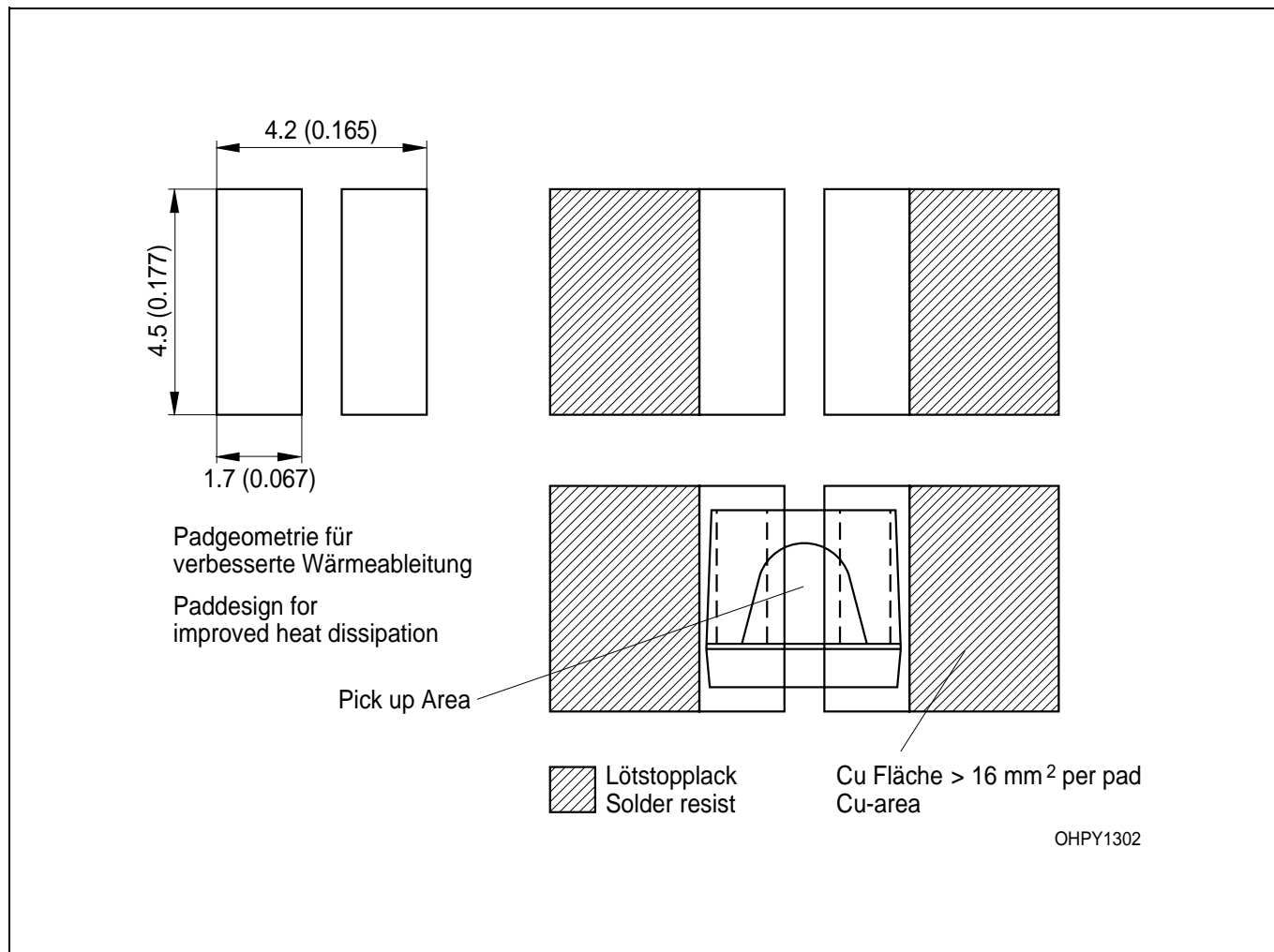

Maße werden wie folgt angegeben: mm (inch) / Dimensions are specified as follows: mm (inch).

**Empfohlenes Lötpad Design** IR Reflow Lötten  
**Recommended Solder Pad** IR Reflow Soldering

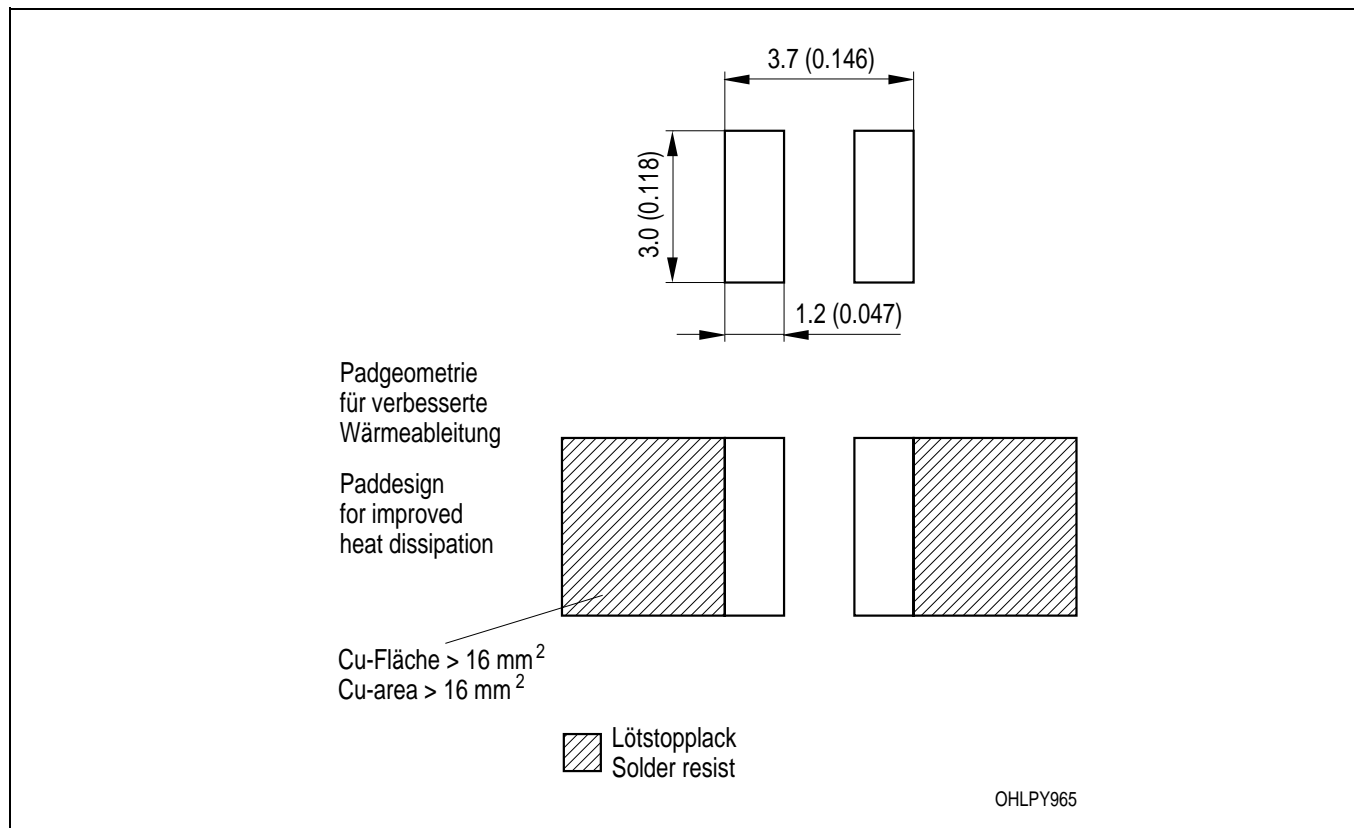

Maße werden wie folgt angegeben: mm (inch) / Dimensions are specified as follows: mm (inch).

**Gurtung / Polarität und Lage** Verpackungseinheit 2000/Rolle, ø330 mm  
**Method of Taping / Polarity and Orientation** Packing unit 2000/reel, ø330 mm

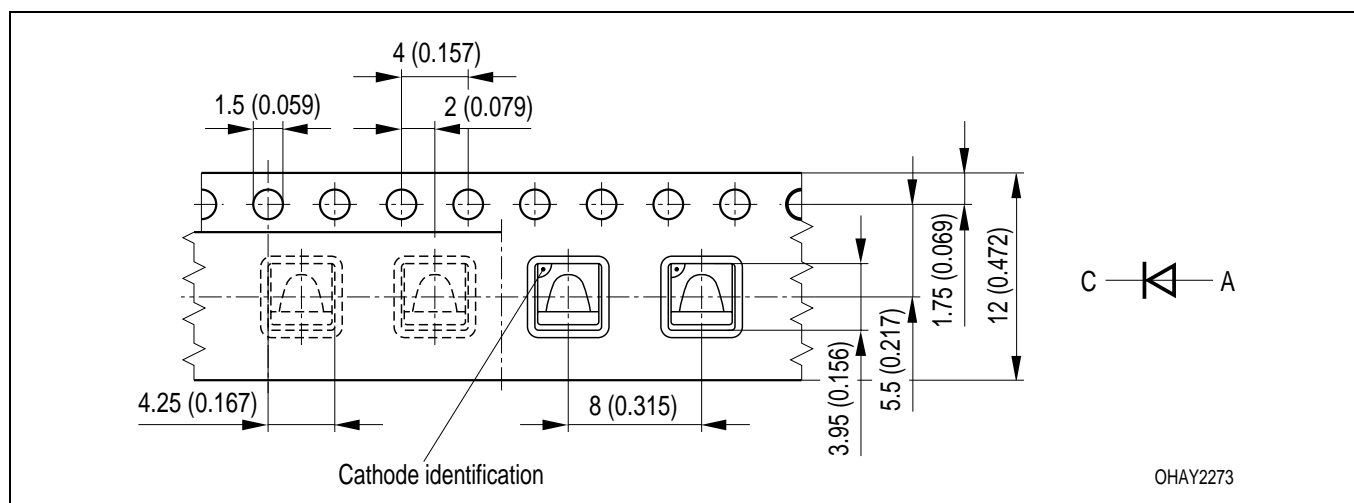

Maße werden wie folgt angegeben: mm (inch) / Dimensions are specified as follows: mm (inch).

Revision History: 2003-01-20		Date of change
Previous Version: 2002-10-08		
Page	Subjects (major changes since last revision)	
7	change of diagram from OHL00837 to OHL01056	2003-01-20

Published by OSRAM Opto Semiconductors GmbH  
Wernerwerkstrasse 2, D-93049 Regensburg

© All Rights Reserved.

**Attention please!**

The information describes the type of component and shall not be considered as assured characteristics.

All typical data and graphs are basing on representative samples, but don't represent the production range. If requested, e.g. because of technical improvements, these typ. data will be changed without any further notice.

Terms of delivery and rights to change design reserved. Due to technical requirements components may contain dangerous substances. For information on the types in question please contact our Sales Organization.

If printed or downloaded, please find the latest version in the Internet.

**Packing**

Please use the recycling operators known to you. We can also help you – get in touch with your nearest sales office. By agreement we will take packing material back, if it is sorted. You must bear the costs of transport. For packing material that is returned to us unsorted or which we are not obliged to accept, we shall have to invoice you for any costs incurred.

**Components used in life-support devices or systems must be expressly authorized for such purpose!** Critical components <sup>1</sup> may only be used in life-support devices or systems <sup>2</sup> with the express written approval of OSRAM OS.

<sup>1</sup> A critical component is a component used in a life-support device or system whose failure can reasonably be expected to cause the failure of that life-support device or system, or to affect its safety or the effectiveness of that device or system.

<sup>2</sup> Life support devices or systems are intended (a) to be implanted in the human body, or (b) to support and/or maintain and sustain human life. If they fail, it is reasonable to assume that the health of the user may be endangered.