



EVL8030-QJ-00B

IEEE 802.3af/at/bt Compatible, PoE PD with PD Interface and Primary-Side Regulated Flyback Controller Evaluation Board

PRELIMINARY SPECIFICATIONS SUBJECT TO CHANGE

DESCRIPTION

The EVL8030-QJ-00B is an evaluation board designed to demonstrate the capabilities of the MP8030, a fully integrated, IEEE 802.3af/at/bt compatible, power over Ethernet (PoE) powered device (PD) with a PD interface and high-efficiency, primary-side regulated (PSR) flyback controller.

The PD interface has all IEEE 802.3af/at/bt functions. It also has a 100V integrated hot-swap MOSFET and a gate driver (GATE1) to improve efficiency for high-power applications. The second gate driver (GATE2) supports the external, low $R_{DS(ON)}$ N-channel MOSFET, which replaces the traditional diode O-ring to avoid power loss on the diode while powered by an adaptor.

The flyback controller is designed for both small-sized, isolated, PSR flyback applications, as well as high-efficiency, secondary-side regulated (SSR), active-clamped forward applications. The MP8030 can also be used for SSR flyback topologies.

The MP8030 is available in a QFN-32 (5mmx6mm) package.

ELECTRICAL SPECIFICATIONS

Parameter	Symbol	Value	Units
Input voltage	V_{IN}	41 to 57	V
Output voltage	V_{OUT}	12	V
Output current	I_{OUT}	6	A

FEATURES

- 41V to 57V Power over Ethernet (PoE) Input or 48V Auxiliary Adapter Input
- 12V Output Voltage and 6A Output Current
- Primary-Side Regulation (PSR) Flyback
- 802.3af/at/bt Compatible
- Integrated Detection Resistor
- GATE2 N-Channel MOSFET for Adapter
- Supports Automatic Classification
- Automatic Maintain Power Signature (MPS)
- Frequency Dithering for EMI Reduction
- Auxiliary Winding Supply (VCC) for Power Loss Reduction
- OLP, SCP, and OVP with Hiccup Mode
- Thermal Shutdown
- Available in a QFN-32 (5mmx6mm) Package

 **Optimized Performance with MPS Inductor**

APPLICATIONS

- IEEE 802.3af/at/bt Compatible Devices
- Security Cameras
- Video Phones
- WLAN Access Points
- Internet of Things (IoT)
- Pico Base Stations

All MPS parts are lead-free, halogen-free, and adhere to the RoHS directive. For MPS green status, please visit the MPS website under Quality Assurance. "MPS", the MPS logo, and "Simple, Easy Solutions" are trademarks of Monolithic Power Systems, Inc. or its subsidiaries.

EVL8030-QJ-00B EVALUATION BOARD



LxWxH (16.2cmx5cmx2cm)

Board Number	MPS IC Number	MPS Inductor
EVL8030-QJ-00B	MP8030GQJ	MPL-AL5050-100

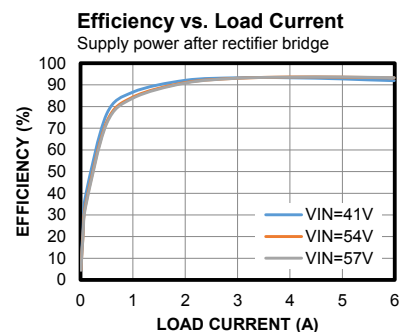

QUICK START GUIDE

The evaluation board's output voltage (V_{OUT}) is set at 12V. The board layout accommodates most commonly used components. There are two methods to start up the board, described below.

Start-Up Method 1

1. Connect the load terminals to:
 - a. Positive (+): VOUT
 - b. Negative (-): VOUT_GND
2. Plug the PSE cable into the ethernet jack (J1). The board should start up automatically.

Start-Up Method 2

1. Preset the power supply between 41V and 57V.
2. Turn off the power supply.
3. Connect the power supply terminals to:
 - a. Positive (+): VDD
 - b. Negative (-): VSS
4. Connect the load terminals to:
 - a. Positive (+): VOUT
 - b. Negative (-): VOUT_GND
5. After making the connections, turn on the power supply. The board should start up automatically.
6. The MP8030 is enabled on the evaluation board once V_{DD} is applied.
7. To use the adapter supply function, follow steps 7 and 8:
 - a. Positive (+): ADAPOT
 - b. Negative (-): ADAPOT_GND
8. After making the connections, turn on the adapter. The board should automatically be supplied via the adapter.

EVALUATION BOARD SCHEMATIC

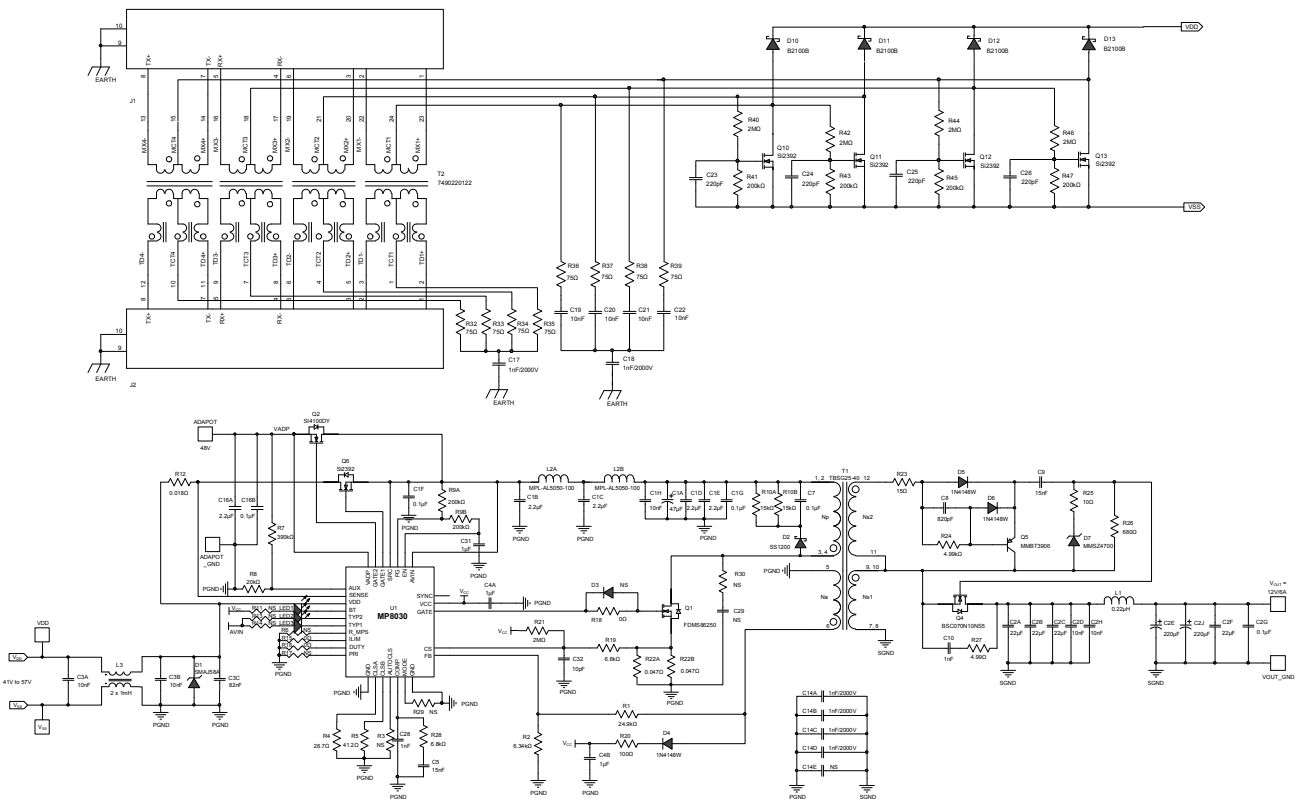

Figure 1: Evaluation Board Schematic (1) (2)

Note:

- 1) Resistor R19 enables frequency dithering. The frequency dithering function can also be disabled by setting R19 below 1kΩ. Choose R21 such that it maintains the original R21:R19 ratio (2MΩ:6.8kΩ).
- 2) To enable the LED indicator, set R11 to 9.09kΩ, R13 to 53.6kΩ, and R14 to 53.6kΩ. R11, R13, and R14 are not soldered to the evaluation board by default.

EVL8030-QJ-00B BILL OF MATERIALS

Qty	Ref	Value	Description	Package	Manufacturer	Manufacturer PN
2	L2A, L2B	10 μ H	Inductor, I _{RATED} = 4.8A, I _{SAT} = 5.5A, RDC = 37m Ω	5050	MPS	MPL-AL5050-100
1	C1A	47 μ F	Electrolytic capacitor, 100V	DIP	Jianghai	ECR2AXY470MLB100012
5	C1B, C1C, C1D, C1E, C16A	2.2 μ F	Ceramic capacitor, 100V, X7R	1210	Murata	GRM32ER72A225KA88L
4	C1F, C1G, C7, C16B	0.1 μ F	Ceramic capacitor, 100V, X7R	0805	Murata	GRM21BR72A104KAC4L
3	C1H, C3A, C3B	10nF	Ceramic capacitor, 100V, X7R	0603	Murata	GRM188R72A103KA01D
4	C2A, C2B, C2C, C2F	22 μ F	Ceramic capacitor, 25V, X7R	1210	Murata	GRM32ER71E226KE15L
2	C2D, C2H	10nF	Ceramic capacitor, 25V, X7R	0603	Murata	GRM188R71E103KA01D
2	C2E, C2J	220 μ F	Electrolytic capacitor, 25V	DIP	Jianghai	CD284
1	C2G	0.1 μ F	Ceramic capacitor, 25V, X7R	0603	Murata	GRM188R71E104KA01D
1	C3C	82nF	Ceramic capacitor, 100V, X7R	1206	Murata	GRM319R72A823KA01D
3	C4A, C4B, C31	1 μ F	Ceramic capacitor, 25V, X7R	0603	Murata	GRM188R71E105KA01D
1	C5	15nF	Ceramic capacitor, 16V, X7R	0603	Murata	GRM188R71C153KA01D
1	C8	820pF	Ceramic capacitor, 25V, X7R	0603	Murata	GRM188R71E821JA01D
1	C9	15nF	Ceramic capacitor, 25V, X7R	0603	Murata	GRM188R71E153KA01D
1	C10	1nF	Ceramic capacitor, 100V, X7R	0603	Murata	GRM188R72A102KA01D
6	C14A, C14B, C14C, C14D, C17, C18	1nF	Ceramic capacitor, 2000V, X7R	1808	Murata	GR442QR73D102KW01L
0	C14E, C29, D3, R3, R11, R13, R14, R17, R29, R30	NS				
4	C19, C20, C21, C22	10nF	Ceramic capacitor, 100V, X7R	0603	Murata	GRM188R72A103KA01D
4	C23, C24, C25, C26	220pF	Ceramic capacitor, 50V, X7R	0603	Murata	GRM188R71H221KA01D
1	C28	1nF	Ceramic capacitor, 16V, X7R	0603	Murata	GRM188R71C102KA01D
1	C32	10pF	Ceramic capacitor, 50V, X7R	0603	Murata	GRM188R71H100KA01D
1	D1	400W	TVS diode, 4.3A	SMA	Littelfuse, Inc.	SMAJ58A
1	D2	200V	Schottky diode, 1A	SMA	Micro Commercial	SS1200
3	D4, D5, D6	100V	Diode switch	SOD-123	Diodes, Inc.	1N4148W
1	D7	13V	Zener diode	SOD-123	General Semiconductor	MMSZ4700
4	D10, D11, D12, D13	100V	Schottky diode, 2A	SMB	Diodes, Inc.	B2100-13-F
2	J1, J2	1.5A	Jack connector, RJ45, 120V _{AC}	8P8C	Würth	615008140121

EVL8030-QJ-00B BILL OF MATERIALS (continued)

Qty	Ref	Value	Description	Package	Manufacturer	Manufacturer PN
1	L1	0.22µH	I _{RATED} = 9.5A, RDC = 6.5mΩ	4020	Sunlord	WPN4020HR22MT
		0.22µH	I _{RATED} = 9.5A, RDC = 6.6mΩ	4020	Würth	744373240022
1	L3	2 x 1mH	Common mode choke 2 x 1mH, 2.5A, 2 x 55mΩ	DIP	Würth	7448012501
3	LED1, LED2, LED3	2.2V	Green LED, 2.2V, 20mA	0603	Rohm Semiconductor	SML-D12M8WT86
1	Q1	25mΩ	N-channel MOSFET, 150V, 6.7A	Power 56	On Semiconductor	FDMS86250
1	Q2	63mΩ	N-channel MOSFET, 100V, 6.8A	SOIC-8	Vishay	Si4100DY-T1-GE3
1	Q4	7mΩ	N-channel MOSFET, 100V, 80A	PG-TDSON-8	Infineon	BSC070N10NS5
1	Q5	350mW	PNP general-purpose amplifier, 40V, 0.2A	SOT-23	Micro Commercial	MMBT3906
5	Q6, Q10, Q11, Q12, Q13	126mΩ	N-channel MOSFET, 100V, 3.1A	SOT-23	Vishay	Si2392DS-T1-GE3
1	R1	24.9kΩ	Film resolution, 1%	0603	Yageo	RL0603FR-0724K9L
1	R2	6.34kΩ	Film resolution, 1%	0603	Yageo	RL0603FR-076K34L
1	R4	28.7Ω	Film resolution, 1%	0603	Yageo	RL0603FR-0728R7T
1	R5	41.2Ω	Film resolution, 1%	0603	Yageo	RL0603FR-0741R2T
0	R6	NS		1206		
1	R7	390kΩ	Film resolution, 1%	0603	Yageo	RL0603FR-07390KL
1	R8	20kΩ	Film resolution, 1%	0603	Yageo	RL0603FR-0720KL
2	R9A, R9B	200kΩ	Film resolution, 1%	0603	Yageo	RL0603FR-07200KL
2	R10A, R10B	15kΩ	Film resolution, 1%	1206	Yageo	RL1206FR-0715KL
1	R12	0.018Ω	Film resolution, 1%	0805	Yageo	RL0805FR-070R018L
3	R15, R16, R18	0Ω	Film resolution, 1%	0603	Yageo	RL0603FR-070RL
2	R19, R28	6.8kΩ	Film resolution, 1%	0603	Yageo	RL0603FR-076K8L
1	R20	100Ω	Film resolution, 1%	0603	Yageo	RL0603FR-07100RL
5	R21, R40, R42, R44, R46	2MΩ	Film resolution, 1%	0603	Yageo	RL0603FR-072ML
2	R22A, R22B	0.047Ω	Film resolution, 1%	1206	Yageo	RL1206FR-070R047L
1	R23	15Ω	Film resolution, 1%	1206	Yageo	RL1206FR-0715RL
1	R24	4.99kΩ	Film resolution, 1%	0603	Yageo	RL0603FR-074K99L
1	R25	10Ω	Film resolution, 1%	0603	Yageo	RL0603FR-0710RL
1	R26	680Ω	Film resolution, 1%	0603	Yageo	RL0603FR-07680RL
1	R27	4.99Ω	Film resolution, 1%	0805	Yageo	RL0805FR-074R99L
8	R32, R33, R34, R35, R36, R37, R38, R39	75Ω	Film resolution, 1%	0603	Yageo	RL0603FR-0775RL
4	R41, R43, R45, R47	200kΩ	Film resolution, 1%	0603	Yageo	RL0603FR-07200KL
1	T1	55µH	Np:Ns1:Na:Ns2 = 18:6:5:5	EFD25	Chengdu Jinzhichuan	TBSG25-40

**EVL8030-QJ-00B BILL OF MATERIALS (continued)**

Qty	Ref	Value	Description	Package	Manufacturer	Manufacturer PN
1	T2	350 μ H	LAN 10/100/1000 base-T transformer, WE-LAN series	SMD	Wurth	7490220122
1	U1	MP8030	PoE PD with PD interface and high-efficiency, PSR flyback/forward controller	QFN-32 (5mmx6mm)	MPS	MP8030GQJ

EVB TEST RESULTS

$V_{IN} = 54V$, $V_{OUT} = 12V$, $I_{OUT} = 6A$, $T_A = 25^{\circ}C$, unless otherwise noted.

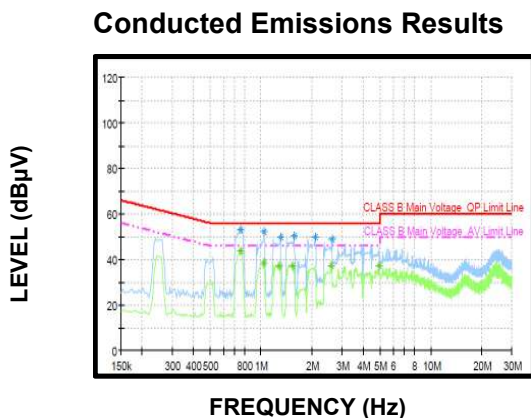
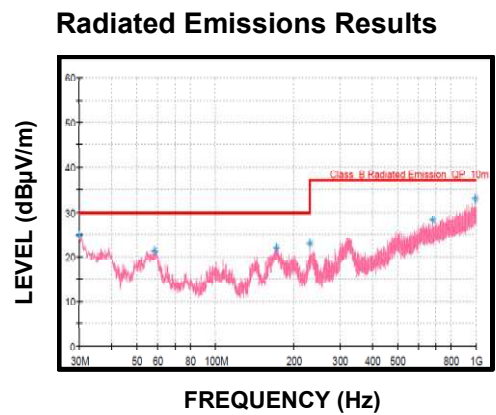
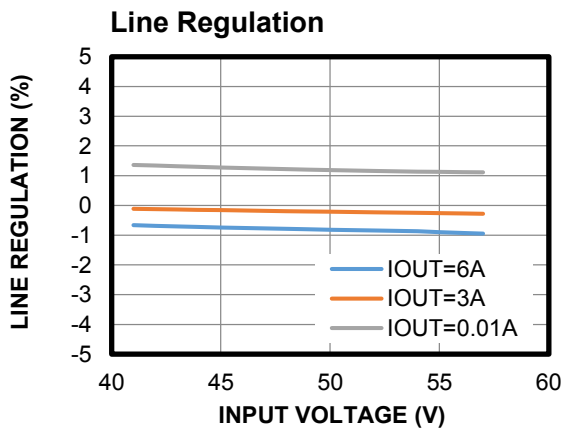
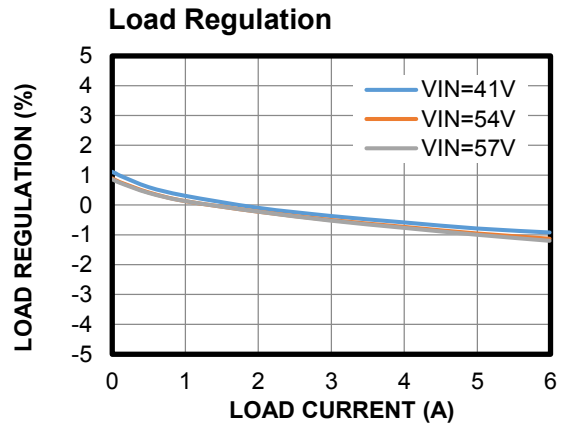
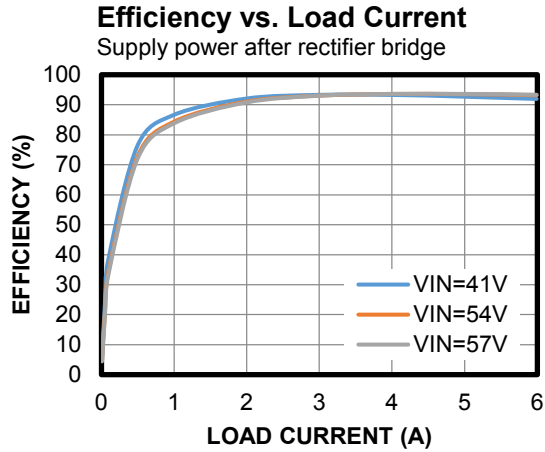

EVB TEST RESULTS (continued)

$V_{IN} = 54V$, $V_{OUT} = 12V$, $I_{OUT} = 6A$, $T_A = 25^{\circ}C$, unless otherwise noted.

Steady State

$I_{OUT} = 0A$

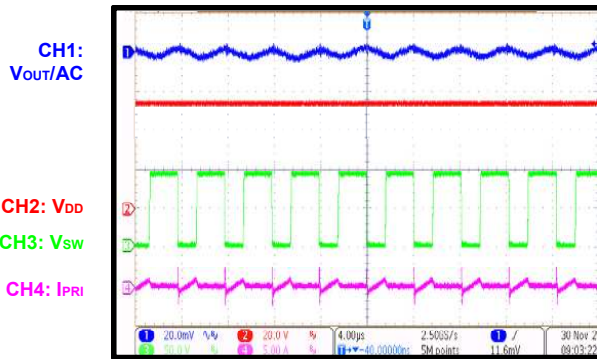

Steady State

$I_{OUT} = 6A$

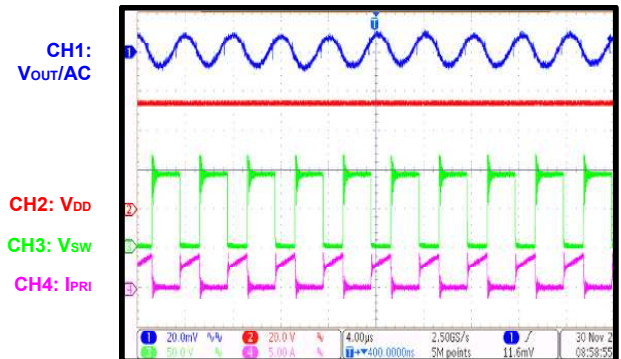

Start-Up through VDD

$I_{OUT} = 0A$

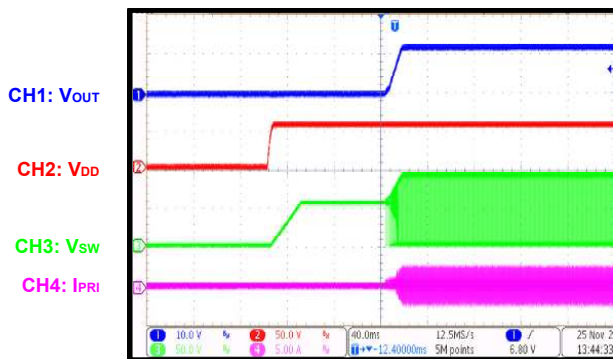

Start-Up through VDD

$I_{OUT} = 6A$

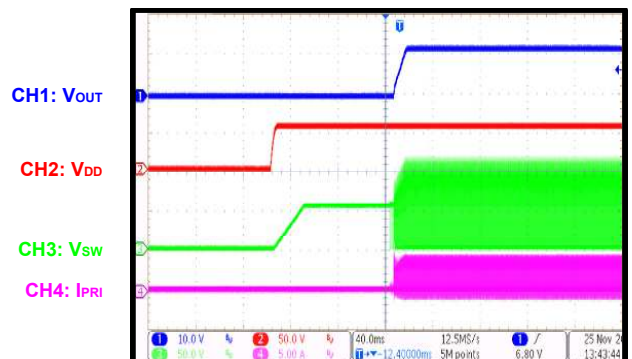

Shutdown through VDD

$I_{OUT} = 0A$

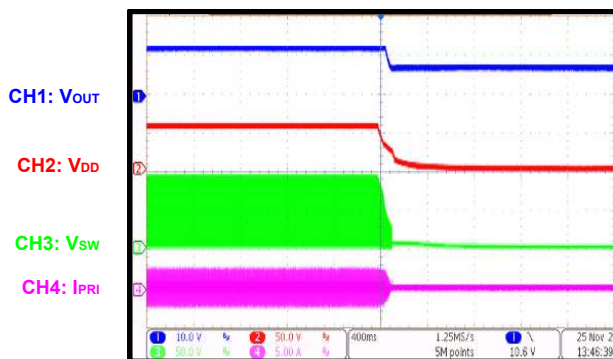

Shutdown through VDD

$I_{OUT} = 6A$

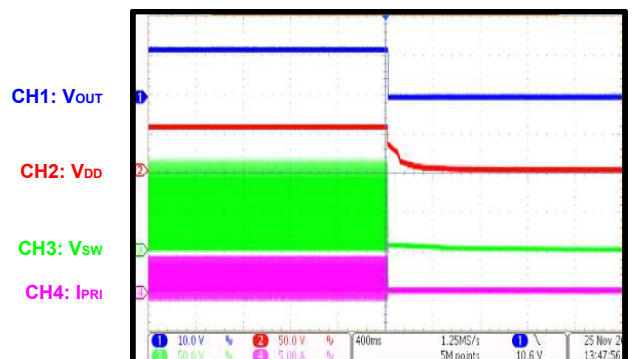

EVB TEST RESULTS (continued)

$V_{IN} = 54V$, $V_{OUT} = 12V$, $I_{OUT} = 6A$, $T_A = 25^{\circ}C$, unless otherwise noted.

SCP Entry
 $I_{OUT} = 0A$ to short

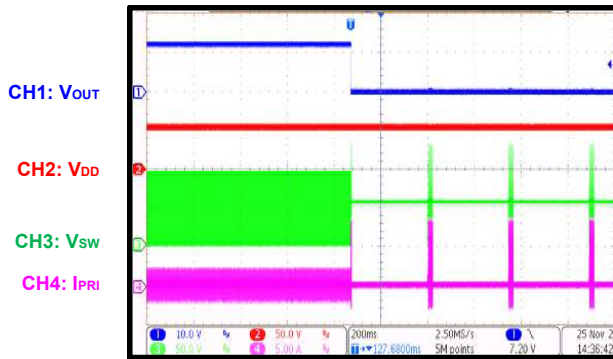

SCP Entry
 $I_{OUT} = 6A$ to short

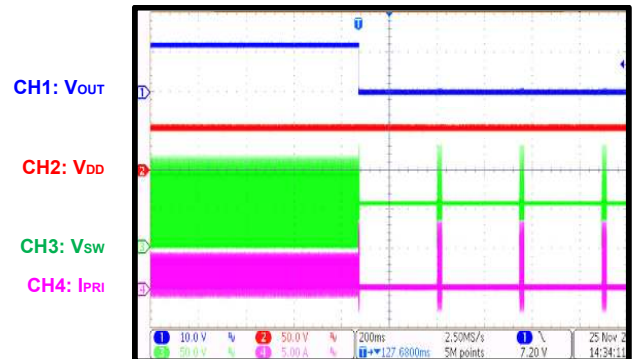

SCP Recovery
 $I_{OUT} = \text{short to } 0A$

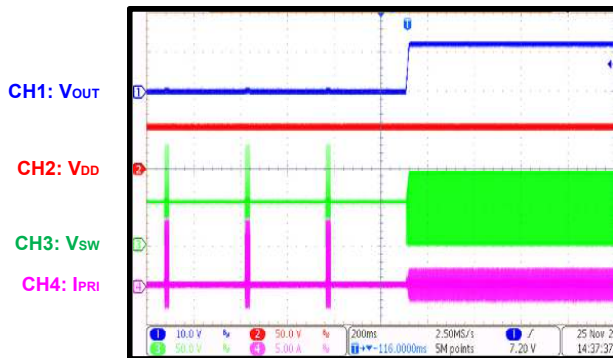

SCP Recovery
 $I_{OUT} = \text{short to } 6A$

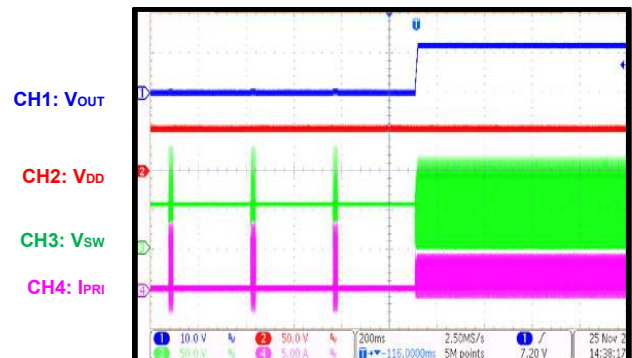

Load Transient
 $I_{OUT} = 0A$ to $3A$, $I_{RAMP} = 25mA/\mu s$

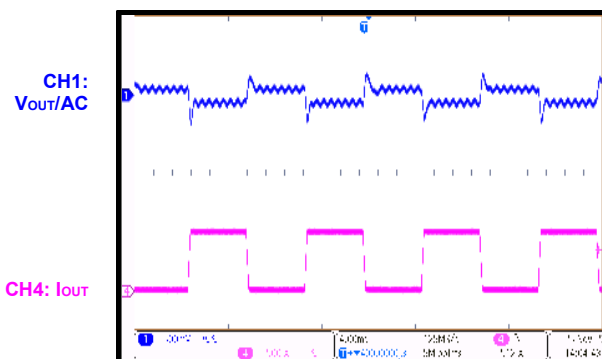

Load Transient
 $I_{OUT} = 3A$ to $6A$, $I_{RAMP} = 25mA/\mu s$

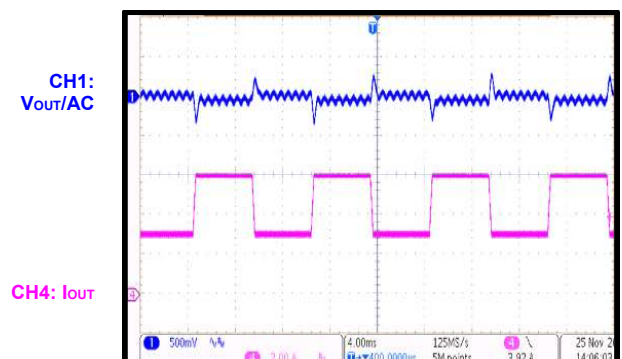

EVB TEST RESULTS (continued)

$V_{IN} = 54V$, $V_{OUT} = 12V$, $I_{OUT} = 6A$, $T_A = 25^{\circ}C$, unless otherwise noted.

Start-Up through PSE

$I_{OUT} = 0A$

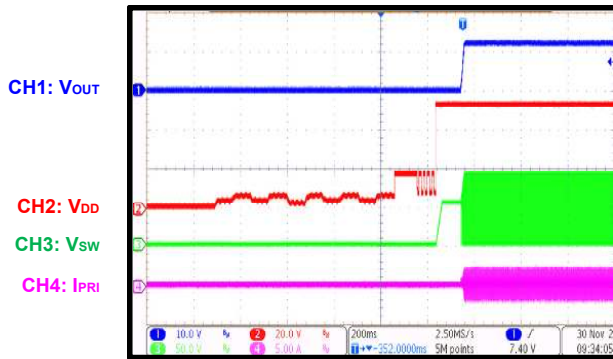

Start-Up through PSE

$I_{OUT} = 6A$



PCB LAYOUT

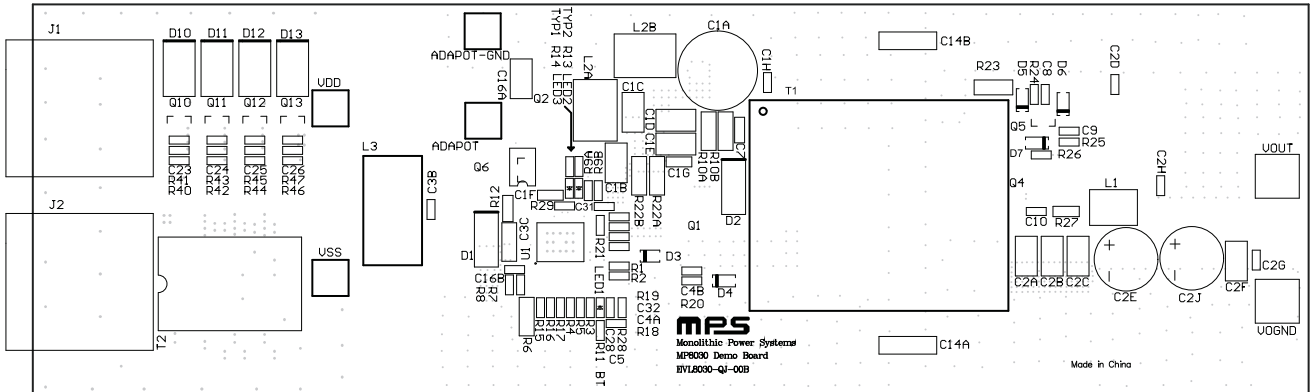

Figure 2: Top Silk

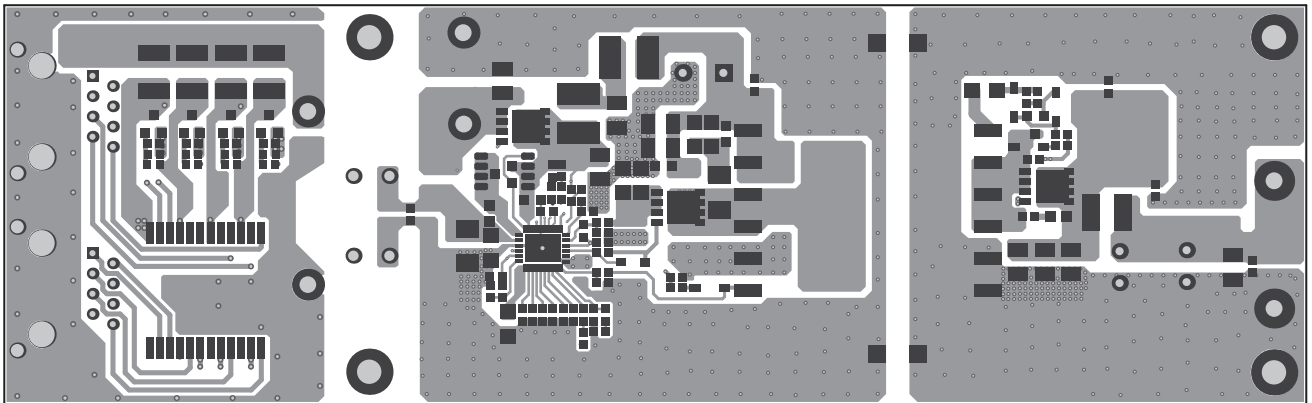

Figure 3: Top Layer

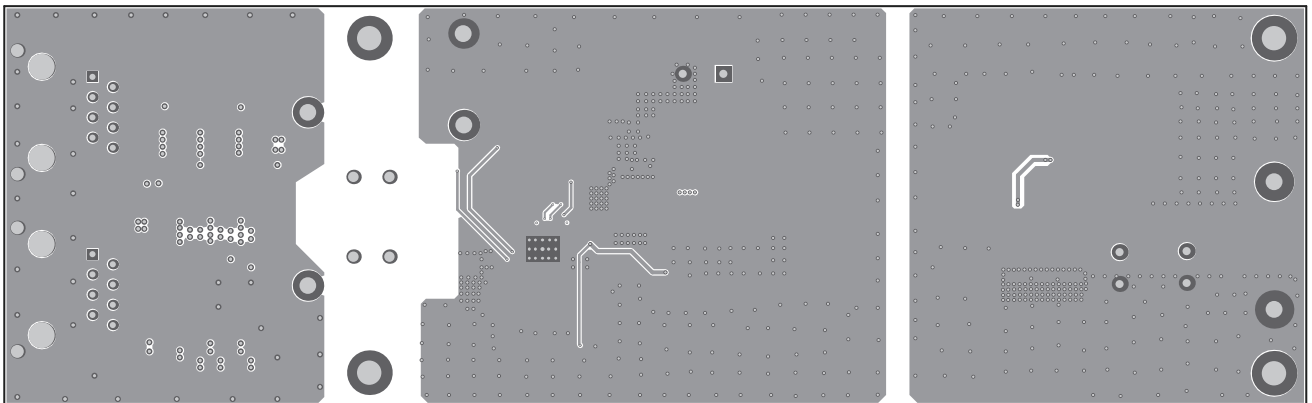

Figure 4: Mid-Layer 1

PCB LAYOUT (continued)

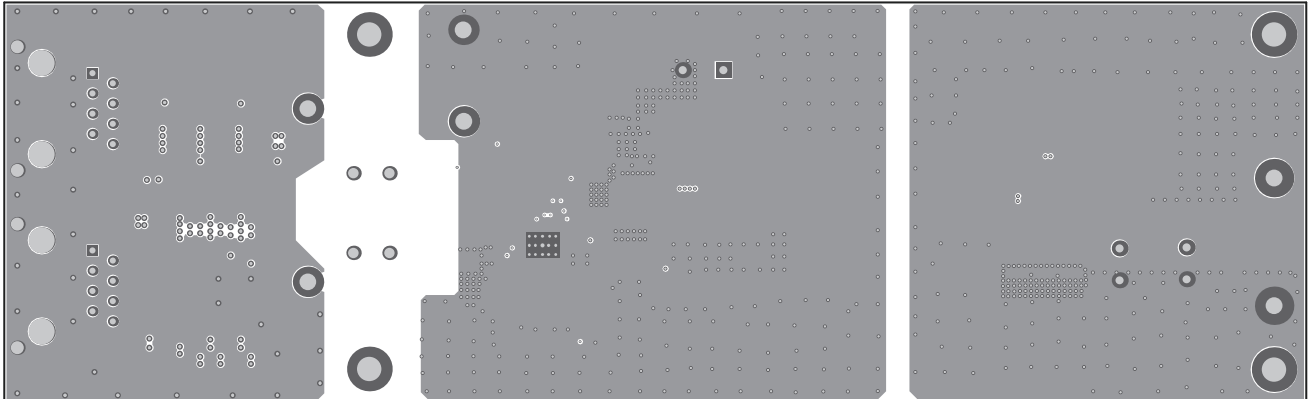

Figure 5: Mid-Layer 2

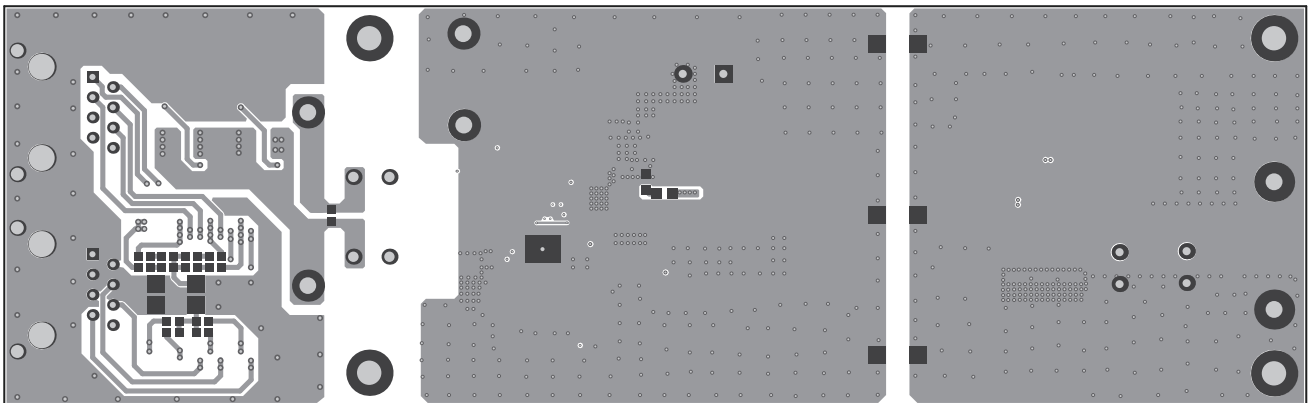

Figure 6: Bottom Layer

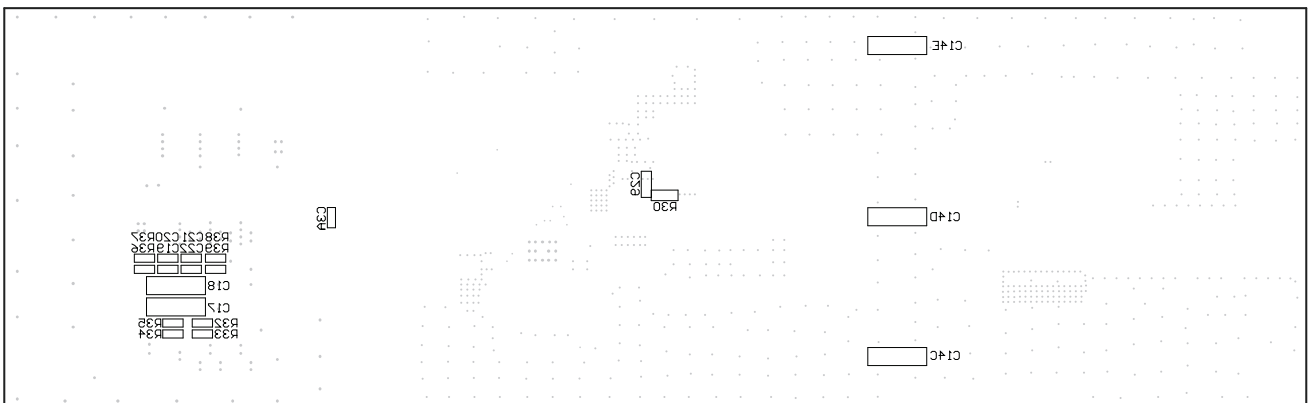

Figure 7: Bottom Silk

Notice: The information in this document is subject to change without notice. Please contact MPS for current specifications. Users should warrant and guarantee that third-party Intellectual Property rights are not infringed upon when integrating MPS products into any application. MPS will not assume any legal responsibility for any said applications.