

STRADELLA-HB-M

~60° medium beam for industrial applications

SPECIFICATION:

Dimensions	13.9 x 13.9 mm
Height	5.7 mm
Fastening	pin
ROHS compliant	yes ⓘ

MATERIALS:

Component	Type	Material	Colour	Finish
STRADELLA-HB-M	Single lens	PMMA	clear	

ORDERING INFORMATION:

Component	Qty in box	MOQ	MPQ	Box weight (kg)
C15246_STRADELLA-HB-M » Box size: 480 x 250 x 390 mm	24000	1000	1000	9.9



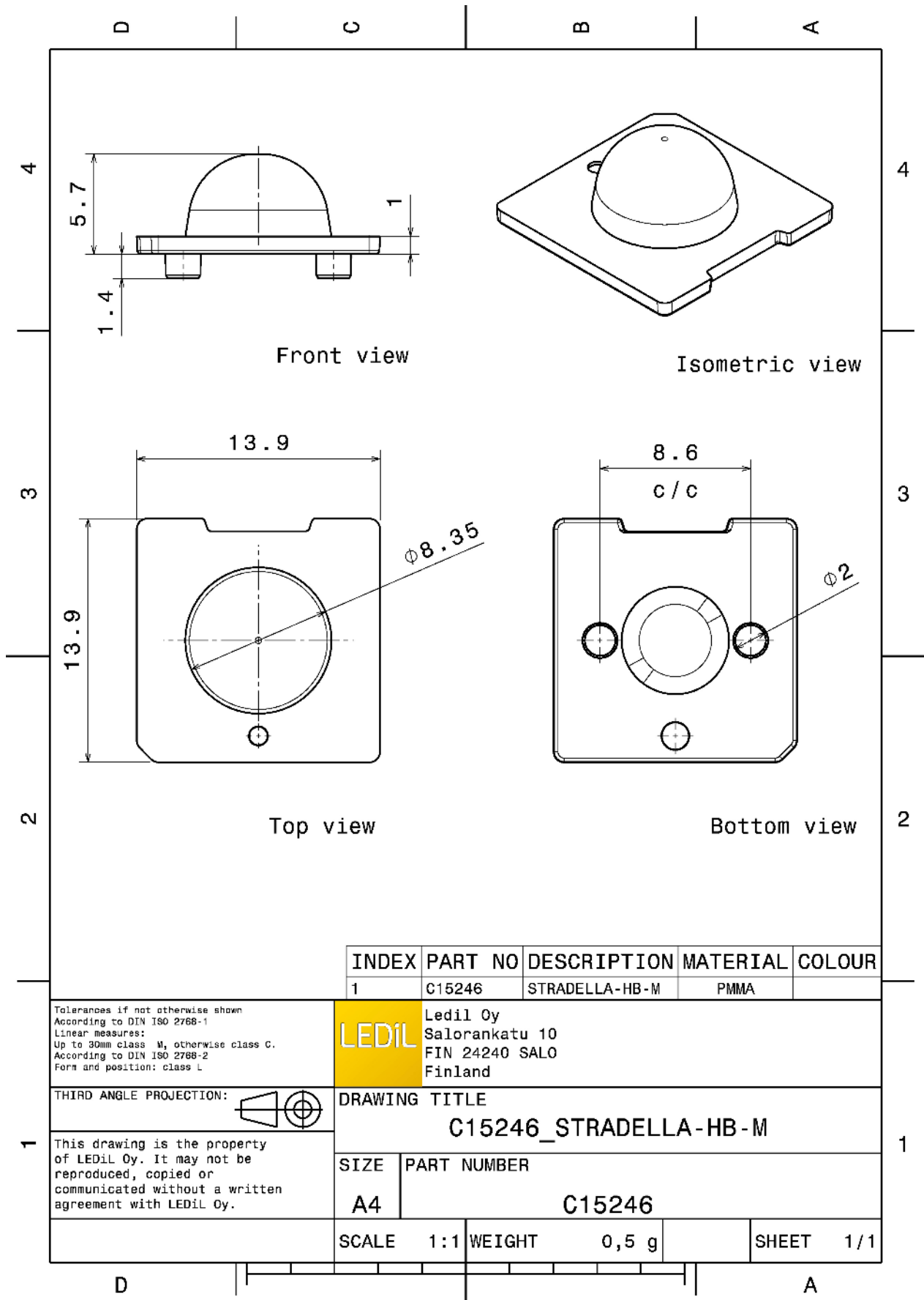

INDEX	PART NO	DESCRIPTION	MATERIAL	COLOUR
1	C15246	STRADELLA-HB-M	PMMA	

Tolerances if not otherwise shown
According to DIN ISO 2768-1
Linear measures:
Up to 30mm class M, otherwise class C.
According to DIN ISO 2768-2
Form and position: class L

LEDiL Ledil Oy
Salorankatu 10
FIN 24240 SALO
Finland

THIRD ANGLE PROJECTION:

DRAWING TITLE
C15246_STRADELLA-HB-M



This drawing is the property of LEDiL Oy. It may not be reproduced, copied or communicated without a written agreement with LEDiL Oy.

SIZE	PART NUMBER
A4	C15246

SCALE	1:1	WEIGHT	0,5 g	SHEET	1/1
-------	-----	--------	-------	-------	-----

See also our general installation guide: www.ledil.com/installation_guide

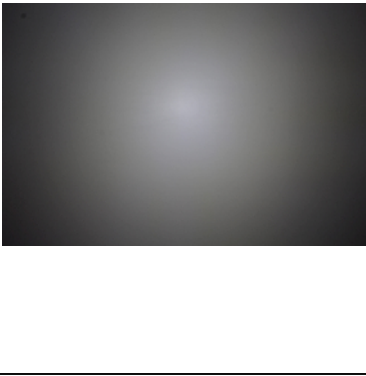
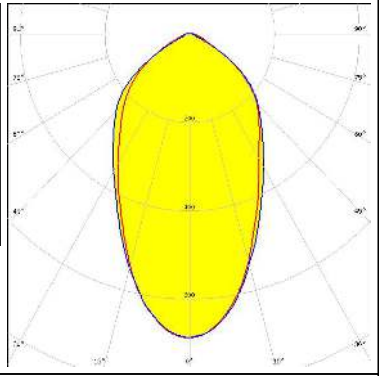
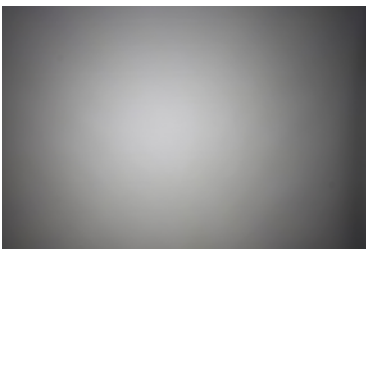
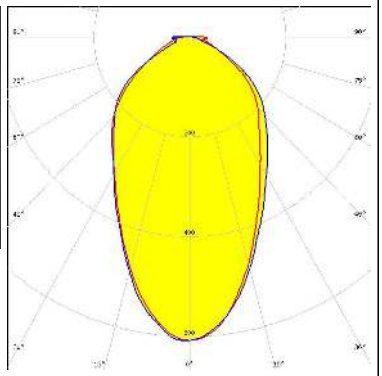
OPTICAL RESULTS (MEASURED):

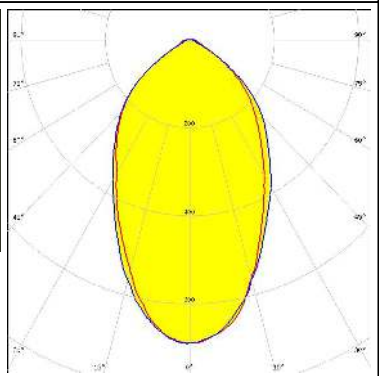
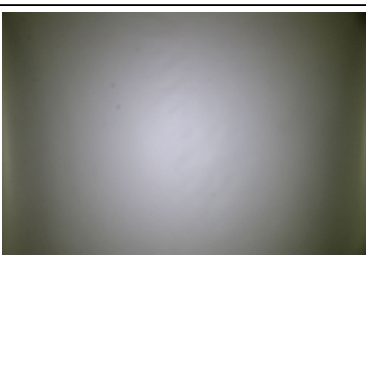
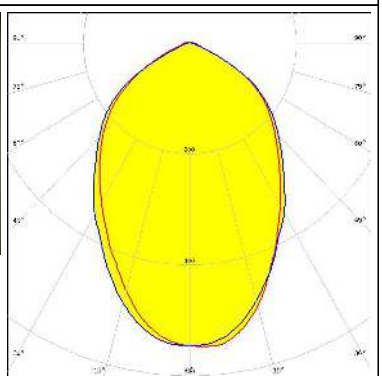
<p>CREE → LED</p> <p>LED J Series 3030 FWHM / FWTM 60.0° / 124.0° Efficiency 98 % Peak intensity 0.7 cd/lm LEDs/each optic 1 Light colour White Required components:</p>		
<p>CREE → LED</p> <p>LED XT-E FWHM / FWTM 62.0° / 133.0° Efficiency 94 % Peak intensity 0.6 cd/lm LEDs/each optic 1 Light colour White Required components:</p>		
<p>NICHIA</p> <p>LED NVSW219D FWHM / FWTM 61.0° / 120.0° Efficiency 94 % Peak intensity 0.7 cd/lm LEDs/each optic 1 Light colour White Required components:</p>		
<p>NICHIA</p> <p>LED NVSW319B FWHM / FWTM 78.0° / 132.0° Efficiency 94 % Peak intensity 0.6 cd/lm LEDs/each optic 1 Light colour White Required components:</p>		

OPTICAL RESULTS (MEASURED):

SAMSUNG

LED LH181B
FWHM / FWTM 58.0° / 117.0°
Efficiency 94 %
Peak intensity 0.7 cd/lm
LEDs/each optic 1
Light colour White
Required components:

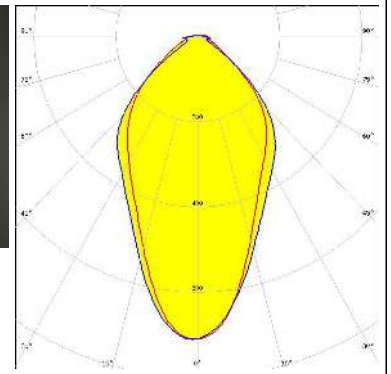

OPTICAL RESULTS (SIMULATED):

CREE LED

LED XP-G2 HE
 FWHM / FWTM 70.0° / 130.0°
 Efficiency 95 %
 Peak intensity 0.6 cd/lm
 LEDs/each optic 1
 Light colour White
 Required components:

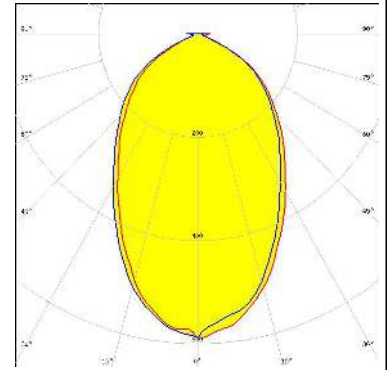

CREE LED

LED XP-G3
 FWHM / FWTM 73.0° / 134.0°
 Efficiency 94 %
 Peak intensity 0.6 cd/lm
 LEDs/each optic 1
 Light colour White
 Required components:

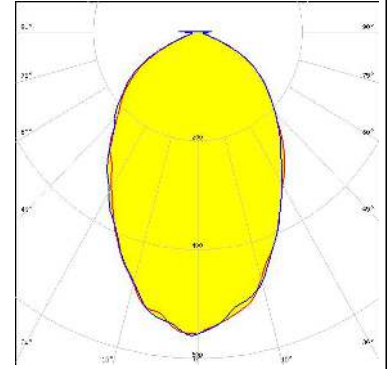

LUMILEDS

LED LUXEON IR Domed 150
 FWHM / FWTM 73.0° / 180.0°
 Efficiency 96 %
 Peak intensity 0.5 cd/lm
 LEDs/each optic 1
 Light colour IR
 Required components:

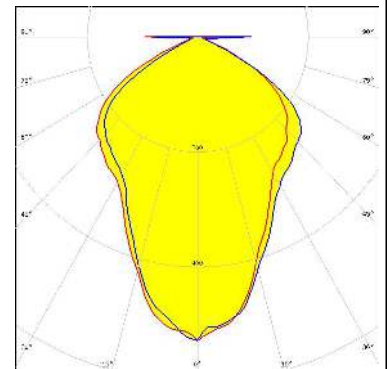

LUMILEDS

LED LUXEON IR Domed 90
 FWHM / FWTM 47.0° / 102.0°
 Efficiency 94 %
 LEDs/each optic 1
 Light colour White
 Required components:

OPTICAL RESULTS (SIMULATED):

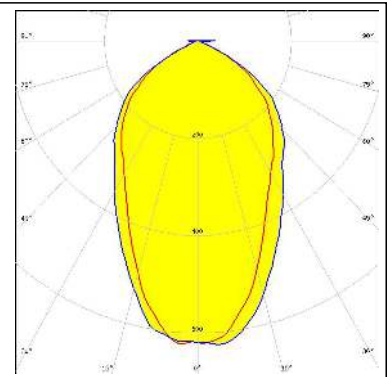
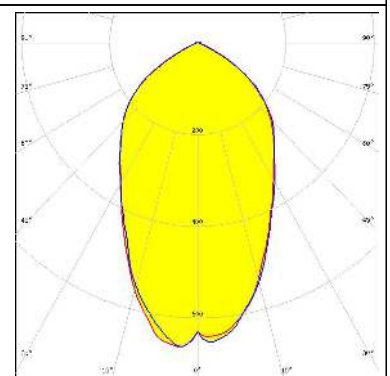
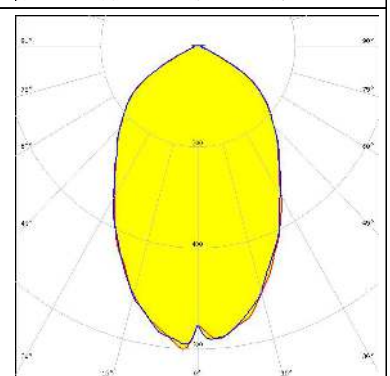
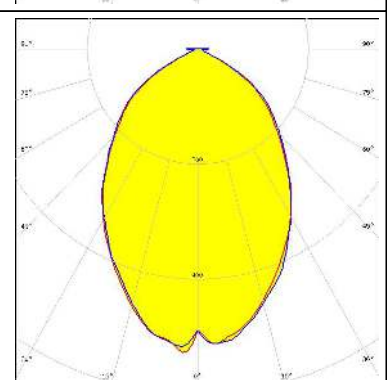
<p>NICHIA</p> <p>LED NF2W585AR-P8</p> <p>FWHM / FWTM 60.0 + 70.0° / 128.0 + 127.0°</p> <p>Efficiency 96 %</p> <p>Peak intensity 0.6 cd/lm</p> <p>LEDs/each optic 1</p> <p>Light colour White</p> <p>Required components:</p>	
<p>NICHIA</p> <p>LED NFSx757G</p> <p>FWHM / FWTM 64.0° / 125.0°</p> <p>Efficiency 96 %</p> <p>Peak intensity 0.7 cd/lm</p> <p>LEDs/each optic 1</p> <p>Light colour White</p> <p>Required components:</p>	
<p>NICHIA</p> <p>LED NVSW219F</p> <p>FWHM / FWTM 70.0° / 128.0°</p> <p>Efficiency 95 %</p> <p>Peak intensity 0.6 cd/lm</p> <p>LEDs/each optic 1</p> <p>Light colour White</p> <p>Required components:</p>	
<p>NICHIA</p> <p>LED NVSW519A</p> <p>FWHM / FWTM 78.0° / 127.0°</p> <p>Efficiency 91 %</p> <p>Peak intensity 0.5 cd/lm</p> <p>LEDs/each optic 1</p> <p>Light colour White</p> <p>Required components:</p>	

OPTICAL RESULTS (SIMULATED):

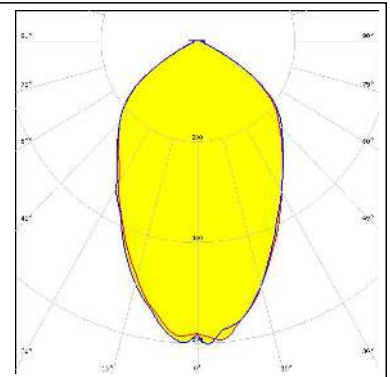
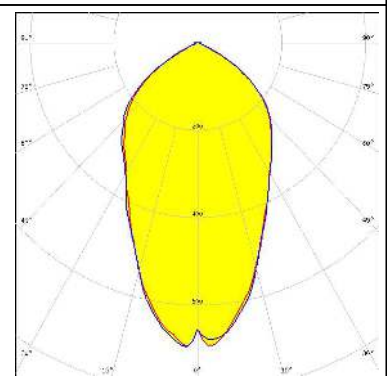
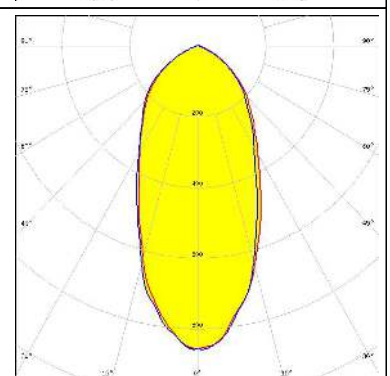
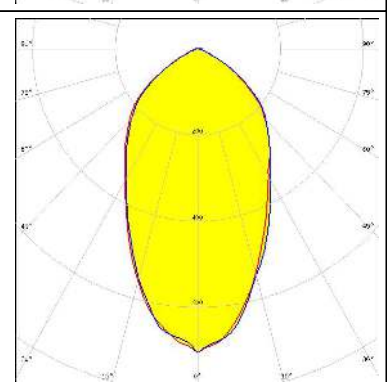
<p>NICHIA</p> <p>LED NVSxx19B/NVSxx19C</p> <p>FWHM / FWTM 68.0° / 126.0°</p> <p>Efficiency 94 %</p> <p>Peak intensity 0.6 cd/lm</p> <p>LEDs/each optic 1</p> <p>Light colour White</p> <p>Required components:</p>	
<p>OSRAM Opto Semiconductors</p> <p>LED OSCONIQ C 2424</p> <p>FWHM / FWTM 60.0° / 125.0°</p> <p>Efficiency 97 %</p> <p>Peak intensity 0.7 cd/lm</p> <p>LEDs/each optic 1</p> <p>Light colour White</p> <p>Required components:</p>	
<p>OSRAM Opto Semiconductors</p> <p>LED OSCONIQ P 3030</p> <p>FWHM / FWTM 50.0° / 121.0°</p> <p>Efficiency 97 %</p> <p>Peak intensity 0.9 cd/lm</p> <p>LEDs/each optic 1</p> <p>Light colour White</p> <p>Required components:</p>	
<p>OSRAM Opto Semiconductors</p> <p>LED OSCONIQ P 3737 (2W version)</p> <p>FWHM / FWTM 59.0° / 124.0°</p> <p>Efficiency 94 %</p> <p>Peak intensity 0.7 cd/lm</p> <p>LEDs/each optic 1</p> <p>Light colour White</p> <p>Required components:</p>	

OPTICAL RESULTS (SIMULATED):

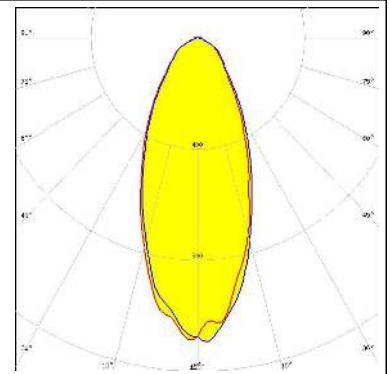
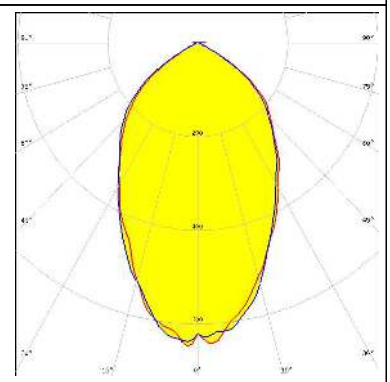
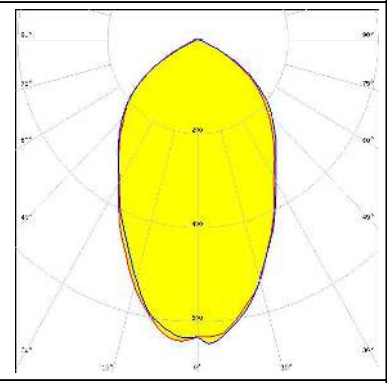
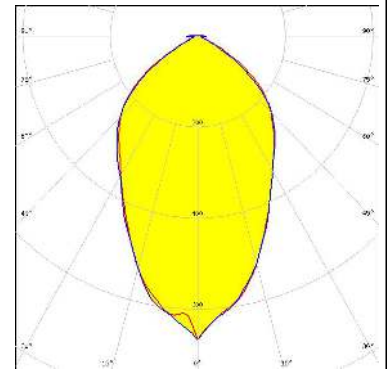
<p>OSRAM Opto Semiconductors</p> <p>LED: OSLO[®] SSL 80</p> <p>FWHM / FWTM: 44.0° / 104.0°</p> <p>Efficiency: 96 %</p> <p>Peak intensity: 1.1 cd/lm</p> <p>LEDs/each optic: 1</p> <p>Light colour: White</p> <p>Required components:</p>	
<p>SAMSUNG</p> <p>LED: LH351B</p> <p>FWHM / FWTM: 63.0° / 120.0°</p> <p>Efficiency: 93 %</p> <p>Peak intensity: 0.7 cd/lm</p> <p>LEDs/each optic: 1</p> <p>Light colour: White</p> <p>Required components:</p>	
<p>SEOUL SEMICONDUCTOR</p> <p>LED: Z5M1/Z5M2</p> <p>FWHM / FWTM: 64.0° / 127.0°</p> <p>Efficiency: 94 %</p> <p>Peak intensity: 0.7 cd/lm</p> <p>LEDs/each optic: 1</p> <p>Light colour: White</p> <p>Required components:</p>	
<p>SEOUL SEMICONDUCTOR</p> <p>LED: Z8Y22T</p> <p>FWHM / FWTM: 62.0° / 121.0°</p> <p>Efficiency: 94 %</p> <p>Peak intensity: 0.7 cd/lm</p> <p>LEDs/each optic: 1</p> <p>Light colour: White</p> <p>Required components:</p>	

GENERAL INFORMATION:

NOTE: The typical beam angle will be changed by different color, chip size and chip position tolerance. The typical total beam angle is the full angle measured where the luminous intensity is half of the peak value.

MATERIALS:

As part of our continuous research and improvement processes, and to ensure the best possible quality and availability of our products, LEDiL reserves the right to change material grades without notice.

PRODUCT DATA USER AGREEMENT AND DISCLAIMER:

The measured data in the provided downloadable LEDiL Product Datasheets and Mechanical 2D-Drawings is rounded and provided as reference for planning. LEDiL Oy's optical specifications have been verified by conducting performance testing of the products in accordance with the company's quality system. The reported data are averaged results of multiple measurements with typical variation. LEDiL Oy reserves the right to without prior notification make changes and improvements to its products.

LEDiL Oy assumes neither warranty, nor guarantee nor any other liability of any kind for the contents and correctness of the provided data. The provided data has been generated with highest diligence but the provided data may in reality not represent the complete possible variation range of all intrinsic parameters. Therefore, in certain cases a deviation from the provided data could occur.

LEDiL Oy reserves the right to undertake technical changes of its products without further notification which could lead to changes in the provided data. LEDiL Oy assumes no liability of any kind for the possible deviation from any provided data or any other damage resulting from the usage of the provided data.

The user agrees to this disclaimer and user agreement with the download or usage of the provided files.

LEDiL Oy

Joensuunkatu 13
FI-24240 SALO
Finland

LEDiL Inc.

228 West Page Street
Suite D
Sycamore IL 60178
USA

Ledil Optics Technology (Shenzhen) Co., Ltd.

405 , Block B
Casic Motor Building
Shenzhen 518057
P.R.CHINA

Local sales and technical support

[www.ledil.com/
where_to_buy](http://www.ledil.com/where_to_buy)

Shipping locations

Salo, Finland
Hong Kong, China

Distribution Partners

[www.ledil.com/
where_to_buy](http://www.ledil.com/where_to_buy)