

CMPA2735015S

15 W, 2.7 - 3.5 GHz, GaN MMIC, Power Amplifier

Description

Cree's CMPA2735015S is a gallium nitride (GaN) High Electron Mobility Transistor (HEMT) based monolithic microwave integrated circuit (MMIC). GaN has superior properties compared to silicon or gallium arsenide, including higher breakdown voltage, higher saturated electron drift velocity and higher thermal conductivity. GaN HEMTs also offer greater power density and wider bandwidths compared to Si and GaAs transistors. This MMIC contains a two-stage reactively matched amplifier design approach enabling high power and power added efficiency to be achieved in a 5mm x 5mm, surface mount (QFN package).

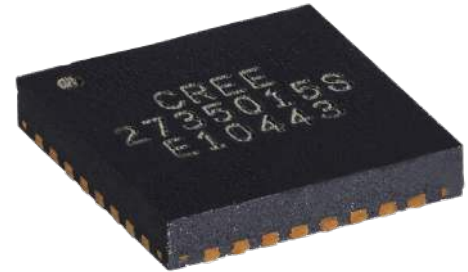

PN: CMPA2735015S
Package: 5x5 mm

Typical Performance Over 2.7 - 3.5 GHz ($T_c = 25^\circ\text{C}$)

Parameter	2.7 GHz	2.9 GHz	3.1 GHz	3.3 GHz	3.5 GHz	Units
Small Signal Gain	35	34	34	34	33	dB
Saturated Output Power	21	21	24	25	22	W
Power Gain	27.3	27.2	27.9	27.9	27.5	dB
Power Added Efficiency	56	53	49	48	50	%

Note: $P_{IN} = 16\text{ dBm}$, Pulse Width = 500 μs ; Duty Cycle = 10%

Features

- 33 dB Small Signal Gain
- 21 W Typical P_{SAT}
- Operation up to 50 V
- High Breakdown Voltage
- High Temperature Operation
- 5 mm x 5 mm Total Product Size

Applications

- Civil and Military Pulsed Radar Amplifiers

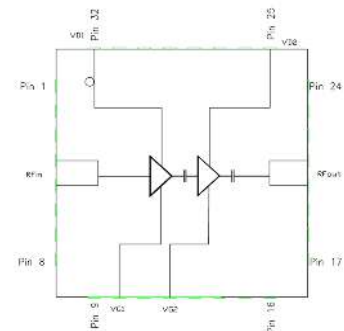

Figure 1.



Absolute Maximum Ratings (not simultaneous) at 25 °C

Parameter	Symbol	Rating	Units	Conditions
Drain-source Voltage	V_{DSS}	150	V	
Gate-source Voltage	V_{GS}	-10, +2	V	
Storage Temperature	T_{STG}	-65, +150	°C	
Operating Junction Temperature	T_J	225	°C	
Maximum Forward Gate Current	I_{GMAX}	0.0038	A	
Maximum Drain Current ¹	I_{DMAX}	3.53	A	
Thermal Resistance, Junction to Case ⁵	$R_{\theta JC}$	5.05	°C/W	85°C
Case Operating Temperature ^{3,4}	T_C	-40, +95	°C	25°C Ambient
Soldering Temperature ²	T_S	245	°C	

Notes:

¹ Current limit for long term, reliable operation² Refer to the Application Note on soldering at wolfspeed.com/rf/document-library³ Simulated at $P_{DISS} = 15$ W⁴ T_C = Case temperature for the device. It refers to the temperature at the ground tab underneath the package. The PCB will add additional thermal resistance⁵ Pulsed (300 μ s, 20%), for steady state operation, the $R_{\theta JC}$ increases to 7.2 °C/W**Electrical Characteristics (Frequency = 2.9 GHz to 3.5 GHz unless otherwise stated; $T_C = 25$ °C)**

Characteristics	Symbol	Min.	Typ.	Max.	Units	Conditions
DC Characteristics						
Gate Threshold Voltage	$V_{GS(TH)}$	-3.8	-3.0	-2.3	V	$V_{DS} = 10$ V, $I_D = 3$ mA
Gate Quiescent Voltage	$V_{GS(Q)}$	-	-2.7	-	V_{DC}	$V_{DD} = 50$ V, $I_{DQ} = 80$ mA
Saturated Drain Current ¹	I_{DS}	2.5	3.5	-	A	$V_{DS} = 6.0$ V, $V_{GS} = 2.0$ V
Drain-Source Breakdown Voltage	V_{BD}	100	-	-	V	$V_{GS} = -8$ V, $I_D = 3$ mA
RF Characteristics^{2,3}						
Small Signal Gain ₁	S21	-	35	-	dB	$V_{DD} = 50$ V, $I_{DQ} = 80$ mA, Freq = 2.7 GHz
Small Signal Gain ₂	S21	-	34	-	dB	$V_{DD} = 50$ V, $I_{DQ} = 80$ mA, Freq = 3.1 GHz
Small Signal Gain ₃	S21	-	33	-	dB	$V_{DD} = 50$ V, $I_{DQ} = 80$ mA, Freq = 3.5 GHz
Power Output ₁	P_{OUT}	-	21	-	W	$V_{DD} = 50$ V, $I_{DQ} = 80$ mA, $P_{IN} = 16$ dBm, Freq = 2.7 GHz
Power Output ₂	P_{OUT}	-	24	-	W	$V_{DD} = 50$ V, $I_{DQ} = 80$ mA, $P_{IN} = 16$ dBm, Freq = 3.1 GHz
Power Output ₃	P_{OUT}	-	22	-	W	$V_{DD} = 50$ V, $I_{DQ} = 80$ mA, $P_{IN} = 16$ dBm, Freq = 3.5 GHz
Power Added Efficiency ₁	PAE	-	56	-	%	$V_{DD} = 50$ V, $I_{DQ} = 80$ mA, Freq = 2.7 GHz
Power Added Efficiency ₂	PAE	-	49	-	%	$V_{DD} = 50$ V, $I_{DQ} = 80$ mA, Freq = 3.1 GHz
Power Added Efficiency ₃	PAE	-	50	-	%	$V_{DD} = 50$ V, $I_{DQ} = 80$ mA, Freq = 3.5 GHz
Power Gain	G_P	-	27	-	dB	$V_{DD} = 50$ V, $I_{DQ} = 80$ mA
Input Return Loss	S11	-	-8	-	dB	$V_{DD} = 50$ V, $I_{DQ} = 80$ mA
Output Return Loss	S22	-	-7	-	dB	$V_{DD} = 50$ V, $I_{DQ} = 80$ mA
Output Mismatch Stress	VSWR	-	-	5 : 1	Ψ	No damage at all phase angles, $V_{DD} = 50$ V, $I_{DQ} = 80$ mA, $P_{OUT} = 15$ W Pulsed

Notes:

¹ Scaled from PCM data² All data tested in CMPA2735015S-AMP1³ Pulse Width = 500 μ s; Duty Cycle = 10%



Typical Performance of the CMPA2735015S

Figure 1. Gain and Return Loss vs Frequency of the CMPA2735015S Measured in CMPA2735015S-AMP1 Amplifier Circuit
 $V_{DD} = 50\text{ V}, I_{DQ} = 0.08\text{ A}$

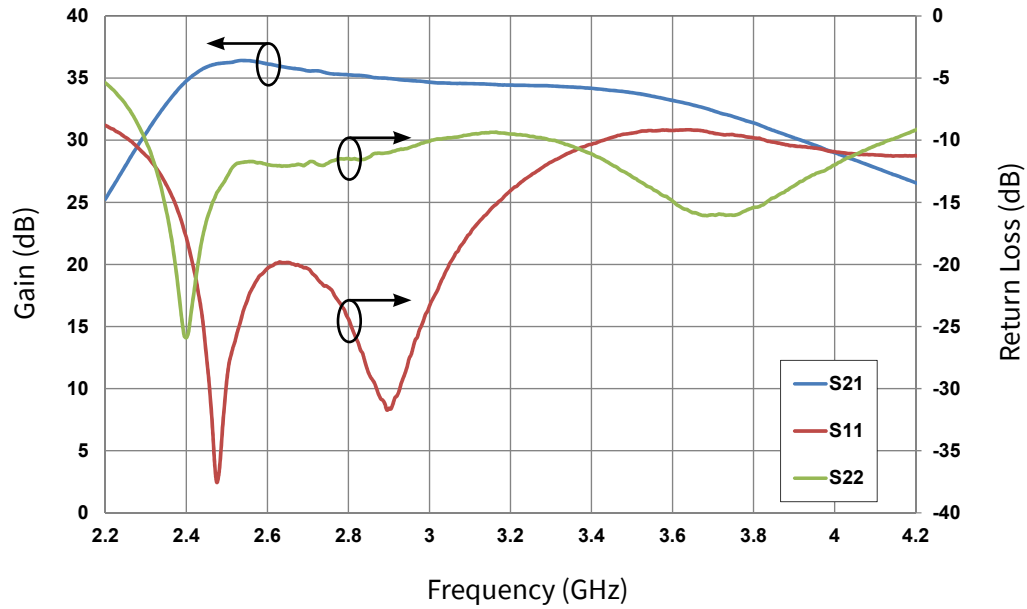
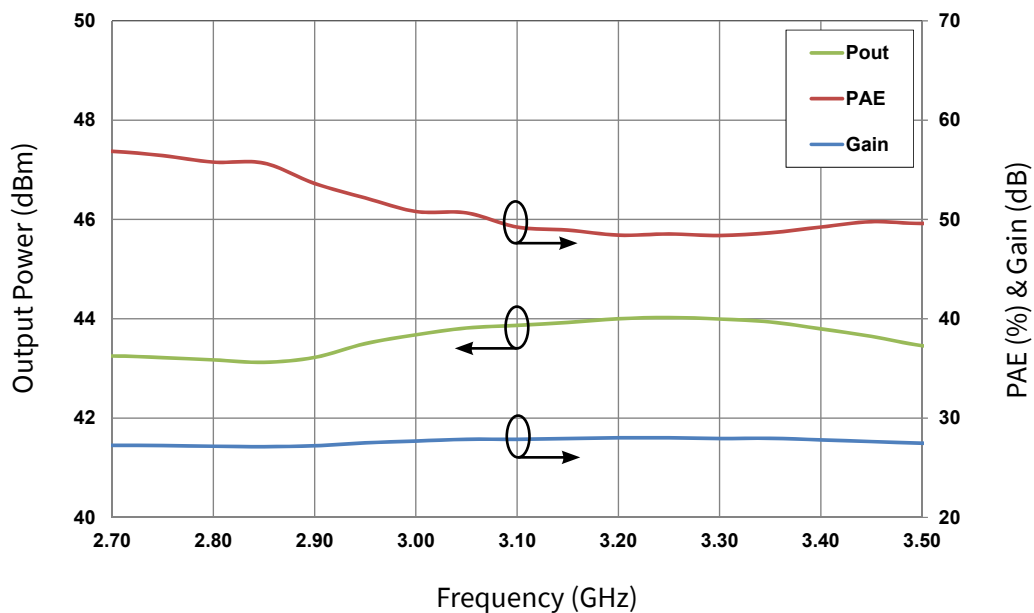

Figure 2. Output Power, Gain and PAE vs Frequency of the CMPA2735015S Measured in CMPA2735015S-AMP1 Amplifier Circuit
 $V_{DD} = 50\text{ V}, I_{DQ} = 0.08\text{ A}, \text{Pulse Width} = 500\ \mu\text{s}, \text{Duty Cycle} = 10\%$





Typical Performance of the CMPA2735015S

Figure 3. Gain and Power Added Efficiency vs Output Power Measured in CMPA2735015S-AMP1 Amplifier Circuit
 $V_{DD} = 50\text{ V}$, $I_{DQ} = 0.08\text{ A}$, Frequency = 2.7 GHz

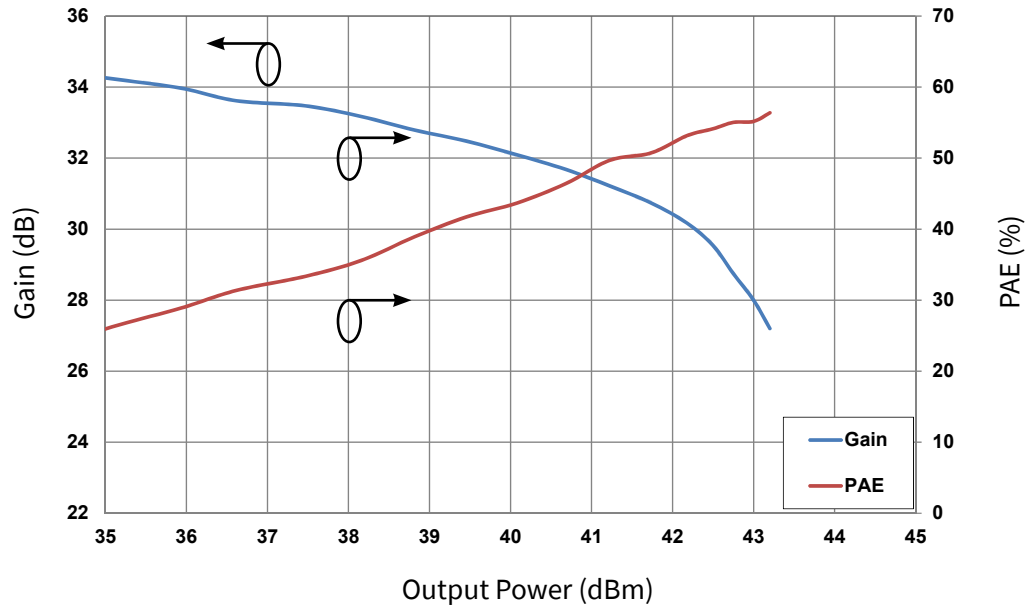
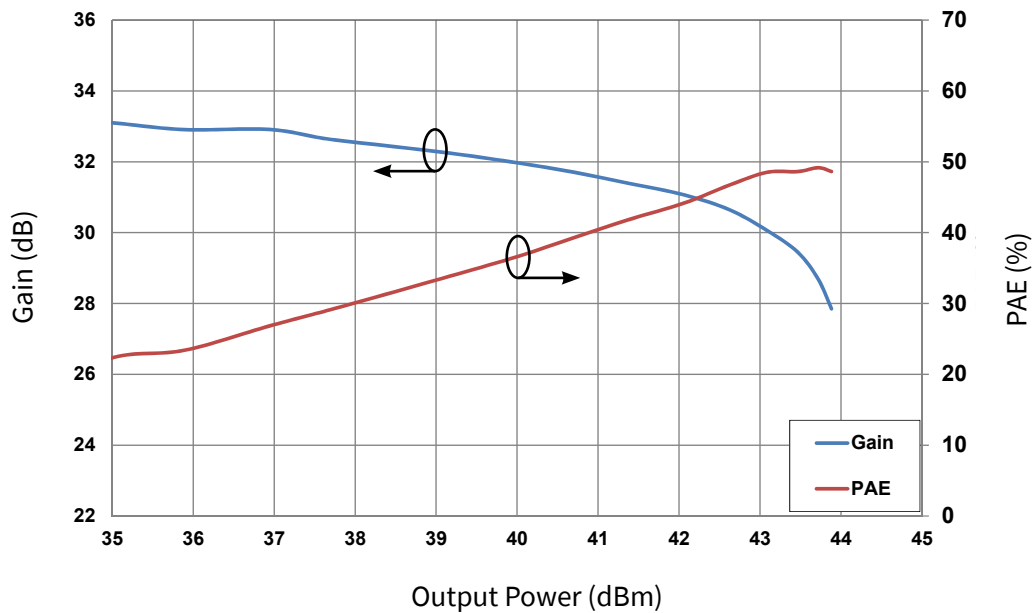

Figure 4. Gain and Power Added Efficiency vs Output Power Measured in CMPA2735015S-AMP1 Amplifier Circuit
 $V_{DD} = 50\text{ V}$, $I_{DQ} = 0.08\text{ A}$, Frequency = 3.1 GHz





Typical Performance of the CPA2735015S

**Figure 5. Gain and Power Added Efficiency vs Output Power
Measured in CPA2735015S-AMP1 Amplifier Circuit
 $V_{DD} = 50\text{ V}$, $I_{DQ} = 0.08\text{ A}$, Frequency = 3.5 GHz**

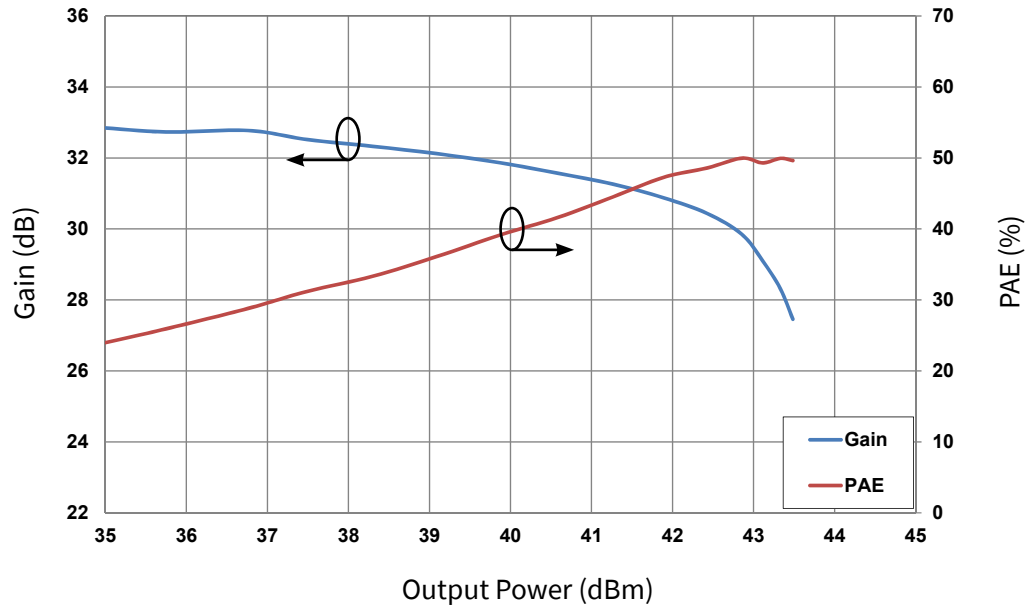

**CMPA2735015S-AMP1 Demonstration Amplifier Circuit Bill of Materials**

Designator	Description	Qty
C1, C4, C10, C11	CAP, 470pF, 100V, 0603	1
C2, C3	CAP, 100pF, 100V, 0603	1
C5, C6, C8, C9	CAP, 10pF, 100V, 0402	1
C7	CAP, 33uF, 50V, ELECT, MVY, SMD	1
C12,C13	CAP, 10uF, 16V, TANTALUM, SMD	2
R1, R2	RES, 100Ohm, 1/16W, 0603	2
J1, J2	CONNECTOR, N-TYPE, FEMALE, W/0.500 SMA FLNG	1
J3, J4	CONNECTOR, HEADER, RT>PLZ .1CEN LK 5POS	1
-	PCB, RO4350B, E _r = 3.48, h = 10 mil	1
Q1	CMPA2735015S	1



CMPA2735015S-AMP1 Demonstration Amplifier Circuit Schematic

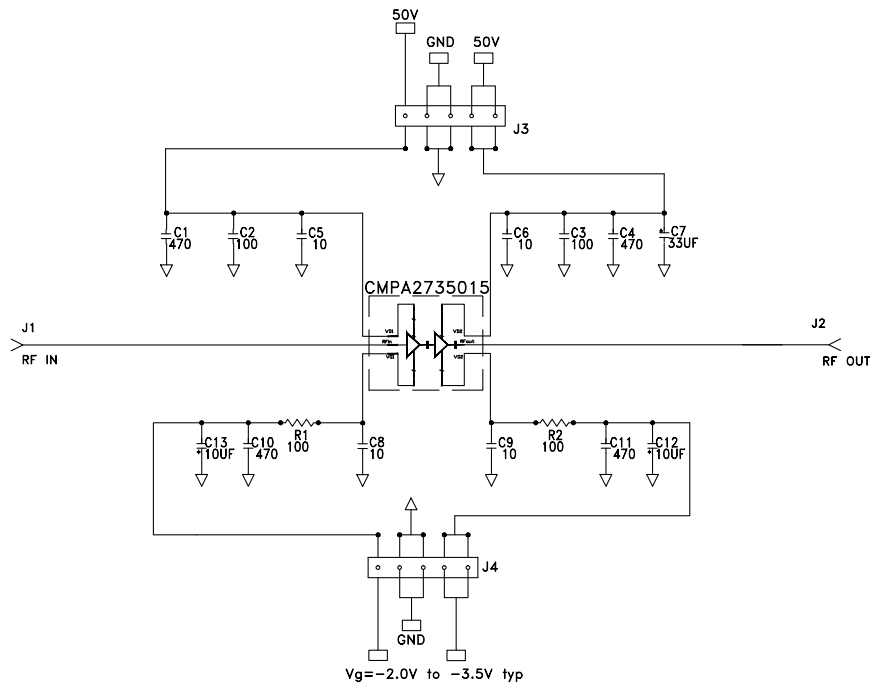

CMPA2735015S-AMP1 Demonstration Amplifier Circuit Outline

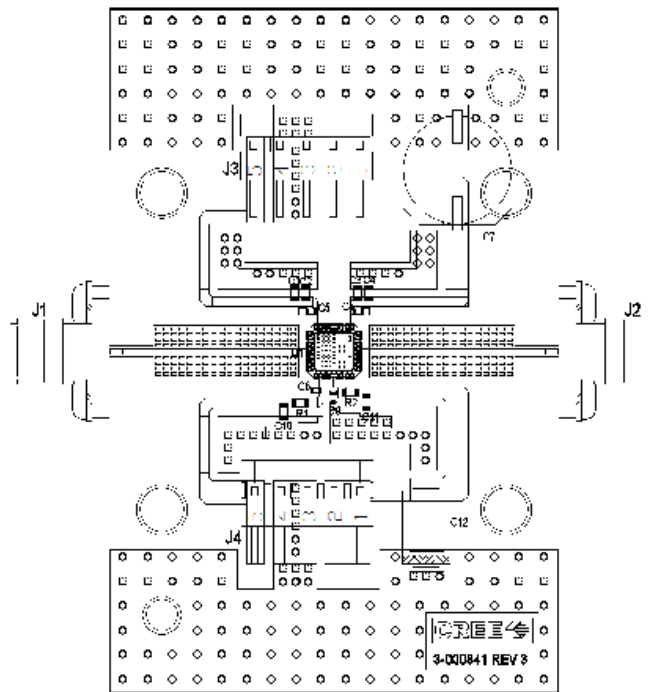



Product Dimensions CMPA2735015S (Package)

SYMBOL	MIN. NOM. MAX.			NOTE
	A	0.80	0.86	
A1	0.00	0.03	0.06	
A3	0.20 REF.			
⌀	0		12	2
K	0.17 MIN.			
D	5.0 BSC			
E	5.0 BSC			

SYMBOL	0.50mm LEAD PITCH			NOTE
	MIN. NOM. MAX.			
⌀	0.50 BSC.			
N		32		3
ND		8		3
NE		8		3
L	0.35	0.41	0.46	
b	0.21	0.25	0.29	
D2	3.76	3.82	3.88	
E2	3.76	3.82	3.88	

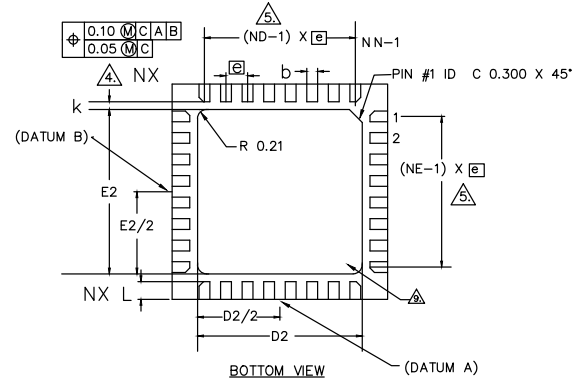
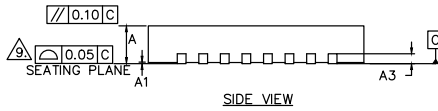
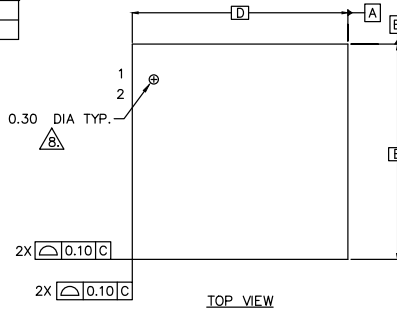

Pin	Input/Output
1,2,3	NC
4	RF IN
5	RF IN
6,7,8,9	NC
10	VG1
11	NC
12	VG2
13,14,15,16	NC
17,18,19	NC
20	RF OUT
21	RF OUT
22,23,24	NC
25	VD2
26,27,28,29	NC
30,31	NC
32	VD1

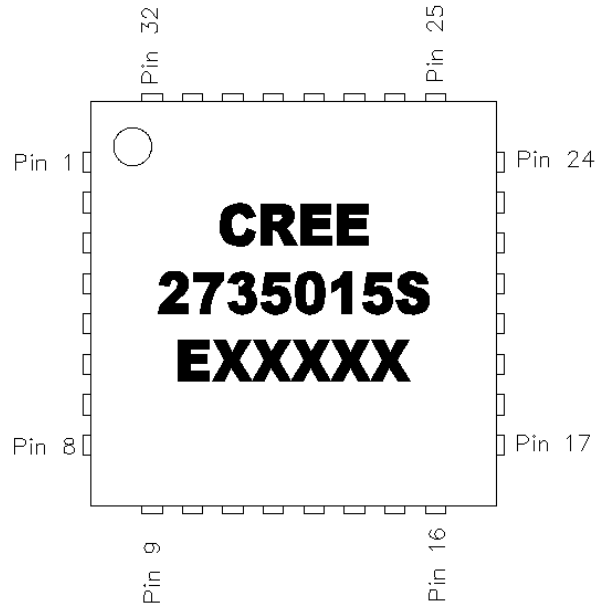



Part Number System

CPMA2735015S

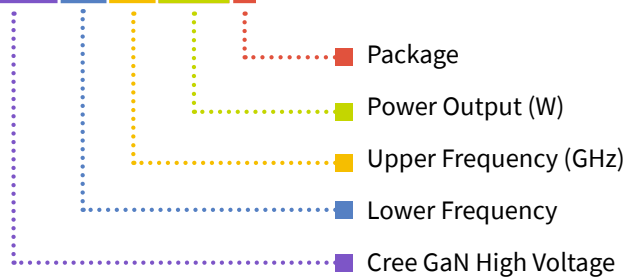

Table 1.



Parameter	Value	Units
Lower Frequency	2.7	GHz
Upper Frequency	3.5	GHz
Power Output	15	W
Package	Surface Mount	-

Note¹: Alpha characters used in frequency code indicate a value greater than 9.9 GHz. See Table 2 for value.

Table 2.

Character Code	Code Value
A	0
B	1
C	2
D	3
E	4
F	5
G	6
H	7
J	8
K	9
Examples:	1A = 10.0 GHz 2H = 27.0 GHz

Product Ordering Information

Order Number	Description	Unit of Measure	Image
CMPA2735015S	GaN HEMT	Each	
CMPA2735015S-AMP1	Test board with GaN MMIC installed	Each	



For more information, please contact:

4600 Silicon Drive
Durham, North Carolina, USA 27703
www.wolfspeed.com/RF

Sales Contact
RFSales@wolfspeed.com

RF Product Marketing Contact
RFMarketing@wolfspeed.com
919.407.7816

Notes

Disclaimer

Specifications are subject to change without notice. “Typical” parameters are the average values expected by Cree in large quantities and are provided for information purposes only. Cree products are not warranted or authorized for use as critical components in medical, life-saving, or life-sustaining applications, or other applications where a failure would reasonably be expected to cause severe personal injury or death. No responsibility is assumed by Cree for any infringement of patents or other rights of third parties which may result from use of the information contained herein. No license is granted by implication or otherwise under any patent or patent rights of Cree.