

Specifications:

Current Rating:9.0A AC/DC

Voltage Rating:600V AC/DC

Contact Resistance:10m Ohm. Max.

Insulation Resistance:1000M Ohm. Min.

Withstanding Voltage:1500V AC/Minute

Operating Temperature Range:-40°C To +105°C

Material:

Insulator:Nylon 66 (UL94V-0)

Insulator Color:White

Dimension:

Pos	Dim.A	Dim.B	Pos	Dim.A	Dim.B
02	—	5.4	14	25.2	30.6
04	4.2	9.6	16	29.4	34.8
06	8.4	13.8	18	33.6	39.0
08	12.6	18.0	20	37.8	43.2
10	16.8	22.2	22	42.0	47.4
12	21.0	26.4	24	46.2	51.6

RoHS Compliant

REV	DATE	FILE	BY

DRAWN:  
CHECKED:  
APPROVAL:

GENERAL TOLERANCE:  
.X=±0.40  
.XX=±0.30  
UNIT: MM  
SCALE:1:1  
SHEET: 1 / 3  
PROJECTION:

**CnC Tech**  
Industrial Cable and Connector Technology  
DESCRIPTION:  
**CONN PLUG DUAL 94V-0**  
PART NO:  
**4282-3-XX-D**

SIZE  
**A4**

1

2

3

4

5

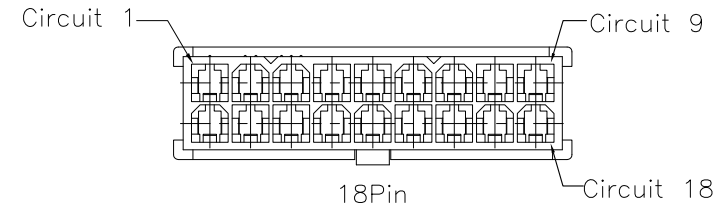
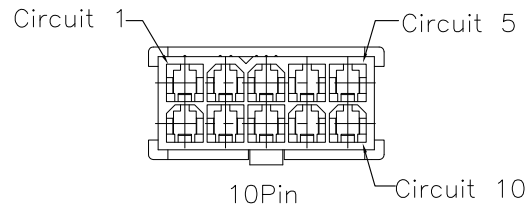
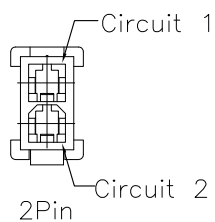
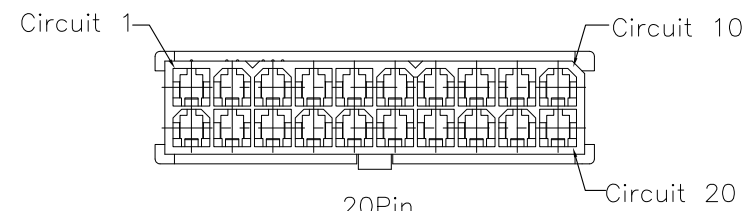
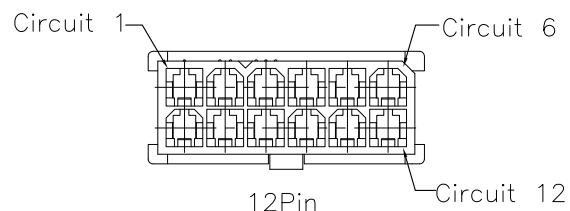
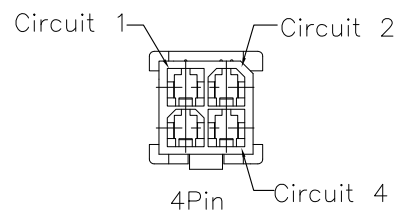
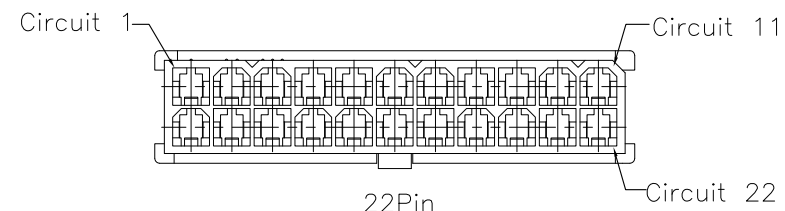
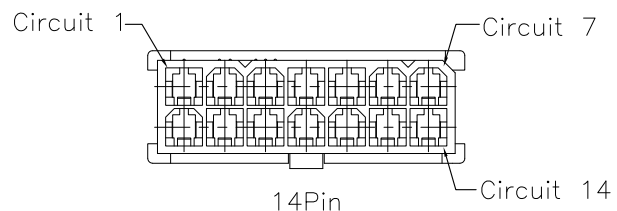
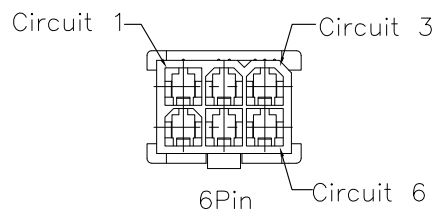
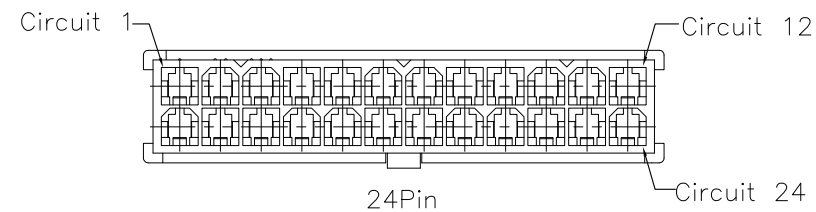
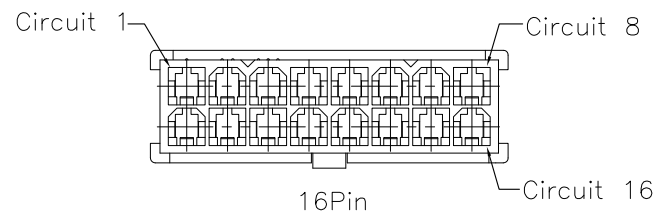
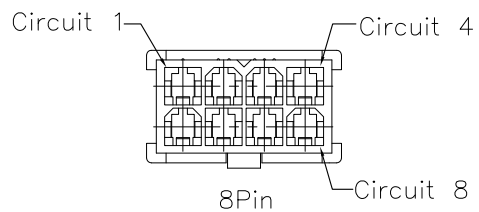

2~24P Protection Key Drawing(Ref.)

RoHS Compliant

				DRAWN:	GENERAL TOLERANCE: .X=±0.40 .XX=±0.30	<h1 style="color: red; text-align: center;">CnC Tech</h1> <p style="text-align: center;">Industrial Cable and Connector Technology</p>	
				CHECKED:	UNIT: MM		
				APPROVAL:	SCALE:1:1	PART NO: 4282-3-XX-D	A4
REV	DATE	FILE	BY		SHEET: 2 / 3		
					PROJECTION:		

A

B

C

D

1

2

3

4

5

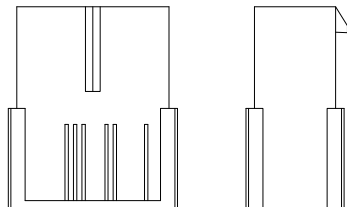
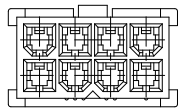

Note:

1.Dimension:

Pe Bag Size:XX\*XX (mm)

Carton Size:400\*280\*280(mm)

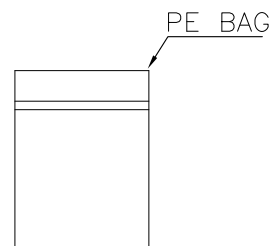

Pin.	Pcs/Bag	Pcs/Carton	Pin.	Pcs/Bag	Pcs/Carton
2	200	5600	14	100	1600
4	200	4600	16	100	1200
6	100	3000	18	100	1000
8	100	2400	20	100	1000
10	100	2000	22	50	800
12	100	1800	24	50	800

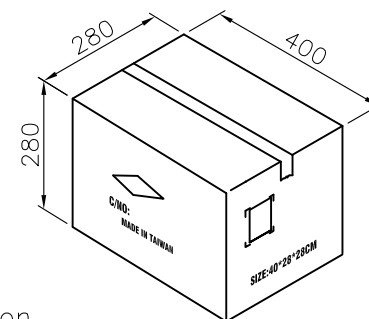
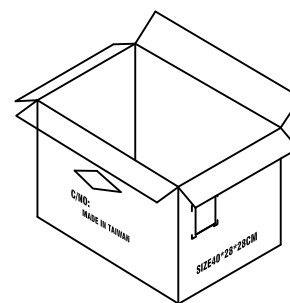

Carton

				DRAWN:	GENERAL TOLERANCE: .X=±0.2 .XX=±0.15	<b>CnC Tech</b> Industrial Cable and Connector Technology	SIZE
				CHECKED:	UNIT: MM		
				APPROVAL:	SCALE:	PART NO: <b>4282-3-XX-D</b>	<b>A4</b>
REV	DATE	FILE	BY		PROJECTION:		