

Red Top-View Surface Mount LED with Domed Lens

OVSASBLCR8

- High intensity with low power consumption
- White PLCC4 package with clear domed lens
- Wide viewing angle
- Packaged in 8 mm tape on 7" diameter reel
- Compatible with automatic placement equipment
- Compatible with infrared and vapor phase reflow solder process
- Red (628 nm)

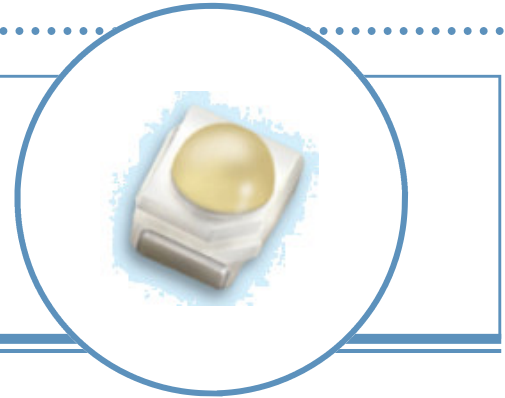

The **OVSASBLCR8** is designed for focused, uniform light output. Its internal reflector and colorless clear lens optimize luminous intensity and make it ideal for backlighting applications and for coupling with light guides.

Applications

- Traffic lights
- Signal and symbol luminaire
- Mono-color indicators
- Backlighting (LCD, switches, displays, illuminated advertising)
- Interior automotive lighting (instrumentation clusters)
- Safety marker lights (steps, exit ways)

Part Number	Material	Emitted Color	Intensity Typ. mcd	Luminous Flux Typ. mlm	Lens Color
OVSASBLCR8	AlInGaP	Red	2200	2550	Water Clear

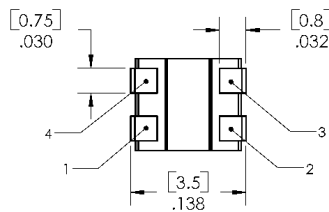
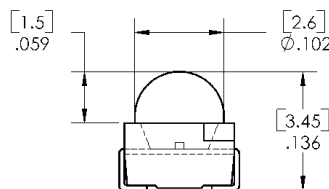
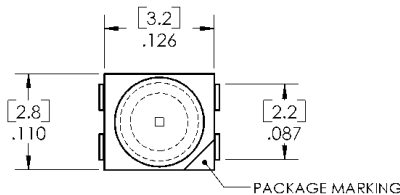

1, 2, 3 CATHODE 4 ANODE
 DIMENSIONS ARE IN: [MILLIMETERS]
 INCHES



DO NOT LOOK DIRECTLY AT RED LED WITH UNSHIELDED EYES OR DAMAGE TO RETINA MAY OCCUR.

OPTEK reserves the right to make changes at any time in order to improve design and to supply the best product possible.

Red Top-View SMD LED with Domed Lens

OVSASBLCR8



Absolute Maximum Ratings

$T_A = 25^\circ\text{C}$ unless otherwise noted

Storage Temperature Range	-40 ~ +100°C
Operating Temperature Range	-40 ~ +100°C
Junction Temperature	110°C
Reverse Voltage	5 V
Continuous Forward Current	70 mA
Peak Forward Current (10% Duty Cycle, PW ≤ 100 μsec)	200 mA
Power Dissipation	225 mW

Electrical Characteristics

$T_A = 25^\circ\text{C}$ unless otherwise noted

SYMBOL	PARAMETER	MIN	TYP	MAX	UNITS	CONDITIONS
I_V	Luminous Intensity	1400	2200	3550	mcd	$I_F = 50\text{ mA}$
Φ_V	Luminous Flux	----	2550	----	mlm	$I_F = 50\text{ mA}$
V_F	Forward Voltage	----	2.5	3.2	V	$I_F = 50\text{ mA}$
I_R	Reverse Current	----	----	10	μA	$V_R = 5\text{ V}$
λ_D	Dominant Wavelength	620	628	635	nm	$I_F = 50\text{ mA}$
$2\ \Theta_{1/2}$	50% Power Angle	----	60	----	deg	$I_F = 50\text{ mA}$

Standard Bins ($I_F = 50\text{ mA}$)

Lamps are sorted to luminous intensity (I_V) and dominant wavelength (λ_D) bins shown. Orders for OVSASBLCR8 may be filled with any or all bins contained as below.

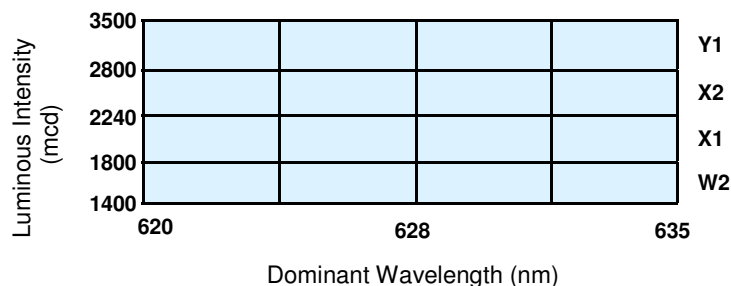

Notes:

- All ranks will be included per delivery. Rank ratio will be based on the chip distribution.
- To designate luminous intensity ranks, please contact OPTEK.

OPTEK reserves the right to make changes at any time in order to improve design and to supply the best product possible.

Typical Electro-Optical Characteristics Curves

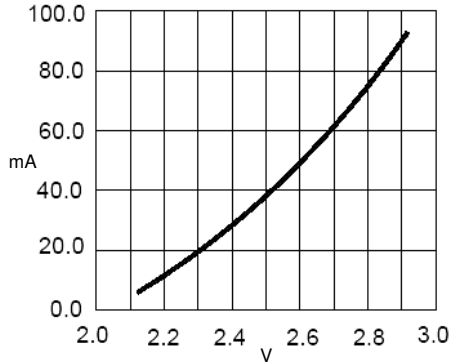

Forward Current vs Forward Voltage

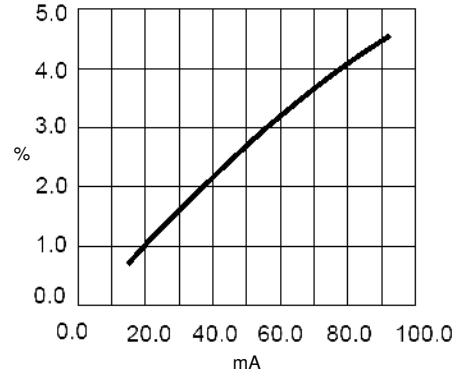

Relative Luminous Intensity vs Forward Current

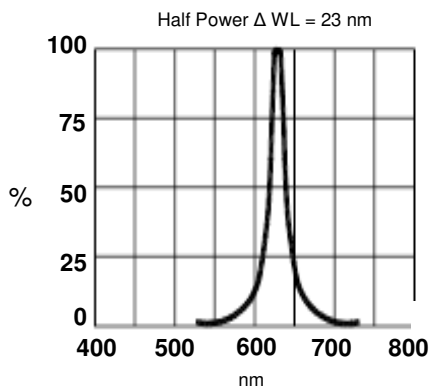

Relative Luminous Intensity vs Wavelength

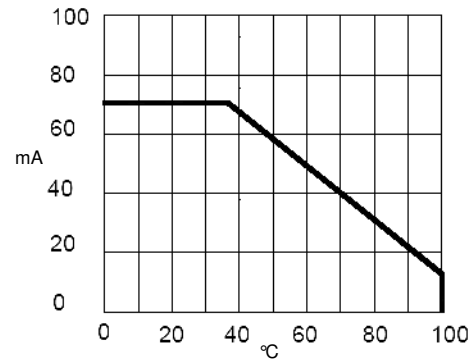

Maximum Forward DC Current vs Ambient Temperature

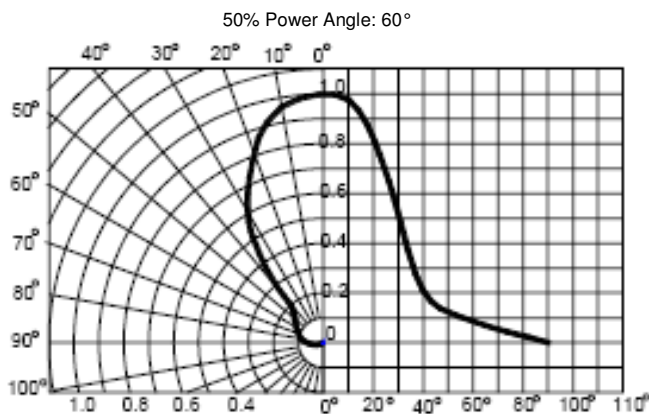

Spatial Distribution

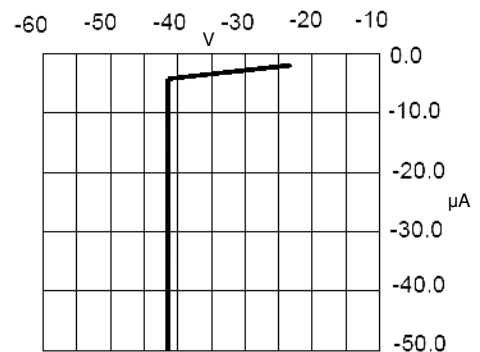

Reverse Current vs Reverse Voltage

OPTEK reserves the right to make changes at any time in order to improve design and to supply the best product possible.

Red Top-View SMD LED with Domed Lens OVSASBLCR8



Reel Dimensions: 7-inch reel

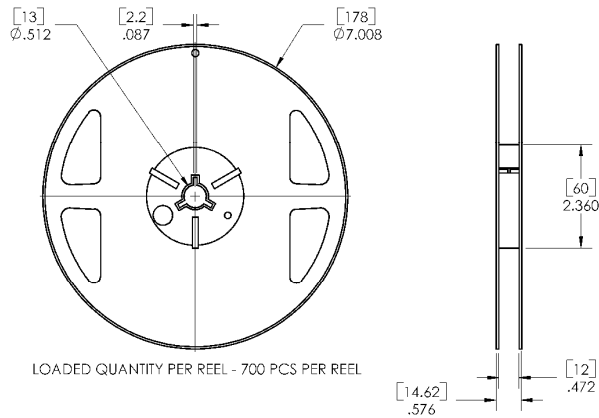

Carrier Tape Dimensions: Loaded quantity 700 pieces per reel

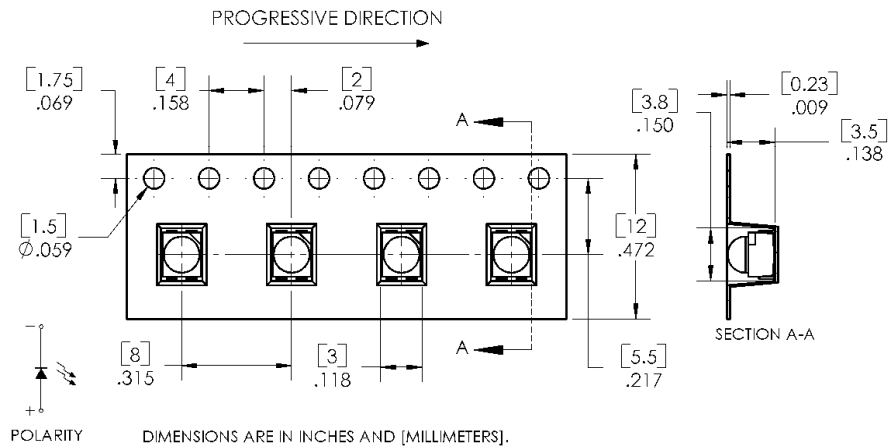

Moisture Resistant Packaging

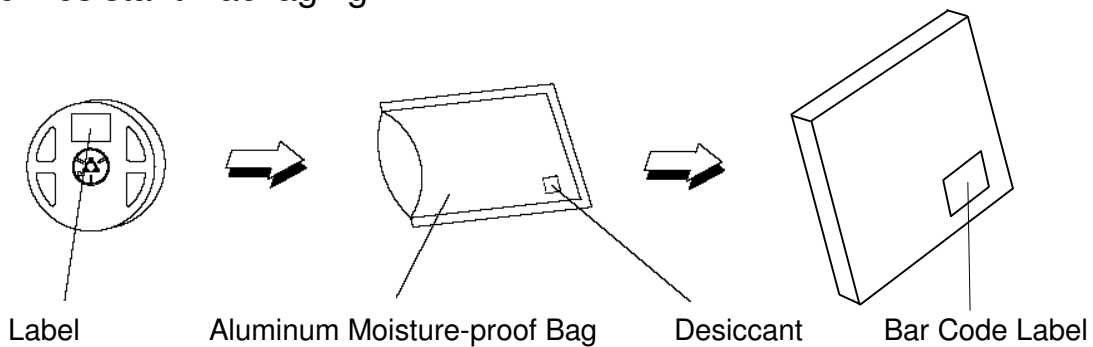

OPTEK reserves the right to make changes at any time in order to improve design and to supply the best product possible.

