

# 2SK1949 (L), 2SK1949 (S)

Silicon N Channel MOS FET

## Application

High speed power switching

## Features

- Low on-resistance
- High speed switching
- Low drive current
- 4 V gate drive device can be driven from 5 V source
- Suitable for Switching regulator, DC – DC converter
- Avalanche ratings

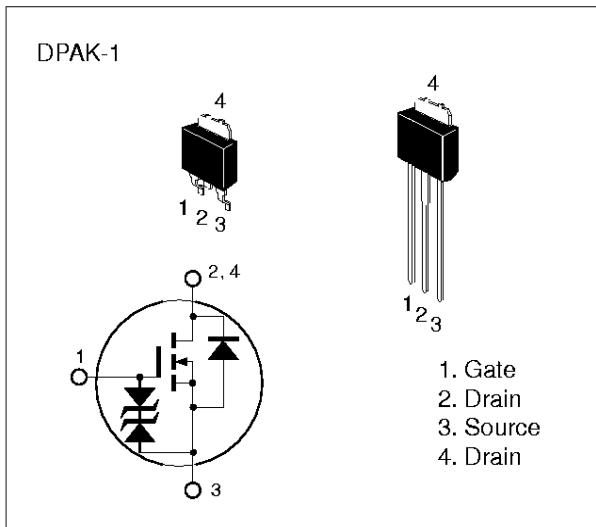

**Table 1 Absolute Maximum Ratings** ( $T_a = 25^\circ\text{C}$ )

Item	Symbol	Ratings	Unit
Drain to source voltage	$V_{DSS}$	60	V
Gate to source voltage	$V_{GSS}$	$\pm 20$	V
Drain current	$I_D$	5	A
Drain peak current	$I_{D(pulse)}^*$	20	A
Body-drain diode reverse drain current	$I_{DR}$	5	A
Avalanche current	$I_{AP}^{***}$	5	A
Avalanche energy	$E_{AR}^{***}$	2.1	mJ
Channel dissipation	$P_{ch}^{**}$	20	W
Channel temperature	$T_{ch}$	150	$^\circ\text{C}$
Storage temperature	$T_{stg}$	-55 to +150	$^\circ\text{C}$

\*  $PW \leq 10 \mu\text{s}$ , duty cycle  $\leq 1\%$

\*\* Value at  $T_c = 25^\circ\text{C}$

\*\*\* Value at  $T_{ch} = 25^\circ\text{C}$ ,  $R_g \geq 50 \Omega$

**Table 2 Electrical Characteristics** ( $T_a = 25^\circ\text{C}$ )

Item	Symbol	Min	Typ	Max	Unit	Test conditions
Drain to source breakdown voltage	$V_{(BR)DSS}$	60	—	—	V	$I_D = 10 \text{ mA}$ , $V_{GS} = 0$
Gate to source breakdown voltage	$V_{(BR)GSS}$	$\pm 20$	—	—	V	$I_G = \pm 100 \mu\text{A}$ , $V_{DS} = 0$
Gate to source leak current	$I_{GSS}$	—	—	$\pm 10$	$\mu\text{A}$	$V_{GS} = \pm 16 \text{ V}$ , $V_{DS} = 0$
Zero gate voltage drain current	$I_{DSS}$	—	—	100	$\mu\text{A}$	$V_{DS} = 50 \text{ V}$ , $V_{GS} = 0$
Gate to source cutoff voltage	$V_{GS(off)}$	1.0	—	2.25	V	$I_D = 1 \text{ mA}$ , $V_{DS} = 10 \text{ V}$
Static drain to source on state resistance	$R_{DS(on)}$	—	0.12	0.15	$\Omega$	$I_D = 3 \text{ A}$ $V_{GS} = 10 \text{ V}^*$
		—	0.15	0.2	$\Omega$	$I_D = 3 \text{ A}$ $V_{GS} = 4 \text{ V}^*$
Forward transfer admittance	$ y_{fs} $	3	5.5	—	S	$I_D = 3 \text{ A}$ $V_{DS} = 10 \text{ V}^*$
Input capacitance	$C_{iss}$	—	390	—	pF	$V_{DS} = 10 \text{ V}$
Output capacitance	$C_{oss}$	—	190	—	pF	$V_{GS} = 0$
Reverse transfer capacitance	$C_{rss}$	—	45	—	pF	$f = 1 \text{ MHz}$
Turn-on delay time	$t_{d(on)}$	—	10	—	ns	$I_D = 3 \text{ A}$
Rise time	$t_r$	—	42	—	ns	$V_{GS} = 10 \text{ V}$
Turn-off delay time	$t_{d(off)}$	—	90	—	ns	$R_L = 10 \Omega$
Fall time	$t_f$	—	55	—	ns	
Body-drain diode forward voltage	$V_{DF}$	—	1.0	—	V	$I_F = 5 \text{ A}$ , $V_{GS} = 0$
Body-drain diode reverse recovery time	$t_{rr}$	—	60	—	ns	$I_F = 5 \text{ A}$ , $V_{GS} = 0$ , $di_F / dt = 50 \text{ A} / \mu\text{s}$

\* Pulse Test

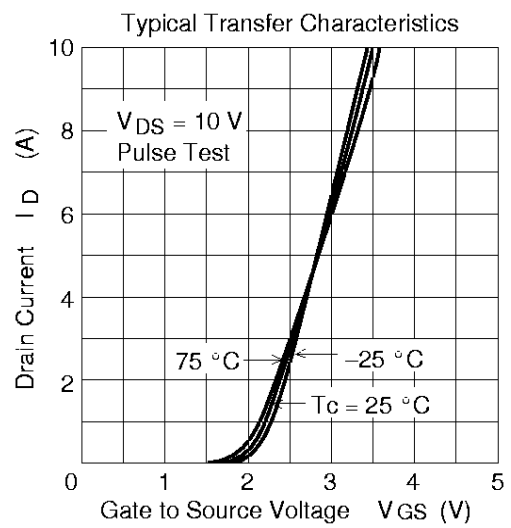
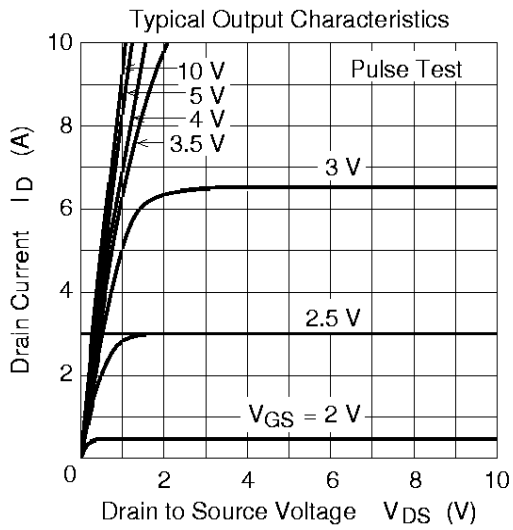
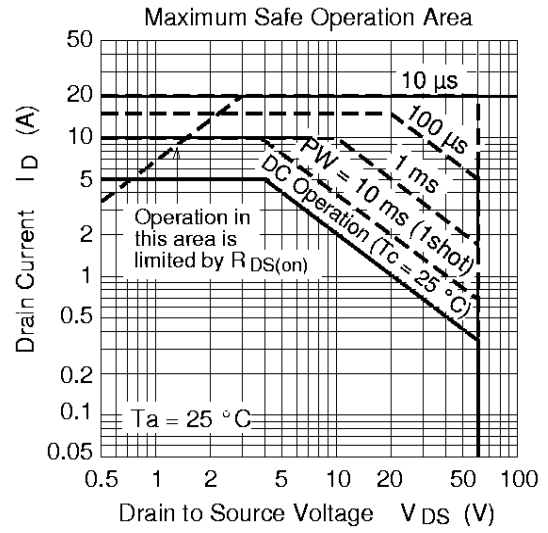
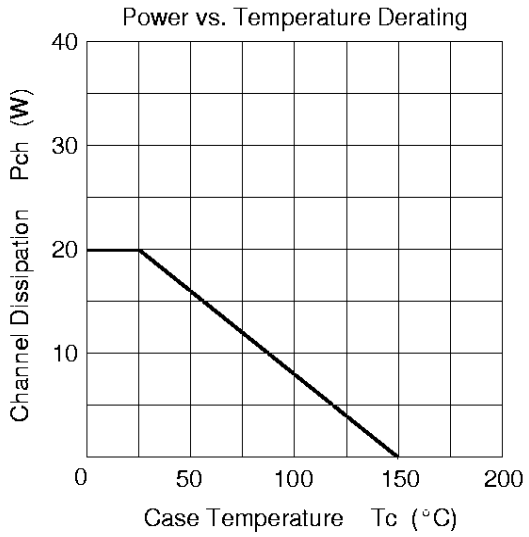

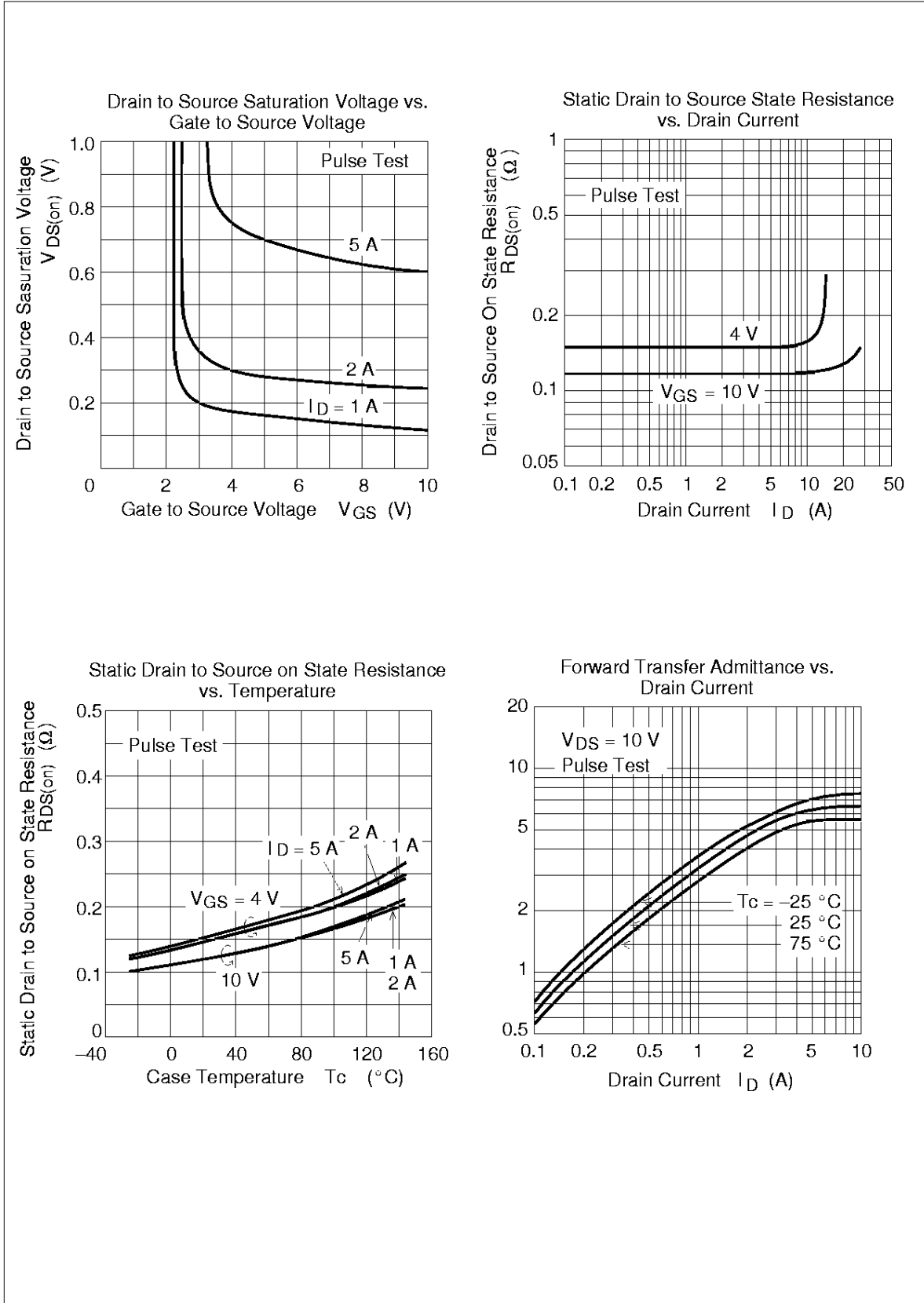

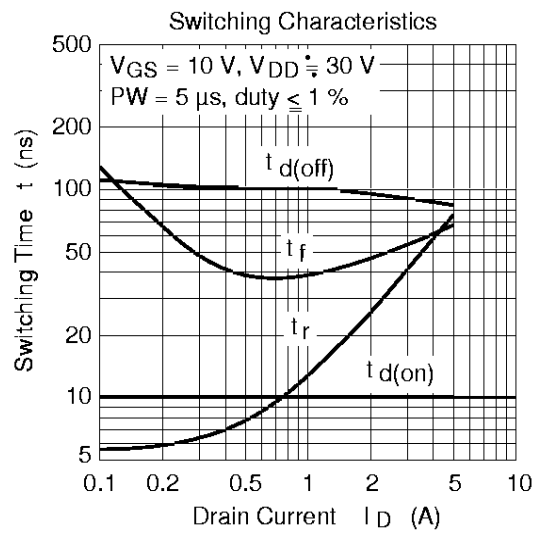
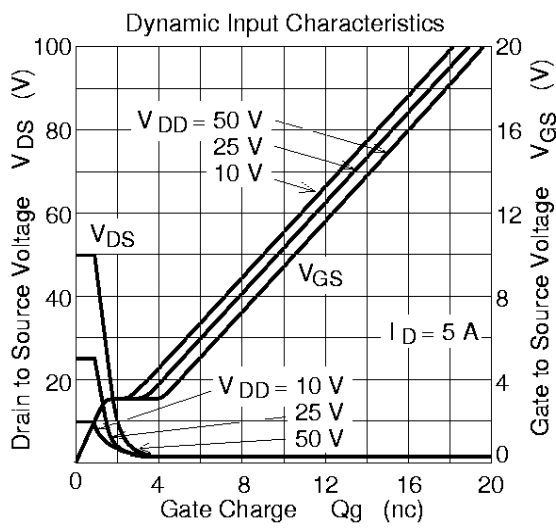
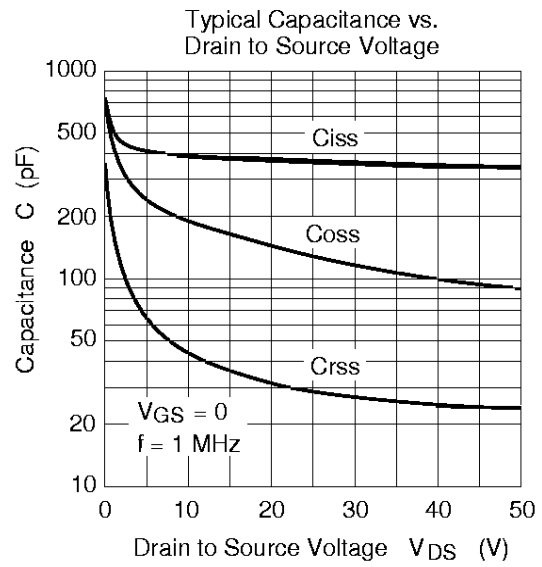
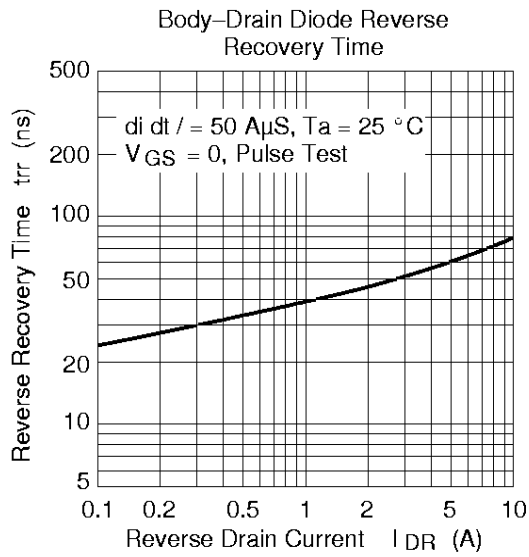

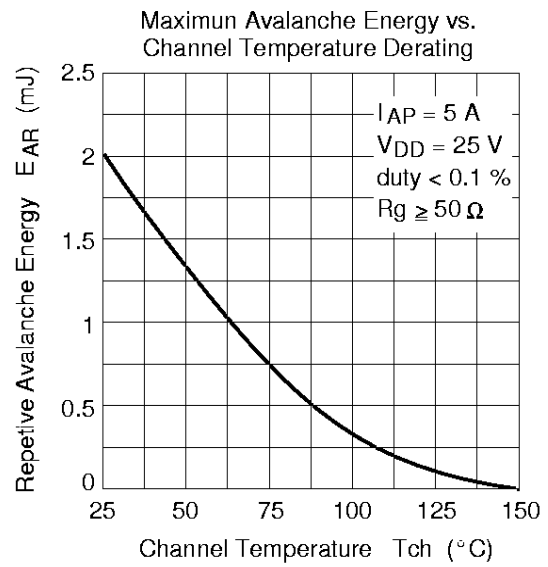
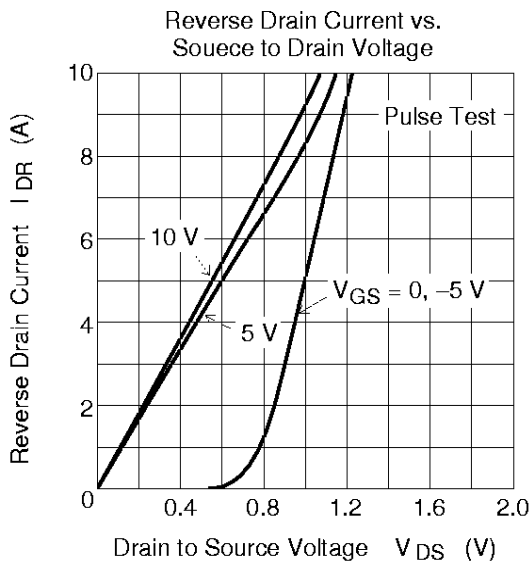

Avalanche Test Circuit and Waveform

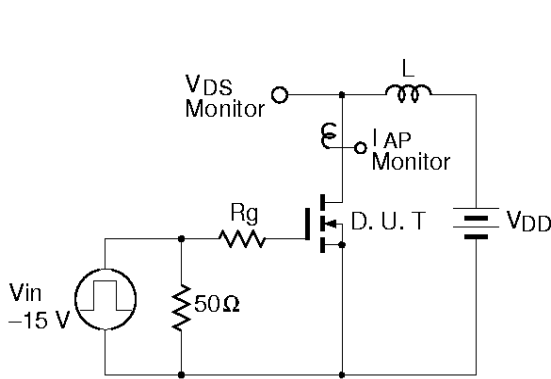

$$E_{AR} = \frac{1}{2} \cdot L \cdot I_{AP}^2 \cdot \frac{V_{DSS}}{V_{DSS} - V_{DD}}$$

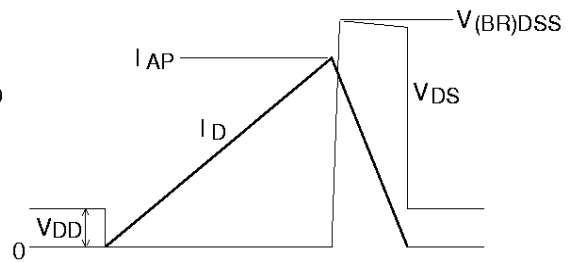

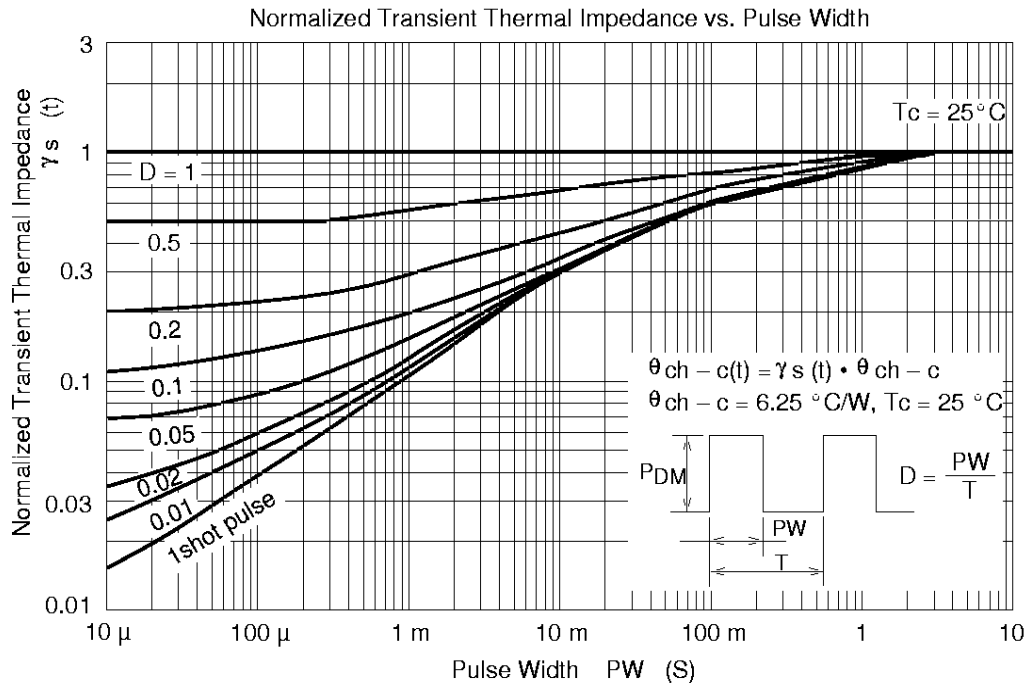

Switching Time Test Circuit

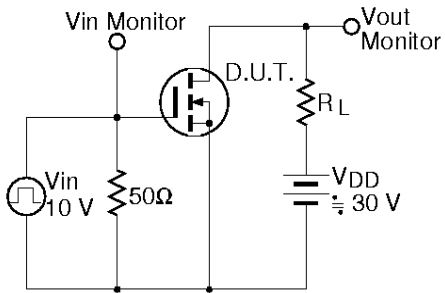

Waveform

