

## Switching Regulator Series

# Buck Converter with Integrated FET BD9E104FJ EVK

**BD9E104FJ-EVK-001 (12V→5V, 1.0A)**

### Introduction

This user's guide provide the necessary steps to operate the EVK of ROHM's BD9E104FJ 1channel Buck DC/DC converter. This include the external parts, operating procedures and application data.

### Description

This EVK has been developed for ROHM's synchronous buck DC/DC converter customers evaluating BD9E104FJ and outputs 5V from 12V input voltage. The BD9E104FJ accepts a power supply input range of 7V to 26V, and generates output voltage ranging from 1.0V to  $0.5 \times V_{IN}$  using external resistors. The operating frequency is fixed at 570 kHz. The SLLM™ (Simple Light Load Mode) control provides good efficiency characteristics in light load conditions, which is ideal for equipment that want to reduce standby power. The current mode control DC/DC converter provides high-speed transient response performance. Additional protection functions include a built-in soft start function to prevent rush current at startup, UVLO (under voltage lock out), TSD (thermal shutdown detection), SCP(short current protection) and OCP (over current protection).

### Application

- DC/DC power supply for consumer electronics such as home appliances
- Secondary power supply and adapter equipment
- Communication equipment

### Operating Limits

Parameter	Min	Typ	Max	Units	Conditions
Input Voltage	10.0	12.0	18.0	V	
Output Voltage		5.0		V	
Output Current Range			1.0	A	
Operating Frequency		570		kHz	
Maximum Efficiency		92		%	
UVLO Detect Voltage		6.4		V	VCC sweep down
UVLO Hysteresis Width		200		mV	

## EVK

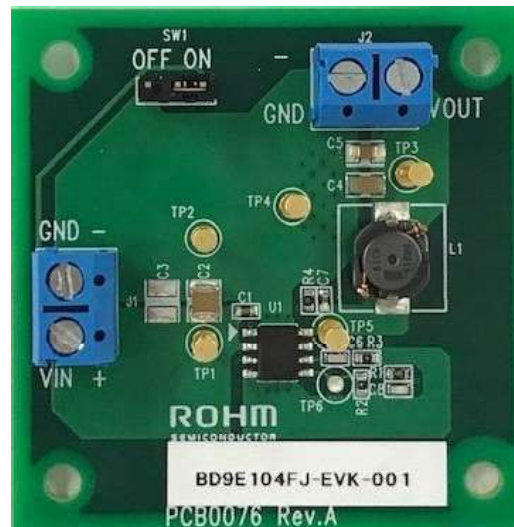

Figure 1. BD9E104FJ-EVK-001(Top View)

## EVK Schematic

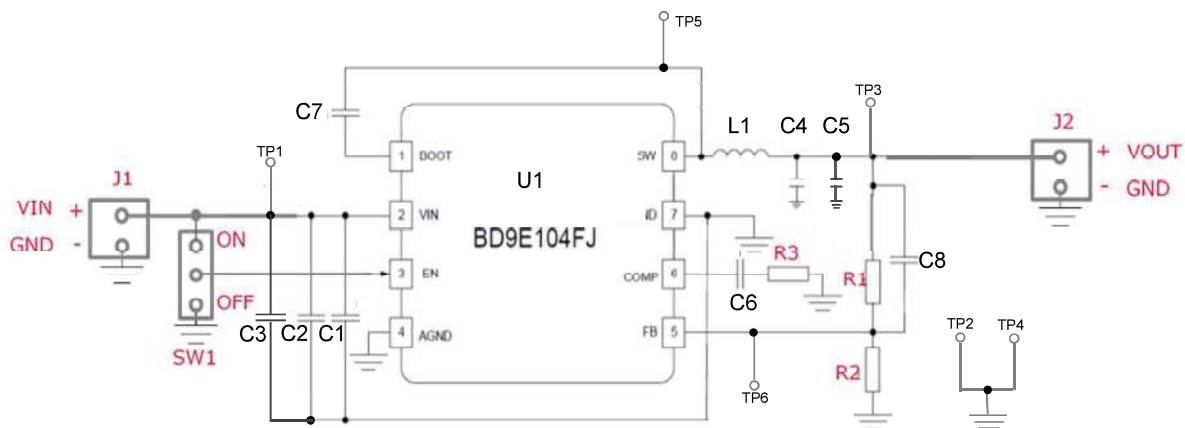

Figure 2. BD9E104FJ-EVK-001 Circuit Diagram

## Operating Procedure

1. Turn off the DC power supply and connect the GND terminal of the power supply to the GND terminal (J1) of the EVK.
2. Connect the VCC pin of the DC power supply to the VIN pin (J1) of the EVK.
3. Connect the load to the VOUT and GND terminals of J2 of EVK. When using an electronic load, connect with the load turned off.
4. Connect a voltmeter with the VOUT terminal to the EVK's TP3 and the GND terminal to the EVK's TP4.
5. Connect the jumper of SW1 to ON side.
6. Turn on the DC power supply. Make sure the voltmeter shows 5V.
7. Turn on the electronic load.

(Caution) This EVK does not support hot plug. Do not perform hot plug test.

## Operation State Settings

Below is a table of BD9E104FJ condition selectable using SW1.

Table 1. SW1 Settings

SW1 state	BD9E104FJ Condition
ON (short to VIN)	Enable
OFF (short to GND)	Shutdown

## Parts list

Table 2. Parts list

Count	Parts No.	Type	Value	Description	Manufacturer Part Number	Manufacturer	Size[Unit: mm(inch)]
<b>IC</b>							
1	U1	DCDC	-	Buck Converter	BD9E104FJ	ROHM	4.90 x 6.00
<b>Inductor</b>							
1	L1	Inductor	6.8μH	±30%, DCR=22mΩtyp, 4.1A	CLF7045NIT-6R8N	TDK	7.4 x 7.0
<b>Capacitor</b>							
2	C1,C7	MLCC	0.1μF	50V, X5R	GRM155 Series	MURATA	1005(0402)
1	C2	MLCC	10μF	50V, X5R	GRM32 Series	MURATA	3225(1210)
-	C3	-	-	No mounted	-	-	-
1	C4	MLCC	10μF	16V, X5R	GRM31 Series	MURATA	3216(1206)
1	C5	MLCC	22μF	10V, X5R	GRM21 Series	MURATA	2012(0805)
1	C6	MLCC	390pF	50V, ±10%	GRM188 Series	MURATA	1608(0603)
1	C8	MLCC	12pF	16V, ±10%	C0G(NP0) Series	AVX	1608(0603)
<b>Resistor</b>							
1	R1	Resistor	430kΩ	1/10W, ±1%	MCR03 Series	ROHM	1608(0603)
2	R2,R3	Resistor	82kΩ	1/10W, ±1%	KTR03 Series	ROHM	1608(0603)
<b>Switching Terminal</b>							
1	SW1	Pin header	-	2.54mm × 3 contacts	61300311121	Würth Electronics	-
1	SW1	Jumper	-	Jumper pin for SW1	60900213421	Würth Electronics	-
<b>Connector</b>							
2	J1,J2	Terminal Block	-	2 contacts, 15A, 5mm	691102710002	Würth Electronics	-
<b>Contact pin</b>							
5	TP1-5	Test Pin	-	10A, 1mm hole	ST-2-2	Sunhayato	-

**Board Layout**

EVK PCB information

Number of Layers	Material	Board Size	Copper Thickness
4	FR-4	50mm x 50mm x 1.6mmt	1oz (35μm)

The layout of BD9E104FJ-EVK-001 is shown below.

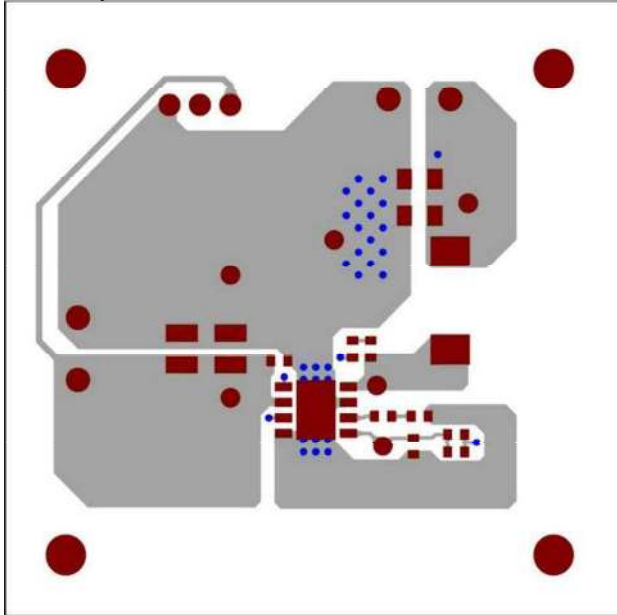

Figure 3. Top Layer Layout (Top View)

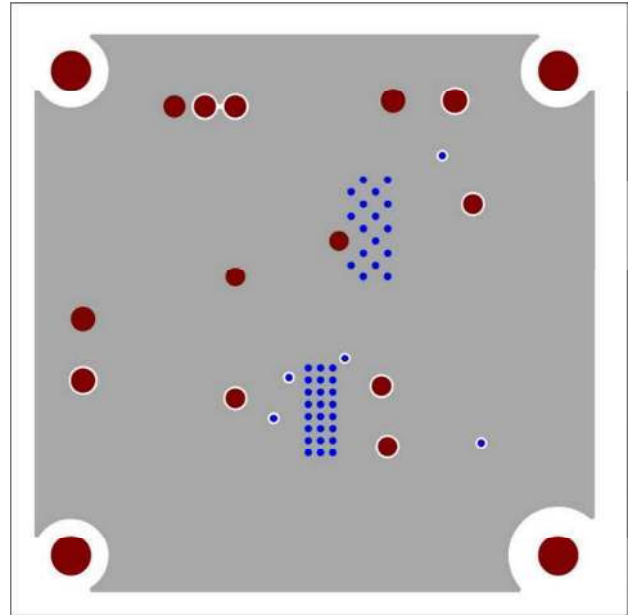

Figure 4. Middle1 Layer Layout (Top View)

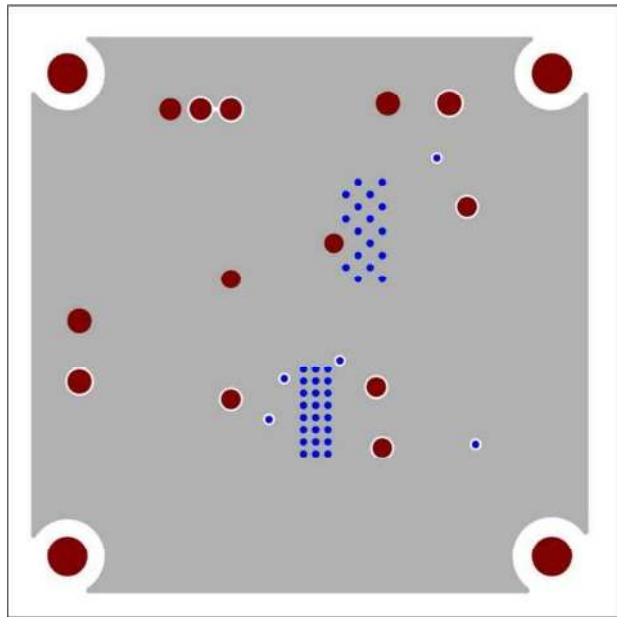

Figure 5. Middle2 Layer Layout (Top view)

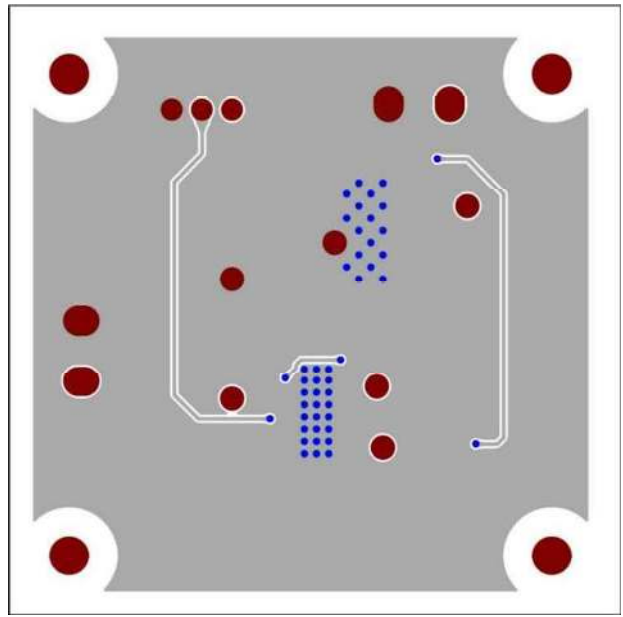

Figure 6. Bottom Layer Layout (Top view)

Reference application data

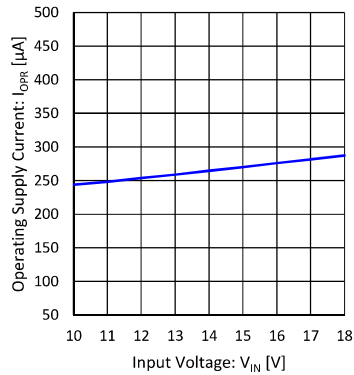

Figure 7. Operating quiescent current vs Input Voltage ( $V_{OUT}=5V$ ,  $I_{OUT}=0A$ )

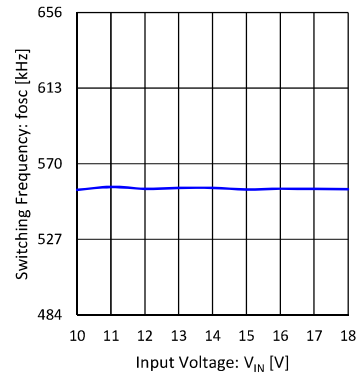

Figure 8. Switching frequency vs Input Voltage ( $V_{OUT}=5V$ ,  $I_{OUT}=1A$ )

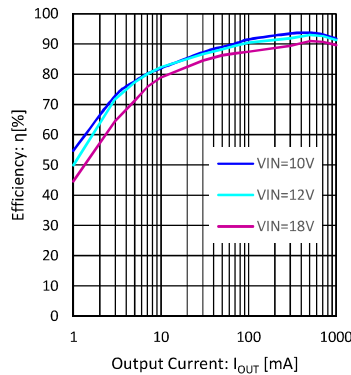

Figure 9. Efficiency vs Output current ( $V_{OUT}=5V$ )

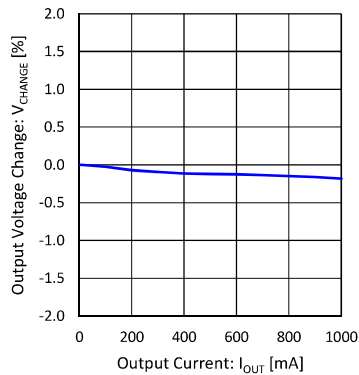

Figure 10.  $V_{OUT}$  Load regulation ( $V_{IN}=12V$ ,  $V_{OUT}=5V$ )

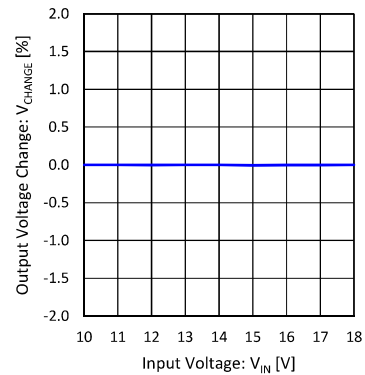

Figure 11.  $V_{OUT}$  Line regulation ( $V_{OUT}=5V$ ,  $I_{OUT}=1A$ )

Reference application data - continued

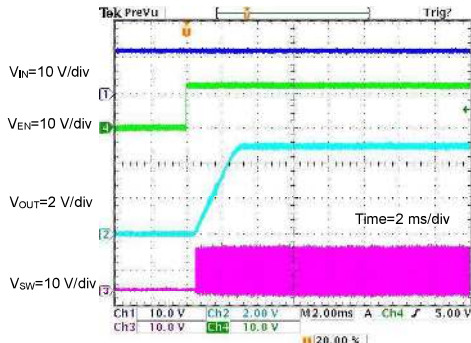

Figure 12. Rise-up waveform  
( $V_{EN}=0V \rightarrow 5V$ ,  $I_{OUT}=1A$ )

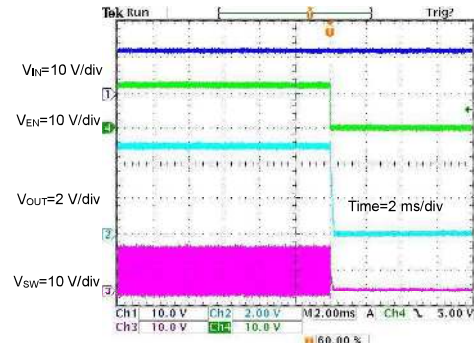

Figure 13. Shut-down waveform  
( $V_{EN}=5V \rightarrow 0V$ ,  $I_{OUT}=1A$ )

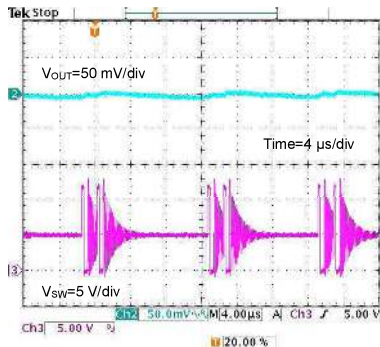

Figure 14. SW waveform  
( $V_{IN}=12V$ ,  $V_{OUT}=5V$ ,  $I_{OUT}=10mA$ )

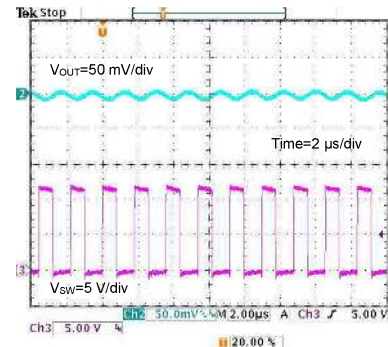

Figure 15. SW waveform  
( $V_{IN}=12V$ ,  $V_{OUT}=5V$ ,  $I_{OUT}=1A$ )

**Revision History**

<b>Date</b>	<b>Revision Number</b>	<b>Description</b>
17. Sep. 2020	001	Initial release

## Notes

- 1) The information contained herein is subject to change without notice.
- 2) Before you use our Products, please contact our sales representative and verify the latest specifications :
- 3) Although ROHM is continuously working to improve product reliability and quality, semiconductors can break down and malfunction due to various factors.  
Therefore, in order to prevent personal injury or fire arising from failure, please take safety measures such as complying with the derating characteristics, implementing redundant and fire prevention designs, and utilizing backups and fail-safe procedures. ROHM shall have no responsibility for any damages arising out of the use of our Products beyond the rating specified by ROHM.
- 4) Examples of application circuits, circuit constants and any other information contained herein are provided only to illustrate the standard usage and operations of the Products. The peripheral conditions must be taken into account when designing circuits for mass production.
- 5) The technical information specified herein is intended only to show the typical functions of and examples of application circuits for the Products. ROHM does not grant you, explicitly or implicitly, any license to use or exercise intellectual property or other rights held by ROHM or any other parties. ROHM shall have no responsibility whatsoever for any dispute arising out of the use of such technical information.
- 6) The Products specified in this document are not designed to be radiation tolerant.
- 7) For use of our Products in applications requiring a high degree of reliability (as exemplified below), please contact and consult with a ROHM representative : transportation equipment (i.e. cars, ships, trains), primary communication equipment, traffic lights, fire/crime prevention, safety equipment, medical systems, servers, solar cells, and power transmission systems.
- 8) Do not use our Products in applications requiring extremely high reliability, such as aerospace equipment, nuclear power control systems, and submarine repeaters.
- 9) ROHM shall have no responsibility for any damages or injury arising from non-compliance with the recommended usage conditions and specifications contained herein.
- 10) ROHM has used reasonable care to ensure the accuracy of the information contained in this document. However, ROHM does not warrants that such information is error-free, and ROHM shall have no responsibility for any damages arising from any inaccuracy or misprint of such information.
- 11) Please use the Products in accordance with any applicable environmental laws and regulations, such as the RoHS Directive. For more details, including RoHS compatibility, please contact a ROHM sales office. ROHM shall have no responsibility for any damages or losses resulting non-compliance with any applicable laws or regulations.
- 12) When providing our Products and technologies contained in this document to other countries, you must abide by the procedures and provisions stipulated in all applicable export laws and regulations, including without limitation the US Export Administration Regulations and the Foreign Exchange and Foreign Trade Act.
- 13) This document, in part or in whole, may not be reprinted or reproduced without prior consent of ROHM.



Thank you for your accessing to ROHM product informations.  
More detail product informations and catalogs are available, please contact us.

**ROHM Customer Support System**

<http://www.rohm.com/contact/>