

**NOTES:**

1. Material : Spring Steel
2. Finish : Glod Irridite
3. Ends : Closed and Ground
4. Total Coils : 10.000
5. Sugg. Max. Deflection : 0.130 (in)
6. Sugg. Max. Load : 2.300 (lbs)
7. All Drawing Dimensions are in Inches [mm]

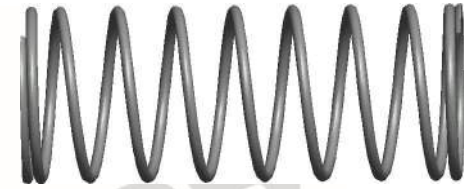

∅ 0.030  
[0,76]  
WIRE DIA



GROUND  
SURFACE

1.910  
[48,51]  
LENGTH

∅ 0.500  
[12,70]  
O.D

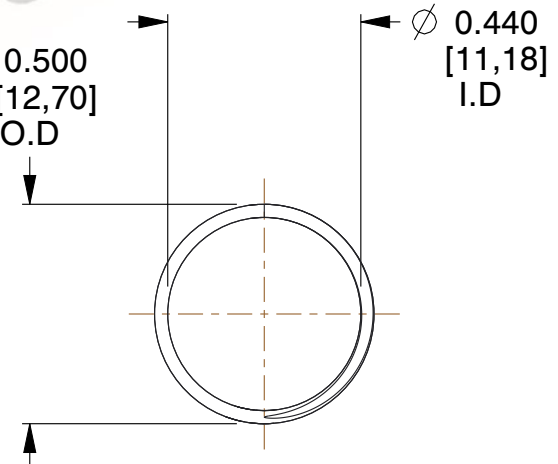

∅ 0.440  
[11,18]  
I.D

| COMPONENT           |  | SPRINGS   |  |
|---------------------|--|-----------|--|
| 11772               |  | UNIT      |  |
|                     |  | INCH [mm] |  |
|                     |  | SHEET     |  |
| COMPRESSION SPRINGS |  | 1 of 1    |  |