

TPS54201EVM-818 28-V, 1.5-A Buck LED Driver Evaluation Module

This user's guide describes the characteristics and use of the high-current buck light-emitting diode (LED) driver evaluation module.

Contents

1	Introduction	2
2	Warnings and Cautions	2
3	Description	2
	3.1 Typical Applications	3
	3.2 Test Setup	3
4	Performance Data and Typical Characteristics Curves	5
	4.1 Efficiency	5
	4.2 Line Regulation	6
	4.3 Load Regulation	6
	4.4 Analog Dimming	7
	4.5 PWM Dimming Waveforms	7
	4.6 LED Open and Short Protection	9
5	Schematic	10
6	TPS54201EVM-818 PCB Layout	11
7	Bill of Materials	13

List of Figures

1	Efficiency vs. PWM Duty in Analog Dimming Mode, 1.5 A at 100% Duty, $V_{IN} = 12\text{ V}$	5
2	Efficiency vs. Input Voltage in PWM Dimming Mode, 1 A at 100% Duty	5
3	LED Current Deviation vs. Input Voltage in Analog Dimming Mode, 1 WLED	6
4	LED Current Deviation vs. LED Numbers in Series in Analog Dimming Mode, $V_{IN} = 24\text{ V}$	6
5	Output Current Ratio vs. PWM duty cycle in Analog Dimming Mode	7
6	2% Duty Cycle 200-Hz PWM Dimming, Top = LED Current, Bottom = PWM	7
7	50% Duty Cycle 200-Hz PWM Dimming, Top = LED Current, Bottom = PWM	8
8	99% Duty Cycle 200-Hz PWM Dimming, Top = LED Current, Bottom = PWM	8
9	LED Open Failure Protection	9
10	LED Short Failure Protection	9
11	TPS54201EVM-818 Schematic	10
12	Top Layer and Top Overlay (Top View)	11
13	Bottom Layer and Bottom Overlay (Bottom View)	12

List of Tables

1	TPS54201EVM-818 Electrical Performance Specifications	3
2	EVM Connectors and Test Points	3
3	TPS54201EVM-818 Components List	13

Trademarks

All trademarks are the property of their respective owners.

1 Introduction

The TPS54201EVM-818 evaluation module (EVM) helps designers evaluate the operation and performance of the TPS54201 synchronous buck switching regulator designed for high-current LED driver applications. The TPS54201 is a 1.5-A synchronous buck LED driver and features a wide input voltage range (4.5 V to 28 V), deep analog mode dimming (1% to 100%) implemented by PWM input, and PWM mode dimming capability. It also has full protection, including LED open protection and short protection, sense resistor open protection and short protection, and thermal protection.

2 Warnings and Cautions

Observe the following precautions when using the TPS54201EVM-818.

WARNING



When choosing an LED component (not included with this EVM) the end-user must consult the LED data sheet supplied by the LED manufacturer to identify the EN62471 Risk Group Rating and review any potential eye hazards associated with the LED chosen. Always consider and implement the use of effective light filtering and darkening protective eyewear and be fully aware of surrounding laboratory-type set-ups when viewing intense light sources that may be required to minimize or eliminate such risks in order to avoid accidents related to temporary blindness.

3 Description

The TPS54201EVM-818 provides an LED driver based on the TPS54201 buck regulator. It is designed to operate with an input voltage in the range of 4.5 V to 28 V. The EVM is set up for a default output current of 1.5 A at 3.3 V / 100% duty cycle PWM input, which makes the driver work in analog dimming mode. If PWM dimming mode is chosen, the output current will be halved to 750 mA. See the TPS54201 data sheet ([SLUSCO8](#)) for more information about choosing dimming mode and components selection. The forward voltage of the LED load is between approximately 1.5 V and 23 V (depending on the input voltage). The TPS54201 helps provide high efficiency, wide dimming range, good line regulation, and low output ripple LED driver.

3.1 Typical Applications

This converter design describes an application of the TPS54201 as an LED driver using the following specifications. For applications with a different input voltage range or different output voltage and current, see the TPS54201 data sheet ([SLUSCO8](#)).

[Table 1](#) lists the electrical performance specifications.

Table 1. TPS54201EVM-818 Electrical Performance Specifications

Parameter	Test Conditions	MIN	TYP	MAX	Units
Input voltage range, V_{IN}		4.5		28	V
Output voltage range, V_{OUT}	LED+ to LED-, depends on V_{IN}	1.5		23	V
Output current	3.3V, 100% duty PWM input	1.44	1.5	1.56	A
Output current ripple	$V_{IN} = 28$ V, 6 White LEDs, 1.5-A output current		20		mApp
Analog dimming range	3.3-V PWM amplitude, 50 kHz	1		100	%
PWM dimming range	1.5-V PWM amplitude, 200 Hz, $V_{IN} = 24$ V, 3 White LEDs, 1.5-A output current	2		100	%
Efficiency	$V_{IN} = 21$ V, 5 White LEDs, 1-A output current, PWM dimming mode		96		%
Switching frequency			600		kHz

3.2 Test Setup

This section describes the connectors and test points on the EVM and how to properly connect, setup, and use the TPS54201EVM-818.

3.2.1 Connector Description

Table 2. EVM Connectors and Test Points

Reference Designator	Function
J1	V_{IN} (see Table 1 for V_{IN} range)
J2	LED load, make sure the LED has a maximum 1.5-A current rating
J3/J4	2-pin header to enable driver when no dimming required
TP1	BOOT test point
TP2	SW test point
TP3	V_{IN} test point
TP4	VOUT test point, also the anode of the LED load
TP5	FB test point
TP6	LOOP test point between FB filter and VSENSE. Used for loop response measurements.
TP7	VSENSE test point, also the cathode of the LED load
TP8	PWM input here
TP9	PWM test point
TP10	GND terminal for PWM input
TP11	GND test point at VIN
TP12/TP13/T P14	General purpose GND test point

3.2.2 Input/Output Connection

A power supply capable of supplying 2 A must be connected to J1 through a pair of 20-AWG wires. The LED load must be connected to J2 through a pair of 20-AWG wires. The positive terminal of the LED load should be connected to the J2 terminal beside TP4 (VOUT), and the negative terminal of the LED load should be connected to the J2 terminal beside TP7 (VSENSE). Wires should be twisted and kept as short as possible to minimize voltage drop, inductance, and EMI transmission.

TP8/TP10 are the input terminals for the PWM dimming signal. If analog dimming mode is used, apply a square wave with a low level of GND and a high level higher than 2 V, typically 3.3 V. The PWM frequency range is 10 kHz to 100 kHz, typically 50 kHz. If PWM dimming mode is used, apply a square wave with a low level of GND and a high level voltage between 1 V and 2 V, typically 1.5 V. The dimming frequency range is 100 Hz to 1 kHz.

Once the connection is ready, first apply the input voltage, then apply the PWM signal.

3.2.3 No Dimming Application

In a case where no dimming function is needed, J3 and J4 can be shorted to feed the input voltage to the PWM pin through resistor divider R5 and R8, thus no external PWM signal is needed. The value of the resistor divider is sized to make a converter work in PWM dimming mode with 100% duty under 24-V nominal input voltage. See the data sheet to change the resistor divider if a different input voltage is needed.

4 Performance Data and Typical Characteristics Curves

The figures in this section present the typical performance of the TPS54201EVM-818. The ambient temperature is 25°C, unless otherwise noted.

4.1 Efficiency

Figure 1 shows the efficiency versus PWM duty in analog dimming mode. The maximum LED current is 1.5 A when the PWM duty is 100%. $V_{IN} = 12\text{ V}$, and an infrared (IR) LED load is used. The typical forward voltage of an IR LED is 1.8 V at 1.5 A. The LED number in series is 1, 3, and 5, respectively.

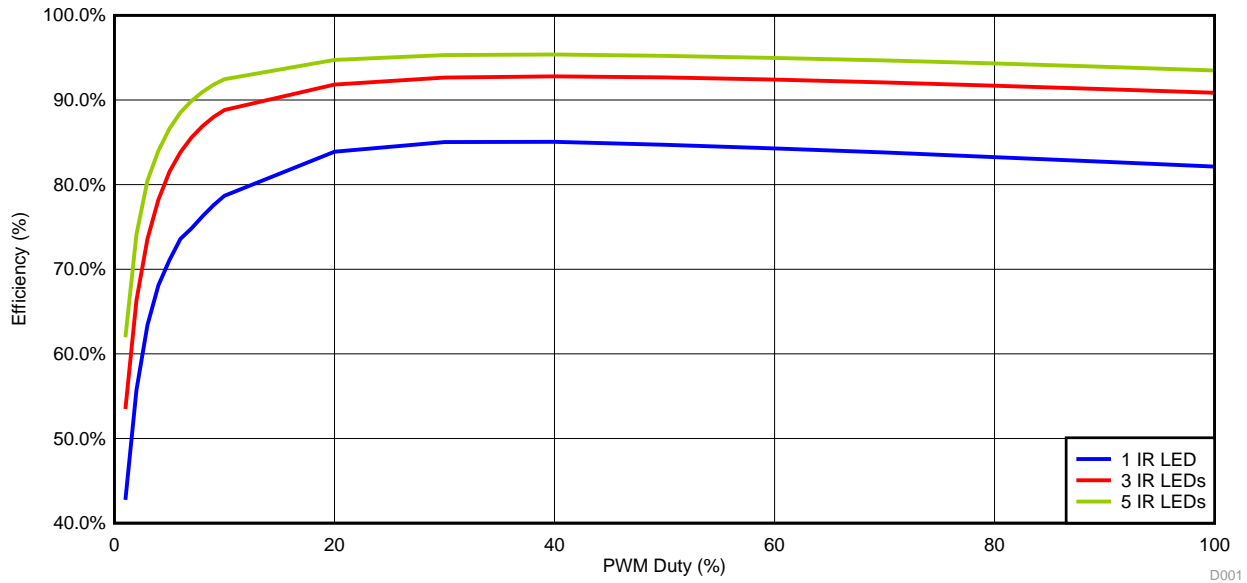

Figure 1. Efficiency vs. PWM Duty in Analog Dimming Mode, 1.5 A at 100% Duty, $V_{IN} = 12\text{ V}$

Figure 2 shows the efficiency versus input voltage in PWM dimming mode. PWM duty is 100%, LED current is set at 1 A. A White LED load is used. The typical forward voltage of a White LED is 3 V at 1 A. The LED number in series is 1, 3, and 5, respectively.

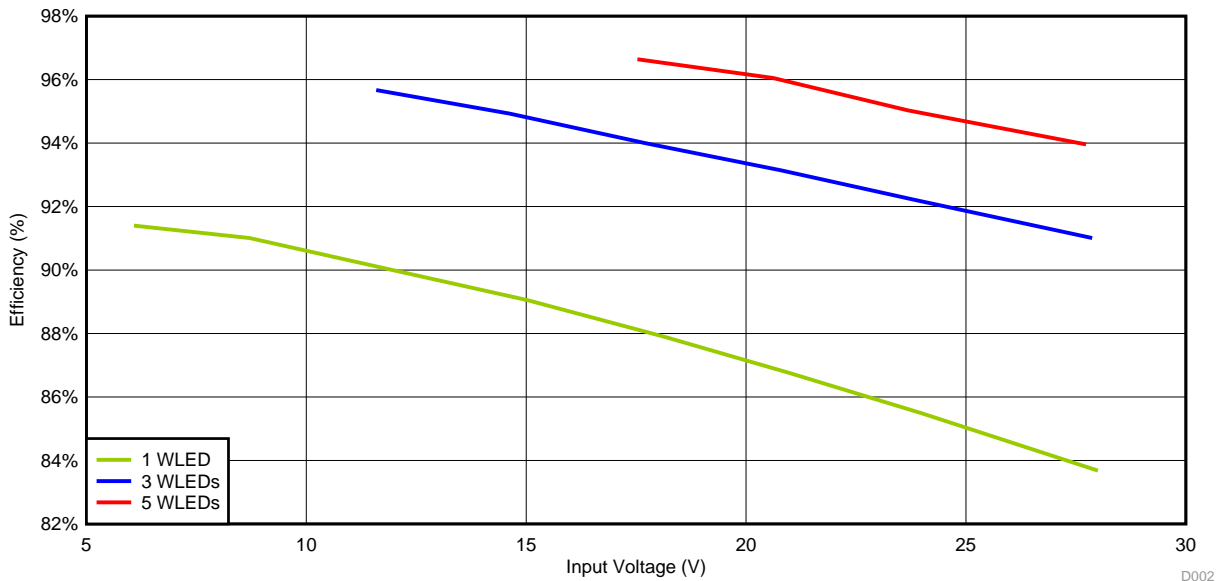

Figure 2. Efficiency vs. Input Voltage in PWM Dimming Mode, 1 A at 100% Duty

4.2 Line Regulation

Figure 3 shows the output current deviation ratio vs. input voltage in analog dimming mode. PWM duty is 100%. 1 White LED is used as load. The LED current is set at 1.5 A and 350 mA, respectively. The typical forward voltage of the White LED is 3.1 V at 1.5 A, and 2.8 V at 0.35 A.

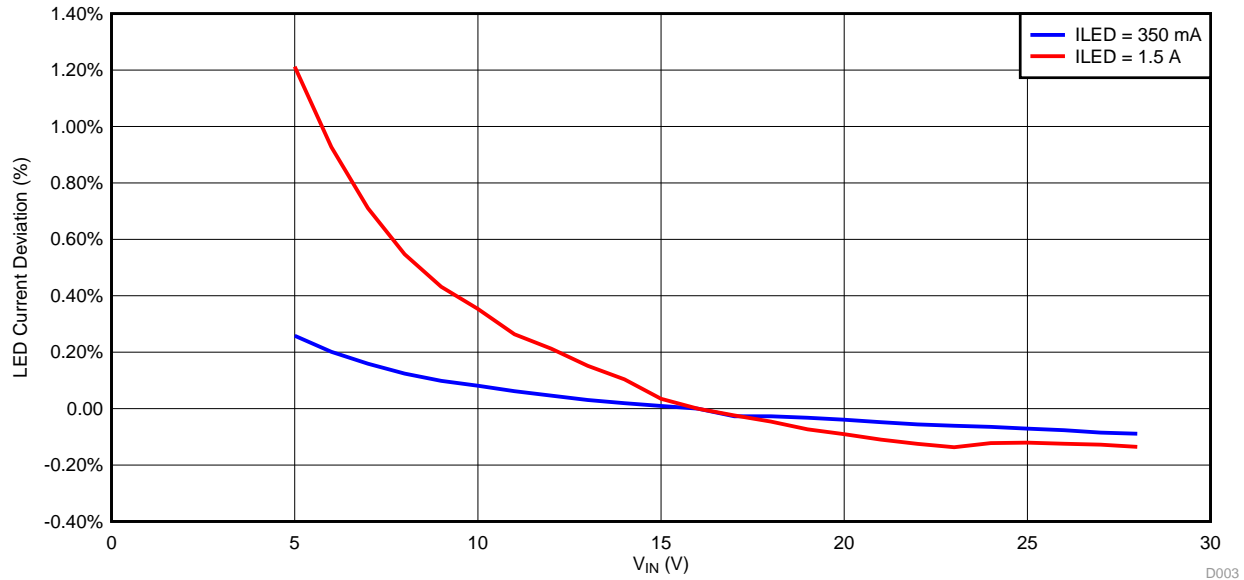

Figure 3. LED Current Deviation vs. Input Voltage in Analog Dimming Mode, 1 WLED

4.3 Load Regulation

Figure 4 shows the output current deviation ratio vs. output voltage in analog dimming mode. PWM duty is 100%. White LEDs are used as load, LED number in series is 1, 2, 3, 4, 5, and 6, respectively. LED current is set at 1.5 A and 350 mA, respectively. The typical forward voltage of the White LED is 3.1 V at 1.5 A, and 2.8 V at 0.35 A. Changing the LED number in series from 1 piece to 6 pieces will change the output voltage from approximately 3 V to approximately 18 V. Input voltage is fixed at 24 V.

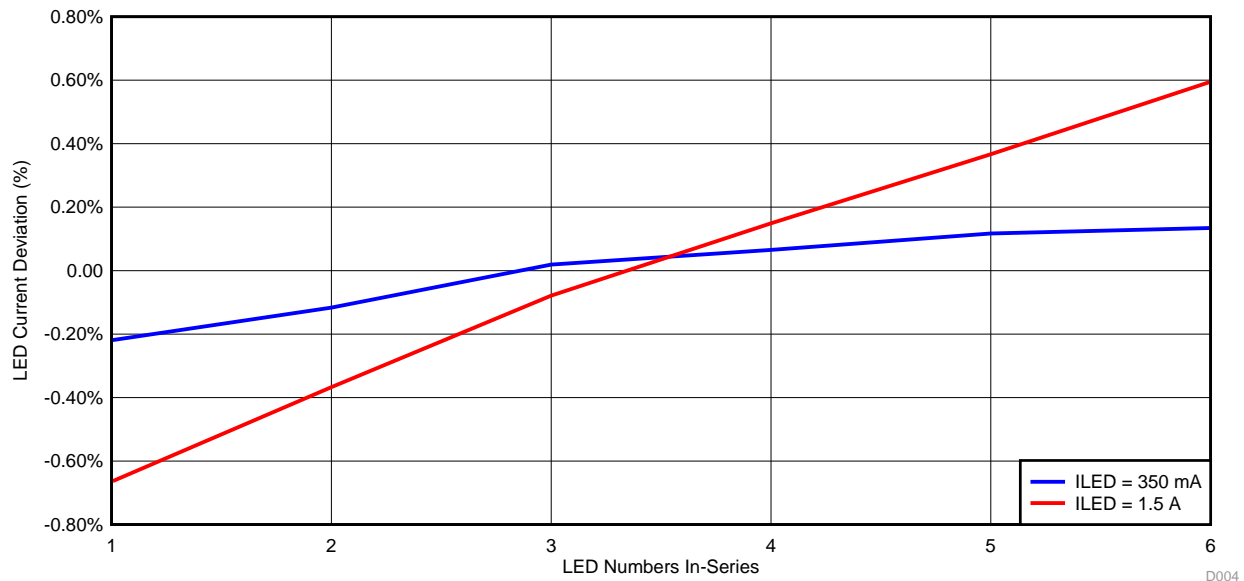

Figure 4. LED Current Deviation vs. LED Numbers in Series in Analog Dimming Mode, V_{IN} = 24 V

4.4 Analog Dimming

Figure 5 shows the output current ratio to the full-scale output current versus PWM duty cycle in analog dimming mode. $V_{IN} = 12\text{ V}$, 3 IR LEDs in series used as load. The LED current is set at 1.5 A with 100% PWM duty. PWM frequency is 50 kHz.

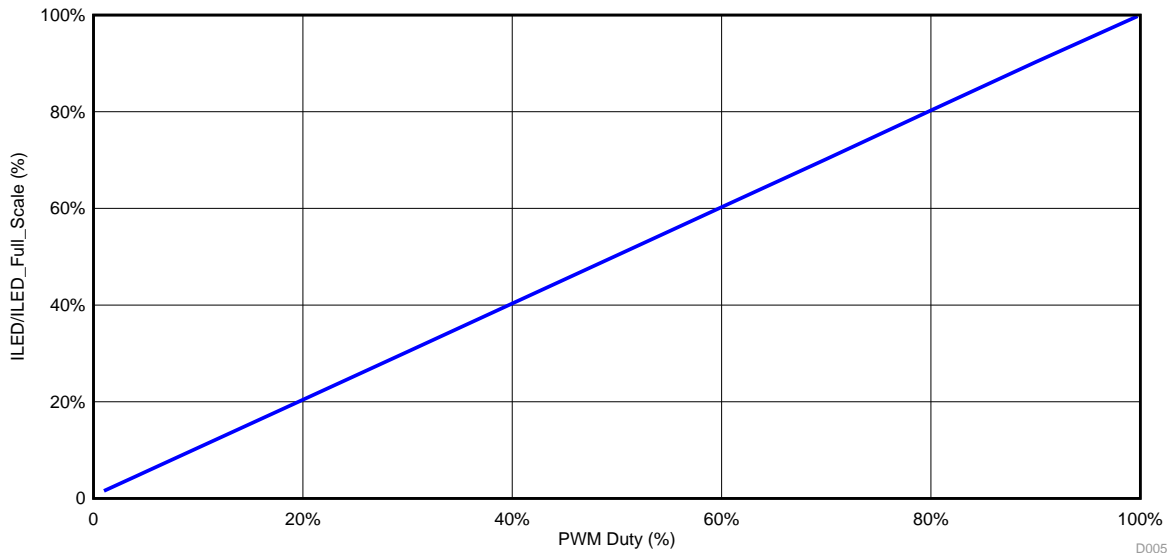

Figure 5. Output Current Ratio vs. PWM duty cycle in Analog Dimming Mode

4.5 PWM Dimming Waveforms

Figure 6, Figure 7, and Figure 8 illustrate the PWM dimming waveforms at 2%, 50%, and 99% duty cycles, respectively, in PWM dimming mode. Input voltage is 24 V, with 3 White LEDs in series used as load. The LED current is set at 1.5 A, PWM frequency is 200 Hz. The resistor, R3, of the RC filter at the FB pin is changed to 200 Ω for better loop response.

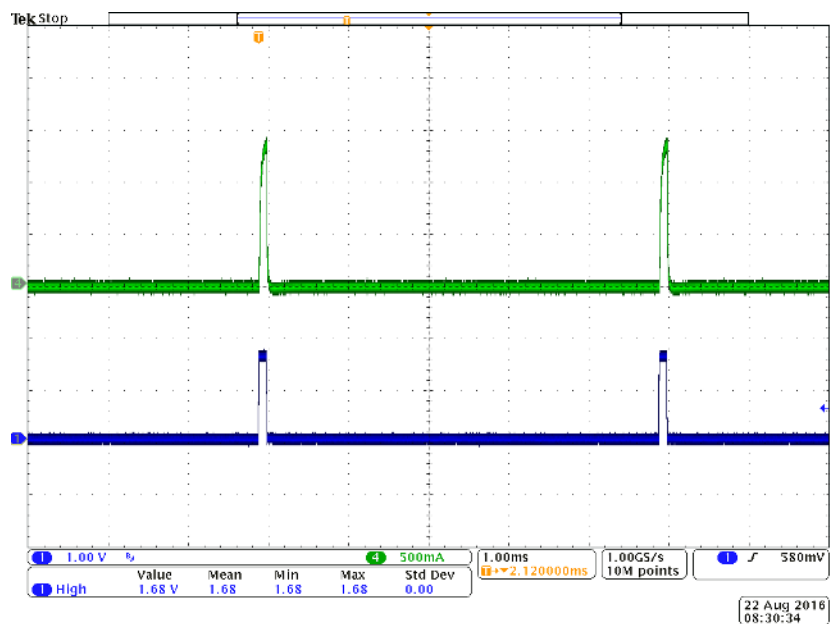

Figure 6. 2% Duty Cycle 200-Hz PWM Dimming, Top = LED Current, Bottom = PWM

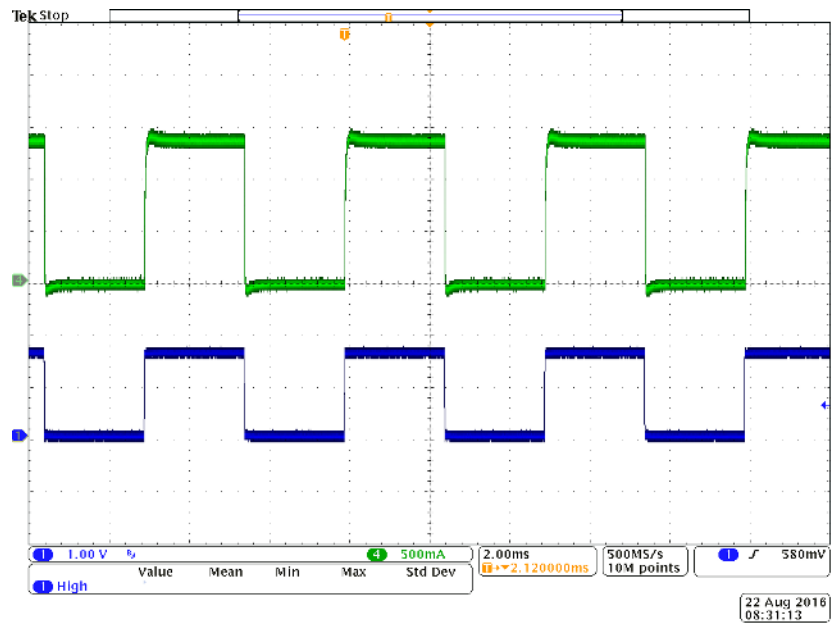

Figure 7. 50% Duty Cycle 200-Hz PWM Dimming, Top = LED Current, Bottom = PWM

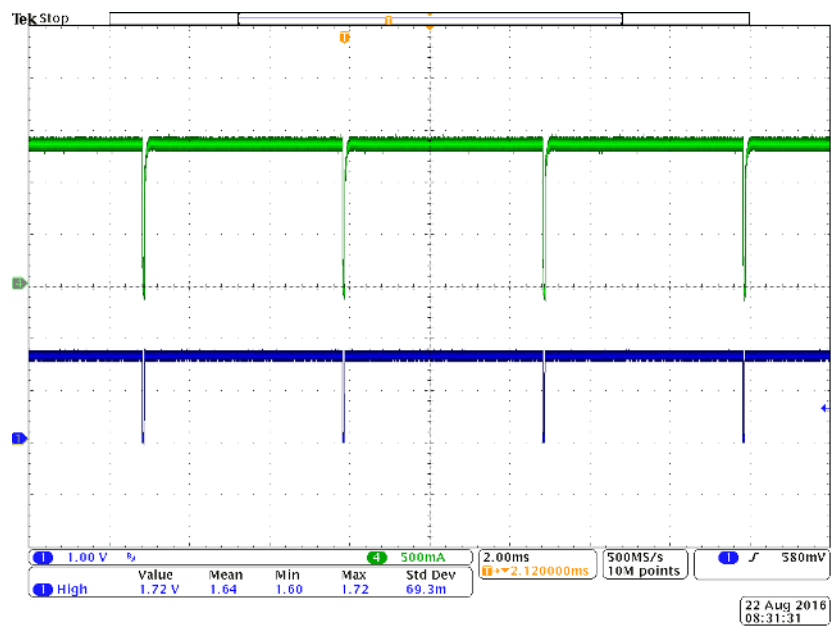

Figure 8. 99% Duty Cycle 200-Hz PWM Dimming, Top = LED Current, Bottom = PWM

4.6 LED Open and Short Protection

Figure 9 shows the LED open protection waveform in PWM dimming mode. The LED load is open at first, then apply V_{IN} and PWM. $V_{IN} = 12\text{ V}$, PWM is 1.6 V DC. The LED current is set at 1.5 A. The curves in this waveform are defined as: CH1: PWM; CH2: SW; CH3: VOUT; CH4: Inductor Current.

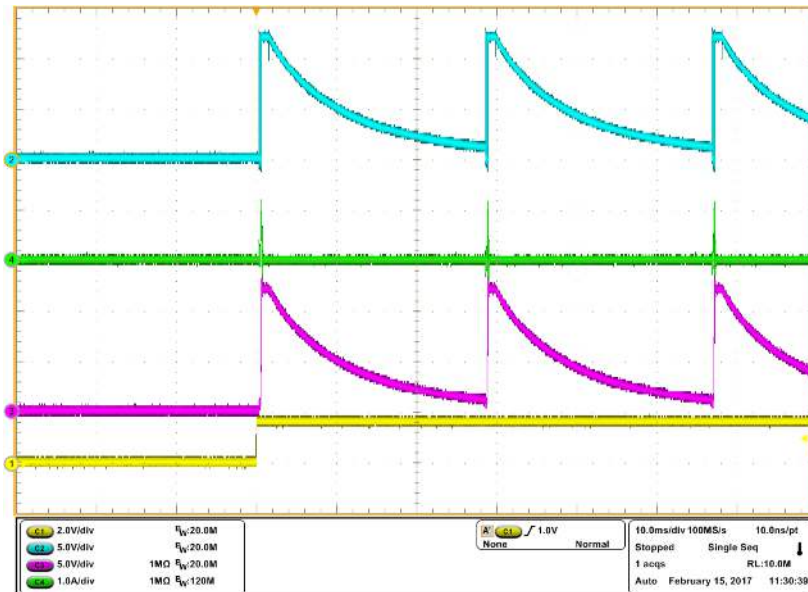

Figure 9. LED Open Failure Protection

Figure 10 shows the LED short protection waveform in PWM dimming mode. The LED load is shorted at first, then apply V_{IN} and PWM. $V_{IN} = 12\text{ V}$, PWM is 1.6 V DC. The LED current is set at 1.5 A. The curves in this waveform are defined as: CH1: PWM; CH2: SW; CH3: FB; CH4: Inductor Current.

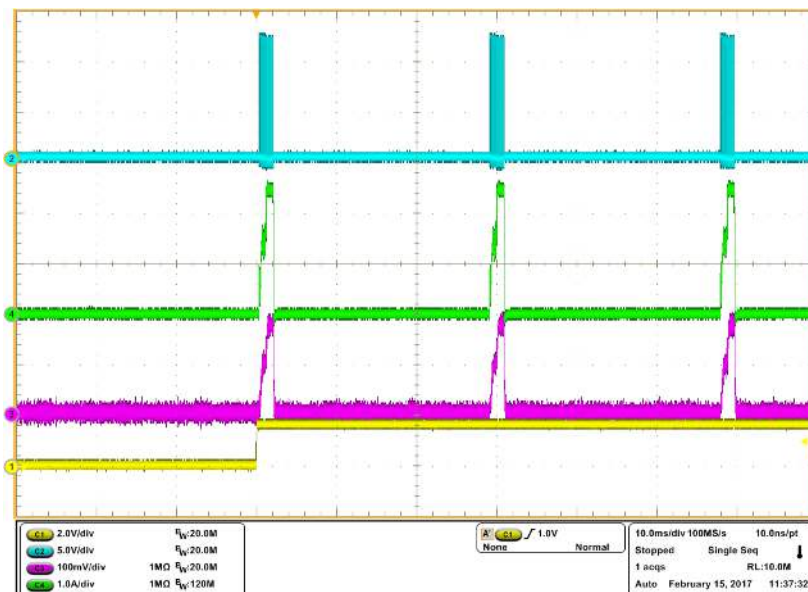

Figure 10. LED Short Failure Protection

6 TPS54201EVM-818 PCB Layout

Figure 12 and Figure 13 show the design of the TPS54201EVM-818 printed-circuit board.

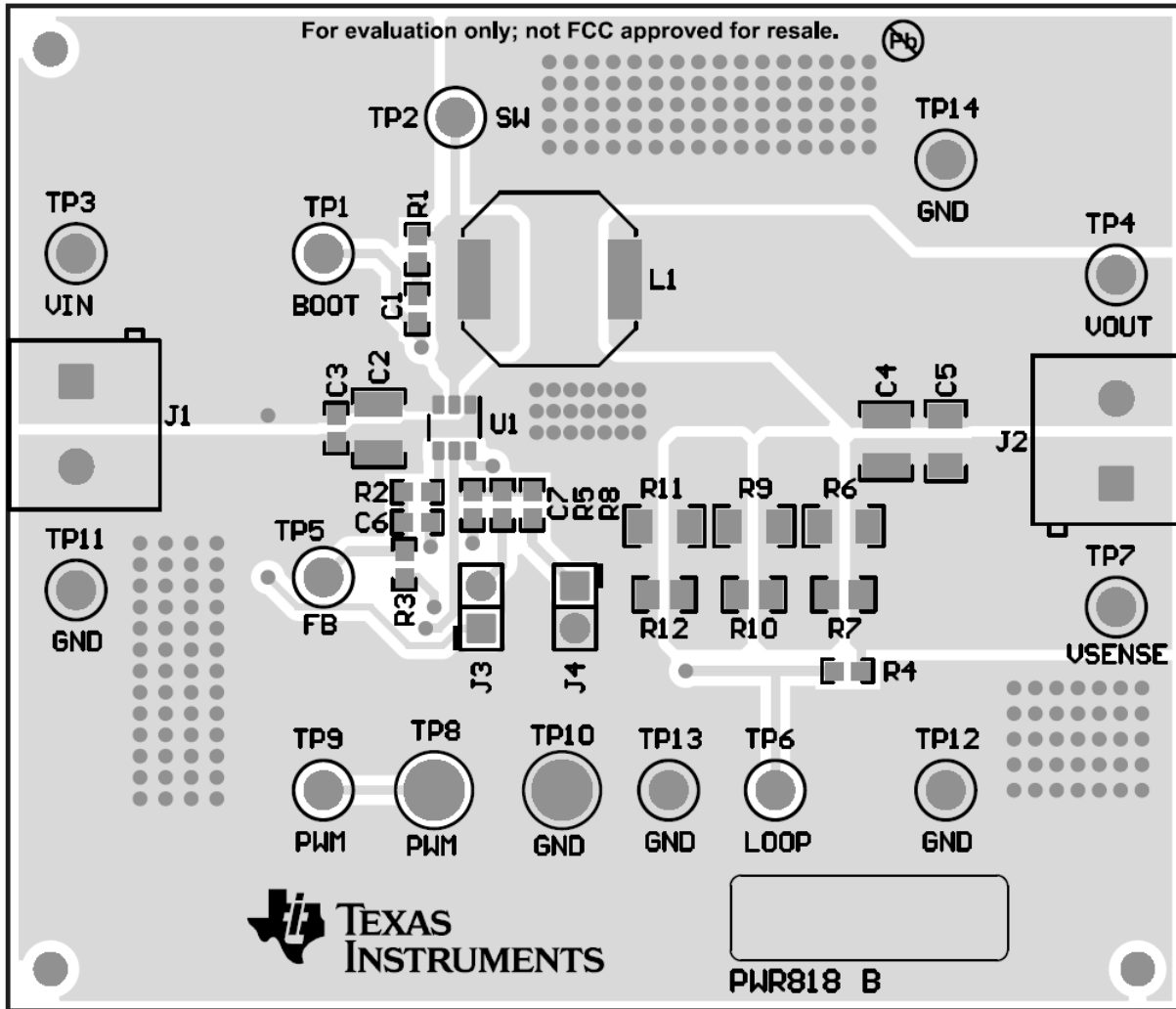

Figure 12. Top Layer and Top Overlay (Top View)

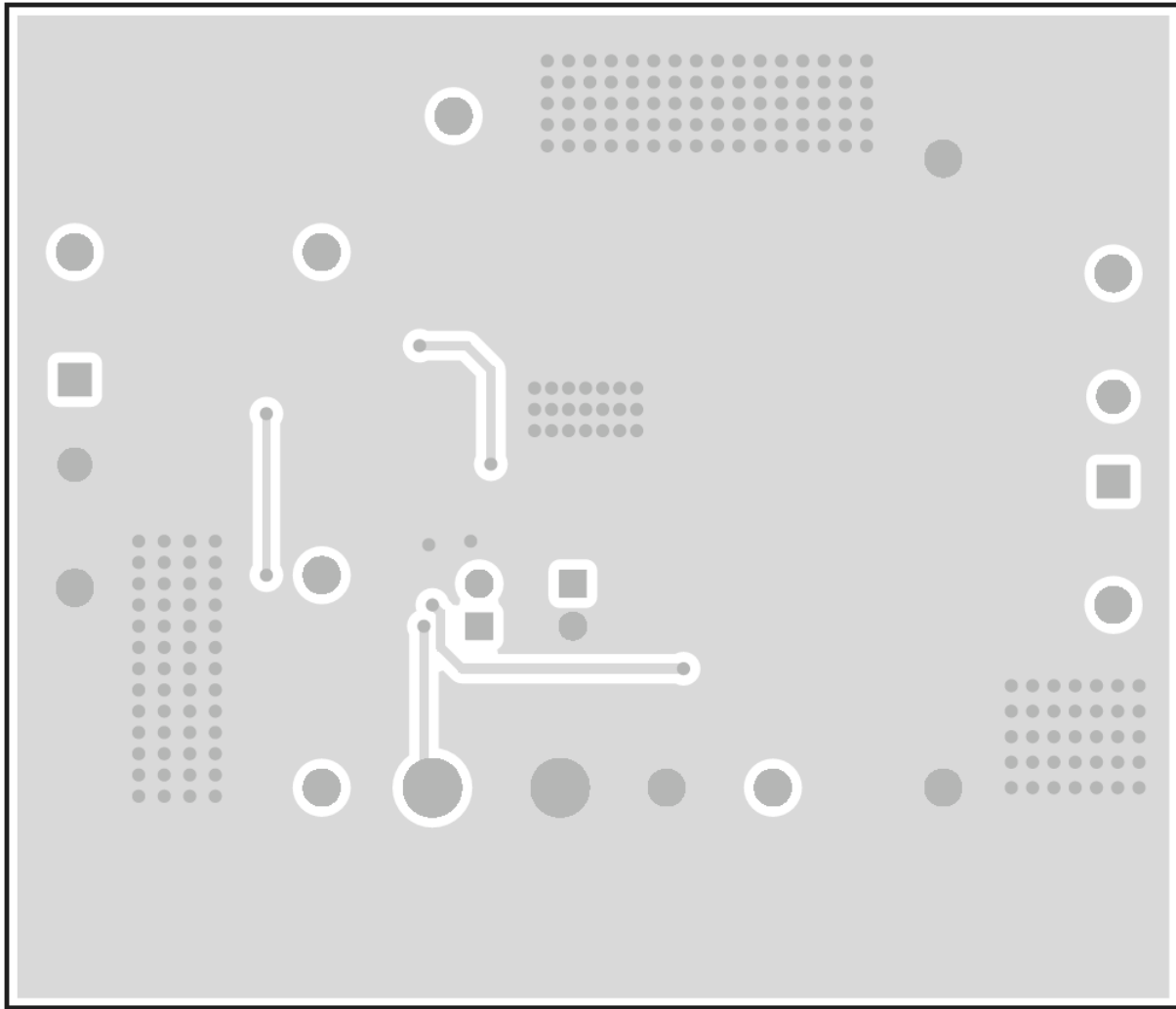

Figure 13. Bottom Layer and Bottom Overlay (Bottom View)

7 Bill of Materials

Table 3 displays the TPS54201EVM-818 components list according to the schematic in Figure 11.

Table 3. TPS54201EVM-818 Components List

Designator	Qty	Value	Description	Package	Part Number	Manufacturer
C1, C3	2	0.1uF	CAP, CERM, 0.1 μ F, 50 V, +/- 10%, X7R, 0603	0603	GRM188R71H104KA93D	Murata
C2, C4	2	10uF	CAP, CERM, 10 μ F, 35 V, +/- 10%, X7R, 1210	1210	GRM32ER7YA106KA12L	Murata
C6	1	0.082uF	CAP, CERM, 0.082 μ F, 50 V, +/- 10%, X7R, 0603	0603	GRM188R71H823KA93D	Murata
J1, J2	2		Terminal Block, 5.08 mm, 2x1, Brass, TH	2x1 5.08 mm Terminal Block	ED120/2DS	On-Shore Technology
J3, J4	2		Header, 100mil, 2x1, Gold, TH	2x1 Header	TSW-102-07-G-S	Samtec
L1	1	10uH	Inductor, Shielded Drum Core, Ferrite, 10 μ H, 3.6 A, 0.028 ohm, SMD	WE-TPC-XLH1	744066100	Würth Elektronik
R1, R2	2	0	RES, 0, 5%, 0.1 W, 0603	0603	CRCW06030000Z0EA	Vishay-Dale
R3	1	910	RES, 910, 5%, 0.1 W, 0603	0603	CRCW0603910RJNEA	Vishay-Dale
R4	1	49.9	RES, 49.9, 1%, 0.1 W, 0603	0603	CRCW060349R9FKEA	Vishay-Dale
R5	1	200k	RES, 200 k, 1%, 0.1 W, 0603	0603	CRCW0603200KFKEA	Vishay-Dale
R6	1	0.033	RES, 0.033, 1%, 1 W, AEC-Q200 Grade 0, 1206	1206	ERJ-8CWFR033V	Panasonic
R8	1	13.3k	RES, 13.3 k, 1%, 0.1 W, 0603	0603	CRCW060313K3FKEA	Vishay-Dale
R9, R11	2	0.05	RES, 0.05, 1%, 0.5 W, 1206	1206	CSR1206FK50L0	Stackpole Electronics Inc
TP1, TP2, TP5, TP6, TP7	5		Test Point, Multipurpose, White, TH	White Multipurpose Testpoint	5012	Keystone
TP3, TP4	2		Test Point, Multipurpose, Red, TH	Red Multipurpose Testpoint	5010	Keystone
TP8, TP10	2		Terminal, Turret, TH, Double	Keystone1502-2	1502-2	Keystone
TP9	1		Test Point, Multipurpose, Yellow, TH	Yellow Multipurpose Testpoint	5014	Keystone
TP11, TP12, TP13, TP14	4		Test Point, Multipurpose, Black, TH	Black Multipurpose Testpoint	5011	Keystone
U1	1		4.5V TO 28V INPUT VOLTAGE, 1.5 A OUTPUT CURRENT, SYNCHRONOUS BUCK WLED Driver, DDC0006A	DDC0006A	TPS54201DDCR	Texas Instruments

STANDARD TERMS FOR EVALUATION MODULES

1. *Delivery:* TI delivers TI evaluation boards, kits, or modules, including any accompanying demonstration software, components, and/or documentation which may be provided together or separately (collectively, an "EVM" or "EVMs") to the User ("User") in accordance with the terms set forth herein. User's acceptance of the EVM is expressly subject to the following terms.
 - 1.1 EVMs are intended solely for product or software developers for use in a research and development setting to facilitate feasibility evaluation, experimentation, or scientific analysis of TI semiconductor products. EVMs have no direct function and are not finished products. EVMs shall not be directly or indirectly assembled as a part or subassembly in any finished product. For clarification, any software or software tools provided with the EVM ("Software") shall not be subject to the terms and conditions set forth herein but rather shall be subject to the applicable terms that accompany such Software
 - 1.2 EVMs are not intended for consumer or household use. EVMs may not be sold, sublicensed, leased, rented, loaned, assigned, or otherwise distributed for commercial purposes by Users, in whole or in part, or used in any finished product or production system.
2. *Limited Warranty and Related Remedies/Disclaimers:*
 - 2.1 These terms do not apply to Software. The warranty, if any, for Software is covered in the applicable Software License Agreement.
 - 2.2 TI warrants that the TI EVM will conform to TI's published specifications for ninety (90) days after the date TI delivers such EVM to User. Notwithstanding the foregoing, TI shall not be liable for a nonconforming EVM if (a) the nonconformity was caused by neglect, misuse or mistreatment by an entity other than TI, including improper installation or testing, or for any EVMs that have been altered or modified in any way by an entity other than TI, (b) the nonconformity resulted from User's design, specifications or instructions for such EVMs or improper system design, or (c) User has not paid on time. Testing and other quality control techniques are used to the extent TI deems necessary. TI does not test all parameters of each EVM. User's claims against TI under this Section 2 are void if User fails to notify TI of any apparent defects in the EVMs within ten (10) business days after delivery, or of any hidden defects with ten (10) business days after the defect has been detected.
 - 2.3 TI's sole liability shall be at its option to repair or replace EVMs that fail to conform to the warranty set forth above, or credit User's account for such EVM. TI's liability under this warranty shall be limited to EVMs that are returned during the warranty period to the address designated by TI and that are determined by TI not to conform to such warranty. If TI elects to repair or replace such EVM, TI shall have a reasonable time to repair such EVM or provide replacements. Repaired EVMs shall be warranted for the remainder of the original warranty period. Replaced EVMs shall be warranted for a new full ninety (90) day warranty period.
3. *Regulatory Notices:*
 - 3.1 *United States*
 - 3.1.1 *Notice applicable to EVMs not FCC-Approved:*

FCC NOTICE: This kit is designed to allow product developers to evaluate electronic components, circuitry, or software associated with the kit to determine whether to incorporate such items in a finished product and software developers to write software applications for use with the end product. This kit is not a finished product and when assembled may not be resold or otherwise marketed unless all required FCC equipment authorizations are first obtained. Operation is subject to the condition that this product not cause harmful interference to licensed radio stations and that this product accept harmful interference. Unless the assembled kit is designed to operate under part 15, part 18 or part 95 of this chapter, the operator of the kit must operate under the authority of an FCC license holder or must secure an experimental authorization under part 5 of this chapter.
 - 3.1.2 *For EVMs annotated as FCC – FEDERAL COMMUNICATIONS COMMISSION Part 15 Compliant:*

CAUTION

This device complies with part 15 of the FCC Rules. Operation is subject to the following two conditions: (1) This device may not cause harmful interference, and (2) this device must accept any interference received, including interference that may cause undesired operation.

Changes or modifications not expressly approved by the party responsible for compliance could void the user's authority to operate the equipment.

FCC Interference Statement for Class A EVM devices

NOTE: This equipment has been tested and found to comply with the limits for a Class A digital device, pursuant to part 15 of the FCC Rules. These limits are designed to provide reasonable protection against harmful interference when the equipment is operated in a commercial environment. This equipment generates, uses, and can radiate radio frequency energy and, if not installed and used in accordance with the instruction manual, may cause harmful interference to radio communications. Operation of this equipment in a residential area is likely to cause harmful interference in which case the user will be required to correct the interference at his own expense.

FCC Interference Statement for Class B EVM devices

NOTE: This equipment has been tested and found to comply with the limits for a Class B digital device, pursuant to part 15 of the FCC Rules. These limits are designed to provide reasonable protection against harmful interference in a residential installation. This equipment generates, uses and can radiate radio frequency energy and, if not installed and used in accordance with the instructions, may cause harmful interference to radio communications. However, there is no guarantee that interference will not occur in a particular installation. If this equipment does cause harmful interference to radio or television reception, which can be determined by turning the equipment off and on, the user is encouraged to try to correct the interference by one or more of the following measures:

- Reorient or relocate the receiving antenna.
- Increase the separation between the equipment and receiver.
- Connect the equipment into an outlet on a circuit different from that to which the receiver is connected.
- Consult the dealer or an experienced radio/TV technician for help.

3.2 Canada

3.2.1 For EVMs issued with an Industry Canada Certificate of Conformance to RSS-210 or RSS-247

Concerning EVMs Including Radio Transmitters:

This device complies with Industry Canada license-exempt RSSs. Operation is subject to the following two conditions:

(1) this device may not cause interference, and (2) this device must accept any interference, including interference that may cause undesired operation of the device.

Concernant les EVMs avec appareils radio:

Le présent appareil est conforme aux CNR d'Industrie Canada applicables aux appareils radio exempts de licence. L'exploitation est autorisée aux deux conditions suivantes: (1) l'appareil ne doit pas produire de brouillage, et (2) l'utilisateur de l'appareil doit accepter tout brouillage radioélectrique subi, même si le brouillage est susceptible d'en compromettre le fonctionnement.

Concerning EVMs Including Detachable Antennas:

Under Industry Canada regulations, this radio transmitter may only operate using an antenna of a type and maximum (or lesser) gain approved for the transmitter by Industry Canada. To reduce potential radio interference to other users, the antenna type and its gain should be so chosen that the equivalent isotropically radiated power (e.i.r.p.) is not more than that necessary for successful communication. This radio transmitter has been approved by Industry Canada to operate with the antenna types listed in the user guide with the maximum permissible gain and required antenna impedance for each antenna type indicated. Antenna types not included in this list, having a gain greater than the maximum gain indicated for that type, are strictly prohibited for use with this device.

Concernant les EVMs avec antennes détachables

Conformément à la réglementation d'Industrie Canada, le présent émetteur radio peut fonctionner avec une antenne d'un type et d'un gain maximal (ou inférieur) approuvé pour l'émetteur par Industrie Canada. Dans le but de réduire les risques de brouillage radioélectrique à l'intention des autres utilisateurs, il faut choisir le type d'antenne et son gain de sorte que la puissance isotrope rayonnée équivalente (p.i.r.e.) ne dépasse pas l'intensité nécessaire à l'établissement d'une communication satisfaisante. Le présent émetteur radio a été approuvé par Industrie Canada pour fonctionner avec les types d'antenne énumérés dans le manuel d'usage et ayant un gain admissible maximal et l'impédance requise pour chaque type d'antenne. Les types d'antenne non inclus dans cette liste, ou dont le gain est supérieur au gain maximal indiqué, sont strictement interdits pour l'exploitation de l'émetteur.

3.3 Japan

3.3.1 *Notice for EVMs delivered in Japan:* Please see http://www.tij.co.jp/lstds/ti_ja/general/eStore/notice_01.page 日本国内に輸入される評価用キット、ボードについては、次のところをご覧ください。
http://www.tij.co.jp/lstds/ti_ja/general/eStore/notice_01.page

3.3.2 *Notice for Users of EVMs Considered "Radio Frequency Products" in Japan:* EVMs entering Japan may not be certified by TI as conforming to Technical Regulations of Radio Law of Japan.

If User uses EVMs in Japan, not certified to Technical Regulations of Radio Law of Japan, User is required to follow the instructions set forth by Radio Law of Japan, which includes, but is not limited to, the instructions below with respect to EVMs (which for the avoidance of doubt are stated strictly for convenience and should be verified by User):

1. Use EVMs in a shielded room or any other test facility as defined in the notification #173 issued by Ministry of Internal Affairs and Communications on March 28, 2006, based on Sub-section 1.1 of Article 6 of the Ministry's Rule for Enforcement of Radio Law of Japan,
2. Use EVMs only after User obtains the license of Test Radio Station as provided in Radio Law of Japan with respect to EVMs, or
3. Use of EVMs only after User obtains the Technical Regulations Conformity Certification as provided in Radio Law of Japan with respect to EVMs. Also, do not transfer EVMs, unless User gives the same notice above to the transferee. Please note that if User does not follow the instructions above, User will be subject to penalties of Radio Law of Japan.

【無線電波を送信する製品の開発キットをお使いになる際の注意事項】 開発キットの中には技術基準適合証明を受けていないものがあります。技術適合証明を受けていないものご使用に際しては、電波法遵守のため、以下のいずれかの措置を取っていただく必要がありますのでご注意ください。

1. 電波法施行規則第6条第1項第1号に基づく平成18年3月28日総務省告示第173号で定められた電波暗室等の試験設備でご使用いただく。
2. 実験局の免許を取得後ご使用いただく。
3. 技術基準適合証明を取得後ご使用いただく。

なお、本製品は、上記の「ご使用にあたっての注意」を譲渡先、移転先に通知しない限り、譲渡、移転できないものとします。

上記を遵守頂けない場合は、電波法の罰則が適用される可能性があることをご留意ください。日本テキサス・インスツルメンツ株式会社
東京都新宿区西新宿 6 丁目 2 4 番 1 号
西新宿三井ビル

3.3.3 *Notice for EVMs for Power Line Communication:* Please see http://www.tij.co.jp/llds/ti_ja/general/eStore/notice_02.page
電力線搬送波通信についての開発キットをお使いになる際の注意事項については、次のところをご覧ください。 http://www.tij.co.jp/llds/ti_ja/general/eStore/notice_02.page

3.4 *European Union*

3.4.1 *For EVMs subject to EU Directive 2014/30/EU (Electromagnetic Compatibility Directive):*

This is a class A product intended for use in environments other than domestic environments that are connected to a low-voltage power-supply network that supplies buildings used for domestic purposes. In a domestic environment this product may cause radio interference in which case the user may be required to take adequate measures.

4 *EVM Use Restrictions and Warnings:*

4.1 EVMS ARE NOT FOR USE IN FUNCTIONAL SAFETY AND/OR SAFETY CRITICAL EVALUATIONS, INCLUDING BUT NOT LIMITED TO EVALUATIONS OF LIFE SUPPORT APPLICATIONS.

4.2 User must read and apply the user guide and other available documentation provided by TI regarding the EVM prior to handling or using the EVM, including without limitation any warning or restriction notices. The notices contain important safety information related to, for example, temperatures and voltages.

4.3 *Safety-Related Warnings and Restrictions:*

4.3.1 User shall operate the EVM within TI's recommended specifications and environmental considerations stated in the user guide, other available documentation provided by TI, and any other applicable requirements and employ reasonable and customary safeguards. Exceeding the specified performance ratings and specifications (including but not limited to input and output voltage, current, power, and environmental ranges) for the EVM may cause personal injury or death, or property damage. If there are questions concerning performance ratings and specifications, User should contact a TI field representative prior to connecting interface electronics including input power and intended loads. Any loads applied outside of the specified output range may also result in unintended and/or inaccurate operation and/or possible permanent damage to the EVM and/or interface electronics. Please consult the EVM user guide prior to connecting any load to the EVM output. If there is uncertainty as to the load specification, please contact a TI field representative. During normal operation, even with the inputs and outputs kept within the specified allowable ranges, some circuit components may have elevated case temperatures. These components include but are not limited to linear regulators, switching transistors, pass transistors, current sense resistors, and heat sinks, which can be identified using the information in the associated documentation. When working with the EVM, please be aware that the EVM may become very warm.

4.3.2 EVMs are intended solely for use by technically qualified, professional electronics experts who are familiar with the dangers and application risks associated with handling electrical mechanical components, systems, and subsystems. User assumes all responsibility and liability for proper and safe handling and use of the EVM by User or its employees, affiliates, contractors or designees. User assumes all responsibility and liability to ensure that any interfaces (electronic and/or mechanical) between the EVM and any human body are designed with suitable isolation and means to safely limit accessible leakage currents to minimize the risk of electrical shock hazard. User assumes all responsibility and liability for any improper or unsafe handling or use of the EVM by User or its employees, affiliates, contractors or designees.

4.4 User assumes all responsibility and liability to determine whether the EVM is subject to any applicable international, federal, state, or local laws and regulations related to User's handling and use of the EVM and, if applicable, User assumes all responsibility and liability for compliance in all respects with such laws and regulations. User assumes all responsibility and liability for proper disposal and recycling of the EVM consistent with all applicable international, federal, state, and local requirements.

5. *Accuracy of Information:* To the extent TI provides information on the availability and function of EVMs, TI attempts to be as accurate as possible. However, TI does not warrant the accuracy of EVM descriptions, EVM availability or other information on its websites as accurate, complete, reliable, current, or error-free.

6. *Disclaimers:*
- 6.1 EXCEPT AS SET FORTH ABOVE, EVMS AND ANY MATERIALS PROVIDED WITH THE EVM (INCLUDING, BUT NOT LIMITED TO, REFERENCE DESIGNS AND THE DESIGN OF THE EVM ITSELF) ARE PROVIDED "AS IS" AND "WITH ALL FAULTS." TI DISCLAIMS ALL OTHER WARRANTIES, EXPRESS OR IMPLIED, REGARDING SUCH ITEMS, INCLUDING BUT NOT LIMITED TO ANY EPIDEMIC FAILURE WARRANTY OR IMPLIED WARRANTIES OF MERCHANTABILITY OR FITNESS FOR A PARTICULAR PURPOSE OR NON-INFRINGEMENT OF ANY THIRD PARTY PATENTS, COPYRIGHTS, TRADE SECRETS OR OTHER INTELLECTUAL PROPERTY RIGHTS.
- 6.2 EXCEPT FOR THE LIMITED RIGHT TO USE THE EVM SET FORTH HEREIN, NOTHING IN THESE TERMS SHALL BE CONSTRUED AS GRANTING OR CONFERRING ANY RIGHTS BY LICENSE, PATENT, OR ANY OTHER INDUSTRIAL OR INTELLECTUAL PROPERTY RIGHT OF TI, ITS SUPPLIERS/LICENSORS OR ANY OTHER THIRD PARTY, TO USE THE EVM IN ANY FINISHED END-USER OR READY-TO-USE FINAL PRODUCT, OR FOR ANY INVENTION, DISCOVERY OR IMPROVEMENT, REGARDLESS OF WHEN MADE, CONCEIVED OR ACQUIRED.
7. *USER'S INDEMNITY OBLIGATIONS AND REPRESENTATIONS.* USER WILL DEFEND, INDEMNIFY AND HOLD TI, ITS LICENSORS AND THEIR REPRESENTATIVES HARMLESS FROM AND AGAINST ANY AND ALL CLAIMS, DAMAGES, LOSSES, EXPENSES, COSTS AND LIABILITIES (COLLECTIVELY, "CLAIMS") ARISING OUT OF OR IN CONNECTION WITH ANY HANDLING OR USE OF THE EVM THAT IS NOT IN ACCORDANCE WITH THESE TERMS. THIS OBLIGATION SHALL APPLY WHETHER CLAIMS ARISE UNDER STATUTE, REGULATION, OR THE LAW OF TORT, CONTRACT OR ANY OTHER LEGAL THEORY, AND EVEN IF THE EVM FAILS TO PERFORM AS DESCRIBED OR EXPECTED.
8. *Limitations on Damages and Liability:*
- 8.1 *General Limitations.* IN NO EVENT SHALL TI BE LIABLE FOR ANY SPECIAL, COLLATERAL, INDIRECT, PUNITIVE, INCIDENTAL, CONSEQUENTIAL, OR EXEMPLARY DAMAGES IN CONNECTION WITH OR ARISING OUT OF THESE TERMS OR THE USE OF THE EVMS , REGARDLESS OF WHETHER TI HAS BEEN ADVISED OF THE POSSIBILITY OF SUCH DAMAGES. EXCLUDED DAMAGES INCLUDE, BUT ARE NOT LIMITED TO, COST OF REMOVAL OR REINSTALLATION, ANCILLARY COSTS TO THE PROCUREMENT OF SUBSTITUTE GOODS OR SERVICES, RETESTING, OUTSIDE COMPUTER TIME, LABOR COSTS, LOSS OF GOODWILL, LOSS OF PROFITS, LOSS OF SAVINGS, LOSS OF USE, LOSS OF DATA, OR BUSINESS INTERRUPTION. NO CLAIM, SUIT OR ACTION SHALL BE BROUGHT AGAINST TI MORE THAN TWELVE (12) MONTHS AFTER THE EVENT THAT GAVE RISE TO THE CAUSE OF ACTION HAS OCCURRED.
- 8.2 *Specific Limitations.* IN NO EVENT SHALL TI'S AGGREGATE LIABILITY FROM ANY USE OF AN EVM PROVIDED HEREUNDER, INCLUDING FROM ANY WARRANTY, INDEMNITY OR OTHER OBLIGATION ARISING OUT OF OR IN CONNECTION WITH THESE TERMS, , EXCEED THE TOTAL AMOUNT PAID TO TI BY USER FOR THE PARTICULAR EVM(S) AT ISSUE DURING THE PRIOR TWELVE (12) MONTHS WITH RESPECT TO WHICH LOSSES OR DAMAGES ARE CLAIMED. THE EXISTENCE OF MORE THAN ONE CLAIM SHALL NOT ENLARGE OR EXTEND THIS LIMIT.
9. *Return Policy.* Except as otherwise provided, TI does not offer any refunds, returns, or exchanges. Furthermore, no return of EVM(s) will be accepted if the package has been opened and no return of the EVM(s) will be accepted if they are damaged or otherwise not in a resalable condition. If User feels it has been incorrectly charged for the EVM(s) it ordered or that delivery violates the applicable order, User should contact TI. All refunds will be made in full within thirty (30) working days from the return of the components(s), excluding any postage or packaging costs.
10. *Governing Law:* These terms and conditions shall be governed by and interpreted in accordance with the laws of the State of Texas, without reference to conflict-of-laws principles. User agrees that non-exclusive jurisdiction for any dispute arising out of or relating to these terms and conditions lies within courts located in the State of Texas and consents to venue in Dallas County, Texas. Notwithstanding the foregoing, any judgment may be enforced in any United States or foreign court, and TI may seek injunctive relief in any United States or foreign court.

IMPORTANT NOTICE FOR TI DESIGN INFORMATION AND RESOURCES

Texas Instruments Incorporated ("TI") technical, application or other design advice, services or information, including, but not limited to, reference designs and materials relating to evaluation modules, (collectively, "TI Resources") are intended to assist designers who are developing applications that incorporate TI products; by downloading, accessing or using any particular TI Resource in any way, you (individually or, if you are acting on behalf of a company, your company) agree to use it solely for this purpose and subject to the terms of this Notice.

TI's provision of TI Resources does not expand or otherwise alter TI's applicable published warranties or warranty disclaimers for TI products, and no additional obligations or liabilities arise from TI providing such TI Resources. TI reserves the right to make corrections, enhancements, improvements and other changes to its TI Resources.

You understand and agree that you remain responsible for using your independent analysis, evaluation and judgment in designing your applications and that you have full and exclusive responsibility to assure the safety of your applications and compliance of your applications (and of all TI products used in or for your applications) with all applicable regulations, laws and other applicable requirements. You represent that, with respect to your applications, you have all the necessary expertise to create and implement safeguards that (1) anticipate dangerous consequences of failures, (2) monitor failures and their consequences, and (3) lessen the likelihood of failures that might cause harm and take appropriate actions. You agree that prior to using or distributing any applications that include TI products, you will thoroughly test such applications and the functionality of such TI products as used in such applications. TI has not conducted any testing other than that specifically described in the published documentation for a particular TI Resource.

You are authorized to use, copy and modify any individual TI Resource only in connection with the development of applications that include the TI product(s) identified in such TI Resource. NO OTHER LICENSE, EXPRESS OR IMPLIED, BY ESTOPPEL OR OTHERWISE TO ANY OTHER TI INTELLECTUAL PROPERTY RIGHT, AND NO LICENSE TO ANY TECHNOLOGY OR INTELLECTUAL PROPERTY RIGHT OF TI OR ANY THIRD PARTY IS GRANTED HEREIN, including but not limited to any patent right, copyright, mask work right, or other intellectual property right relating to any combination, machine, or process in which TI products or services are used. Information regarding or referencing third-party products or services does not constitute a license to use such products or services, or a warranty or endorsement thereof. Use of TI Resources may require a license from a third party under the patents or other intellectual property of the third party, or a license from TI under the patents or other intellectual property of TI.

TI RESOURCES ARE PROVIDED "AS IS" AND WITH ALL FAULTS. TI DISCLAIMS ALL OTHER WARRANTIES OR REPRESENTATIONS, EXPRESS OR IMPLIED, REGARDING TI RESOURCES OR USE THEREOF, INCLUDING BUT NOT LIMITED TO ACCURACY OR COMPLETENESS, TITLE, ANY EPIDEMIC FAILURE WARRANTY AND ANY IMPLIED WARRANTIES OF MERCHANTABILITY, FITNESS FOR A PARTICULAR PURPOSE, AND NON-INFRINGEMENT OF ANY THIRD PARTY INTELLECTUAL PROPERTY RIGHTS.

TI SHALL NOT BE LIABLE FOR AND SHALL NOT DEFEND OR INDEMNIFY YOU AGAINST ANY CLAIM, INCLUDING BUT NOT LIMITED TO ANY INFRINGEMENT CLAIM THAT RELATES TO OR IS BASED ON ANY COMBINATION OF PRODUCTS EVEN IF DESCRIBED IN TI RESOURCES OR OTHERWISE. IN NO EVENT SHALL TI BE LIABLE FOR ANY ACTUAL, DIRECT, SPECIAL, COLLATERAL, INDIRECT, PUNITIVE, INCIDENTAL, CONSEQUENTIAL OR EXEMPLARY DAMAGES IN CONNECTION WITH OR ARISING OUT OF TI RESOURCES OR USE THEREOF, AND REGARDLESS OF WHETHER TI HAS BEEN ADVISED OF THE POSSIBILITY OF SUCH DAMAGES.

You agree to fully indemnify TI and its representatives against any damages, costs, losses, and/or liabilities arising out of your non-compliance with the terms and provisions of this Notice.

This Notice applies to TI Resources. Additional terms apply to the use and purchase of certain types of materials, TI products and services. These include; without limitation, TI's standard terms for semiconductor products (<http://www.ti.com/sc/docs/stdterms.htm>), [evaluation modules](#), and [samples](http://www.ti.com/sc/docs/sampterm.htm) (<http://www.ti.com/sc/docs/sampterm.htm>).

Mailing Address: Texas Instruments, Post Office Box 655303, Dallas, Texas 75265
Copyright © 2017, Texas Instruments Incorporated