

DF-G3 Long Range Expert™ Dual Display Fiber Amplifier with Analog Output

Instruction Manual

Original Instructions
190341 Rev. F
10 September 2021
© Banner Engineering Corp. All rights reserved



190341

Contents

1 Product Description	3
1.1 Models	3
1.2 Overview	4
1.3 Top Panel Interface	4
2 Installation Instructions	6
2.1 Mounting Instructions	6
2.2 Installing the Fibers in a DF-Gx Sensor	6
2.3 Fiber Adapters	7
2.4 Wiring Diagrams	7
3 Operating Instructions	8
3.1 Run Mode	8
3.2 Program Mode	8
3.2.1 TEACH Selection	9
3.2.2 Response Speed	9
3.2.3 Offset Percent	10
3.2.4 Analog Output Slope	10
3.2.5 Analog Output—Voltage Output Models Only	10
3.2.6 Filter Counts	10
3.2.7 Input Wire Function	10
3.2.8 Display Readout	10
3.2.9 Gain Selection	11
3.2.10 Factory Defaults	11
3.2.11 Output Selection	11
3.2.12 Auto Thresholds	11
3.2.13 Delays/Timers	11
3.2.14 Sensitivity Selection	12
3.3 Remote Input	12
3.4 Sync Master/Slave	13
3.5 Adjust Mode	13
3.5.1 CH1 Analog Output	13
3.5.2 CH2 Discrete Output	14
3.6 Troubleshooting	23
3.6.1 Manual Adjustments Disabled	23
3.6.2 Percent Minimum Difference after TEACH	23
3.6.3 Percent Offset after SET	23
3.6.4 Threshold Alert or Threshold Error	24
4 Specifications	25
4.1 Excess Gain Curves	27
4.2 Beam Patterns	29
4.3 Dimensions	31
5 Accessories	32
5.1 Quick-Disconnect Cordsets	32
5.2 Banner Engineering Corp. Limited Warranty	33

1 Product Description

Advanced sensor with dual digital displays for use with plastic and glass fiber optic assemblies; analog current or voltage output models with an independent NPN or PNP discrete output are available.

- World-class long-range sensing capability, more than 6 m (20 ft) with opposed mode fibers
- Models with high visibility red, extreme high-power infrared and water-detecting long infrared sensing beams available
- Cross-talk avoidance function allows seven inspections in dense sensing point applications
- Energy efficient light resistance enables stable detection in industrial lighting environments
- High power amplifier with small core fibers enables precise position sensing of small components
- One analog output (current or voltage) proportional to signal strength and one NPN or PNP discrete output.

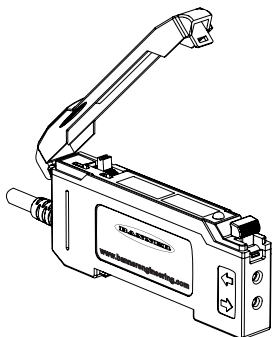

- Easy to read dual digital displays show both signal level and threshold simultaneously
- Lever action fiber clamp provides stable, reliable, and trouble-free fiber clamping
- Simple user interface ensures easy sensor set-up and programming via displays and switches/buttons or remote input teach wire
- *Expert* TEACH and SET methods ensure optimal gain and threshold for all applications, especially for high speed or low contrast applications
- User has full control over all operating parameters: threshold, Light Operate or Dark Operate, output timing functions, gain level, and response speed
- Thermally stable electronics shorten start-up time and maintain signal stability during operation
- ECO (economy) display mode reduces amplifier power consumption by 25%
- Sleek 10 mm wide housing mounts to 35 mm DIN rail



WARNING:

- **Do not use this device for personnel protection**
- Using this device for personnel protection could result in serious injury or death.
- This device does not include the self-checking redundant circuitry necessary to allow its use in personnel safety applications. A device failure or malfunction can cause either an energized (on) or de-energized (off) output condition.

1.1 Models

Model	Sensing Beam Color	Reference Sensing Range ¹	Outputs	Connector ²
DF-G3-NU-2M	Visible red, 635 nm	3000 mm	Voltage and NPN Discrete	2 m (6.5 ft) cable, 5-wire
DF-G3-PU-2M			Voltage and PNP Discrete	
DF-G3-NI-2M			Current and NPN Discrete	
DF-G3-PI-2M			Current and PNP Discrete	
DF-G3IR-NU-2M	Infrared, 850 nm	6000 mm	Voltage and NPN Discrete	2 m (6.5 ft) cable, 5-wire
DF-G3IR-PU-2M			Voltage and PNP Discrete	
DF-G3IR-NI-2M			Current and NPN Discrete	
DF-G3IR-PI-2M			Current and PNP Discrete	
<i>Water Detection Models</i>				
DF-G3LIR-NU-2M	Long infrared, 1450 nm	900 mm	Voltage and NPN Discrete	2 m (6.5 ft) cable, 5-wire

¹ Excess gain = 1 (high sensitivity), opposed mode sensing. PIT46U plastic fiber used for visible models, IT.83.3ST5M6 glass fiber used for IR models.

² Connector options:

- A model with a QD connector requires a mating cordset (see [Quick-Disconnect Cordsets](#) on p. 32)
- For 9 m (29.5 ft) cable, change the suffix 2M to 9M in the 2 m model number (DF-G3-NS-9M)
- For 150 mm (6 in) PVC cable with a M8/Pico-style QD model, change the suffix 2M to Q3 in the 2 m model number (DF-G3-NS-Q3)
- For 150 mm (6 in) PVC cable with a M12/Euro-style model, change the suffix 2M to Q5 in the 2 m model number (DF-G3-NS-Q5)
- For integral M8/Pico-style model, change the suffix 2M to Q7 in the 2 m model number (DF-G3-NS-Q7)
- For Q3 and Q7 Dual Output models, use a 5-pin M8/Pico-style or a 6-pin M8/Pico-style mating cordset

Model	Sensing Beam Color	Reference Sensing Range ¹	Outputs	Connector ²
DF-G3LIR-PU-2M			Voltage and PNP Discrete	
DF-G3LIR-NI-2M			Current and NPN Discrete	
DF-G3LIR-PI-2M			Current and PNP Discrete	

1.2 Overview

Figure 1. DF-G3 Dual Output Analog with Discrete Output

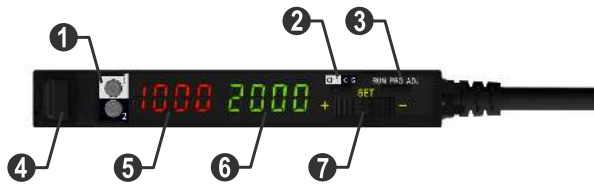

- 1 Analog and Discrete Output LEDs
- 2 CH1/CH2 Switch
- 3 RUN/PRG/ADJ Mode Switch
- 4 Lever Action Fiber Clamp
- 5 Red Signal Level
- 6 Green CH1 Analog Output Signal or CH2 Threshold
- 7 +/-SET/- Rocker Button

1.3 Top Panel Interface

Opening the dust cover provides access to the top panel interface. The top panel interface consists of the RUN/PRG/ADJ mode switch, CH1/CH2 switch, +/-SET/- rocker button, dual red/green digital displays, and output LED(s).



RUN/PRG/ADJ Mode Switch

The RUN/PRG/ADJ mode switch puts the sensor in RUN, PRG (Program), or ADJ (Adjust) mode.

- RUN mode allows the sensor to operate normally and prevents unintentional programming changes via the +/-SET/- rocker button.
- PRG mode allows the sensor to be programmed through the display-driven programming menu (see Program Mode).
- ADJ mode allows the user to perform Expert TEACH/SET methods and Manual Adjust (see [Adjust Mode](#) on p. 13).



CH1/CH2 Switch

The CH1/CH2 switch selects which output's parameters can be accessed and changed in the interface of the display.

- CH1 selects the Analog Output
- CH2 selects the Discrete Output

¹ Excess gain = 1 (high sensitivity), opposed mode sensing. PIT46U plastic fiber used for visible models, IT.83.3ST5M6 glass fiber used for IR models.

² Connector options:

- A model with a QD connector requires a mating cordset (see [Quick-Disconnect Cordsets](#) on p. 32)
- For 9 m (29.5 ft) cable, change the suffix 2M to 9M in the 2 m model number (DF-G3-NS-9M)
- For 150 mm (6 in) PVC cable with a M8/Pico-style QD model, change the suffix 2M to Q3 in the 2 m model number (DF-G3-NS-Q3)
- For 150 mm (6 in) PVC cable with a M12/Euro-style model, change the suffix 2M to Q5 in the 2 m model number (DF-G3-NS-Q5)
- For integral M8/Pico-style model, change the suffix 2M to Q7 in the 2 m model number (DF-G3-NS-Q7)
- For Q3 and Q7 Dual Output models, use a 5-pin M8/Pico-style or a 6-pin M8/Pico-style mating cordset

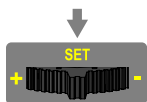

+/-SET/- Rocker Button

The +/-SET/- rocker button is a 3-way button. The +/- positions are engaged by rocking the button left/right. The SET position is engaged by clicking down the button while the rocker is in the middle position. All three button positions are used during PRG mode to navigate the display-driven programming menu.

In ADJ mode, SET is used to perform TEACH/SET methods and +/- are used to manually adjust the threshold(s). In CH1 RUN mode, the rocker button is used to view the analog endpoints and midpoint signal values. The rocker button is disabled during CH2 RUN mode, except when using Window SET (see Window SET).



Red/Green Digital Displays

During RUN and ADJ modes, the Red display shows the signal level, and the Green display shows the analog output in volts or milliamps when CH1 is selected or the threshold when CH2 is selected. During PRG mode, both displays are used to navigate the display-driven programming menu.



Dual Output LEDs

The output LEDs provide a visible indication of when the associated output is active.

- 1 represents the Channel 1 analog output. When on, it indicates that the signal is within the analog range.
- 2 represents the Channel 2 discrete output. When on, it indicates that the output is conducting.

2 Installation Instructions

2.1 Mounting Instructions

Mount on a DIN Rail

1. Hook the DIN rail clip on the bottom of the DF-G3 over the edge of the DIN rail (1).
2. Push the DF-G3 up on the DIN rail (1).
3. Pivot the DF-G3 onto the DIN rail, pressing until it snaps into place (2).

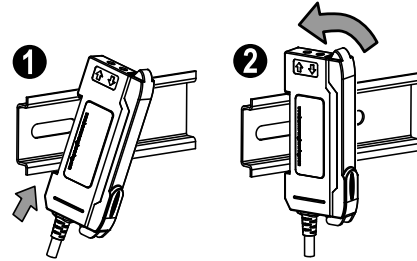

Mount to the Accessory Bracket (SA-DIN-BRACKET)

1. Position the DF-G3 in the SA-DIN-BRACKET.
2. Insert the supplied M3 screws.
3. Tighten the screws.

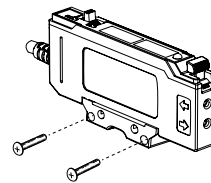

Remove from a DIN rail

1. Push the DF-G3 up on the DIN rail (1).
2. Pivot the DF-G3 away from the DIN rail and remove it (2).

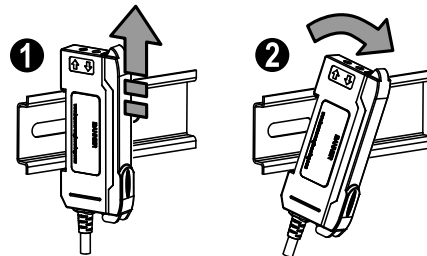

2.2 Installing the Fibers in a DF-Gx Sensor

Follow these steps to install glass or plastic fibers.

1. Open the dust cover.
2. Move the fiber clamp forward to unlock it.
3. Insert the fiber(s) into the fiber port(s) until they stop.
4. Move the fiber clamp backward to lock the fiber(s).
5. Close the dust cover.

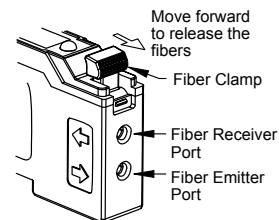

Note: For optimum performance of IR models, if applicable, glass fibers must be used.

2.3 Fiber Adapters



Note: If a thin fiber with less than 2.2 mm outer diameter is used, install the fiber adapter provided with the fiber assembly to ensure a reliable fit in the fiber holder. Align the fibers to the end of the adapters. Banner includes the adapters with all fiber assemblies.

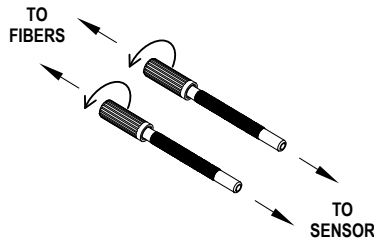

Fiber Outer Diameter (mm)	Adapter Color
Ø 1.0	Black
Ø 1.3	Red
Ø 2.2	No adapter needed

When connecting coaxial-type fiber assemblies to the amplifier, install the single-core (center) fiber to the Transmitter port, and the multi-core (outer) fiber to the Receiver port. This will result in the most reliable detection.

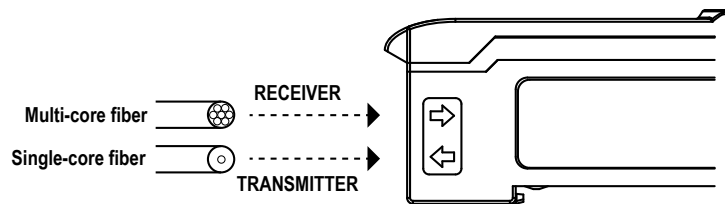

2.4 Wiring Diagrams

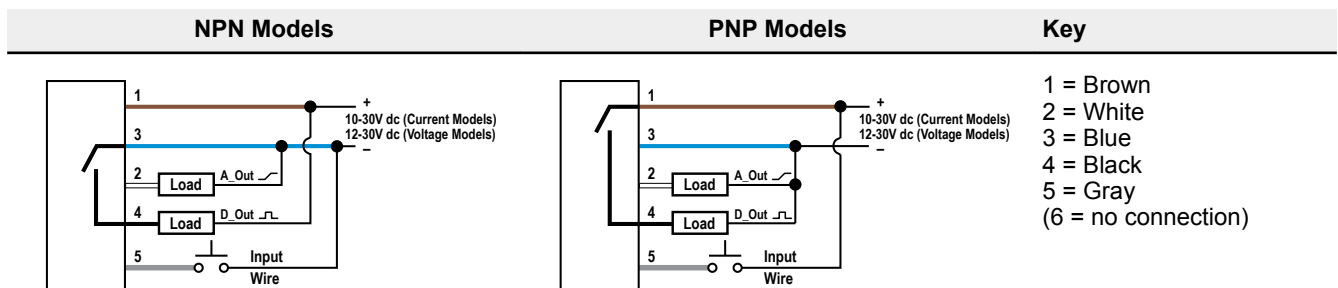

Note: Open lead wires must be connected to a terminal block.



Note: When using multiple sensors in Master/Slave mode, the gray wires from each sensor should be connected together. The remote programming function cannot be used.

Description	Response Speed	Repetition Period	Repeatability	Cross-Talk Avoidance	Energy Efficient Light Resistance	Maximum Range, Red ³	Maximum Range, IR850 ⁴
High Speed	500 µs	100 µs	100 µs	No	No	1200 mm	2400 mm
Fast	1000 µs	100 µs	150 µs	Yes	No	1500 mm	3000 mm
Standard	2 ms	100 µs	180 µs	Yes	Yes	1500 mm	3000 mm
Long Range	8 ms	100 µs	180 µs	Yes	Yes	1950 mm	3900 mm
Extra Long Range	24 ms	100 µs	180 µs	Yes	Yes	3000 mm	6000 mm

3.2.3 Offset Percent

For the Analog Output CH1, the Offset Percent is used in One-Point Set mode to generate a threshold window above and below the TEACH point. This window is equivalent to the Analog Range.

The allowable range for CH1 is 5% minimum to 95% maximum for all response speeds.

For the Discrete Output CH2, the Offset Percent is used during the Window, Light, or Dark SET methods. The threshold(s) are positioned a programmable % offset from the taught condition.

The allowable range for CH2 is 2% minimum to 999% maximum (depending on the selected TEACH method) for all response speeds.

 The offset percent can also be programmed to **Minimum Offset**. This allows the DF-G3 to set the threshold(s) as close as possible to the presented condition, but still provide for reliable sensing.



Note: Offset Percent MUST be programmed to **Minimum Offset** for Dark SET to accept conditions of no signal (0 counts).

3.2.4 Analog Output Slope

The slope of the analog output can be configured as positive (analog value increases with increasing signal strength) or negative (analog value decreases with increasing signal strength).

3.2.5 Analog Output—Voltage Output Models Only

The analog output can be configured to range from 0 to 10 volts or 1 to 5 volts.

3.2.6 Filter Counts

Use this menu to set the number of readings that are averaged together before the analog output value updates. Increasing the Filter Counts decreases the amount of noise on the analog signal, but it increases the time constant of the analog output's response to a signal change. This time constant is a product of the selected Response Speed and the Filter Counts.

3.2.7 Input Wire Function

The DF-G3 can be programmed for one of the following input wire functions:

- Off—Ignore all pulses
- Set—Remote TEACH input
- Master—Master sync line output for multi-sensor cross-talk avoidance
- Slave—Slave sync line input for multi-sensor cross-talk avoidance
- LED off—When the input wire is active the emitter LED turns off
- LED on—When the input wire is active the emitter LED turns on
- Gate—When the input wire is active the outputs are locked in their present state; any active delay timers are paused

For remote programming in Set Mode see [Remote Input](#) on p. 12.

To configure sensors for master-slave operation, see [Sync Master/Slave](#) on p. 13.

3.2.8 Display Readout

The readout of the digital displays can be programmed for the following options:

³ Excess gain = 1 (high sensitivity), opposed mode sensing. PIT46U plastic fiber used for visible LED models.

⁴ Excess gain = 1 (high sensitivity), opposed mode sensing. IT.83.3ST5M6 glass fiber used for IR models.

- Signal/Threshold readout - Numeric (1234) or % (123P)
- ECO mode - Enabled or Disabled (ECO mode dims the displays to reduce current consumption)
- Display Orientation - Normal (1234) or Flipped (᠎ᠡ᠘᠘)

3.2.9 Gain Selection Gain SEL

The DF-G3 can operate in Auto Gain mode or the Gain can be fixed to be in Gain 1...7. In Auto Gain, the DF-G3 optimizes the gain during a TEACH/SET method for the presented condition(s). While viewing the fixed gains in the Gain Selection choice list, the DF-G3 will automatically switch to the selected gain and display the measured signal on the Red display. This allows for easy and quick evaluation of the fixed gain mode.

3.2.10 Factory Defaults Factory DEF

The Factory Defaults menu allows the DF-G3 to be easily restored back to original factory default settings (see **Factory Default Settings** in Specifications).

3.2.11 Output Selection Out SEL2

Only the discrete output, CH2, can be programmed for either light operate (LO) or dark operate (DO).

3.2.12 Auto Thresholds Auto THR1

Auto Thresholds can be programmed to be ON/OFF. The Auto Thresholds algorithm continuously tracks slow changes in the taught condition(s), and optimizes the threshold(s) to provide for reliable sensing. For Two-Point and Dynamic TEACH, the algorithm optimizes the threshold to be centered between the light and dark conditions. For Window, Light, and Dark SET, the algorithm optimizes the threshold(s) to maintain the programmed Offset Percent from the taught condition.

- After programming Auto Thresholds to ON, it is highly recommended to re-perform the TEACH/SET method
- Manual Adjustments are disabled when Auto Thresholds are ON
- Auto Thresholds are automatically disabled in Calibration SET (see [Calibration SET](#) on p. 22)
- Severe contamination/changes in the taught condition can prevent the Auto Thresholds algorithm from optimizing the threshold(s). If this occurs, the DF-G3 enters a **Threshold Alert** or **Threshold Error** state. See [Troubleshooting](#) on p. 23 for more explanation.

3.2.13 Delays/Timers OFF dLY2 OFF 1Sh2 On dLY2 On 1Sh2

ON/OFF Delays and ON/OFF One-Shot timers can be programmed (for CH2 only) between 1 - 9999 ms (a value of 0 disables the delay/timer). [Figure 2](#) on p. 11 defines how the delays/timers affect the output behavior.

Some combinations of delays/timers are not allowed. The DF-G3 programming menu automatically disables invalid combinations of delays/timers. The following table shows the allowable combinations of delays/timers:

Figure 2. DF-G3 Delays/Timers

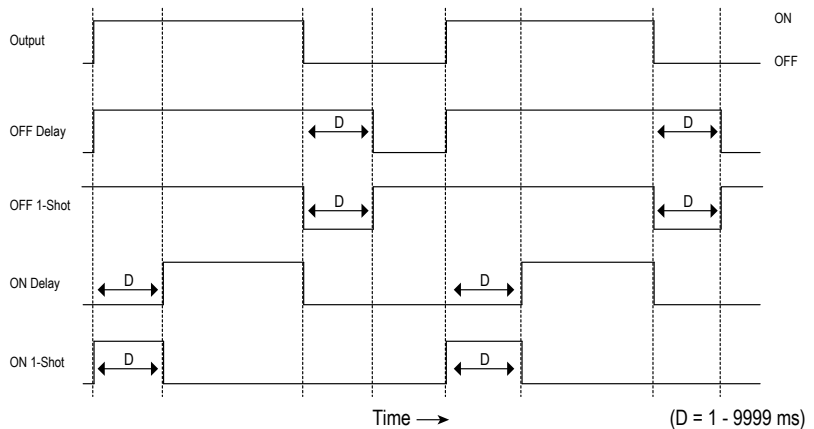

	OFF Delay	OFF One-Shot Timer	ON Delay	ON One-Shot Timer
OFF Delay	-	OK	OK	N/A
OFF One-Shot Timer	OK	-	N/A	N/A
ON Delay	OK	N/A	-	OK
ON One-Shot Timer	N/A	N/A	OK	-

3.2.14 Sensitivity Selection SEnS SEL2

The Sensitivity selection can be programmed for CH2. Use this setting to increase (lo) or decrease (high) the switch-point hysteresis from the default (std) setting.

- high—High sensitivity. Use this setting for low contrast sensing
- Std—Standard sensitivity
- Lo—Low sensitivity. Use this setting to stabilize the output in high vibration applications

3.3 Remote Input

Use the input wire to program the sensor remotely. To program the sensor using the input wire, remote input must be enabled (inPt SEL = SET, see [Input Wire Function](#) on p. 10). The remote input provides limited programming options (see the figure below). Pulse the remote input according to the figures and the instructions provided in this manual.



Note: For NPN models, the remote input pulses are active low as shown in the following figures. For PNP models, the remote input pulses are active high and are inverted from the following figures.

Figure 3. Remote Input Flowcart

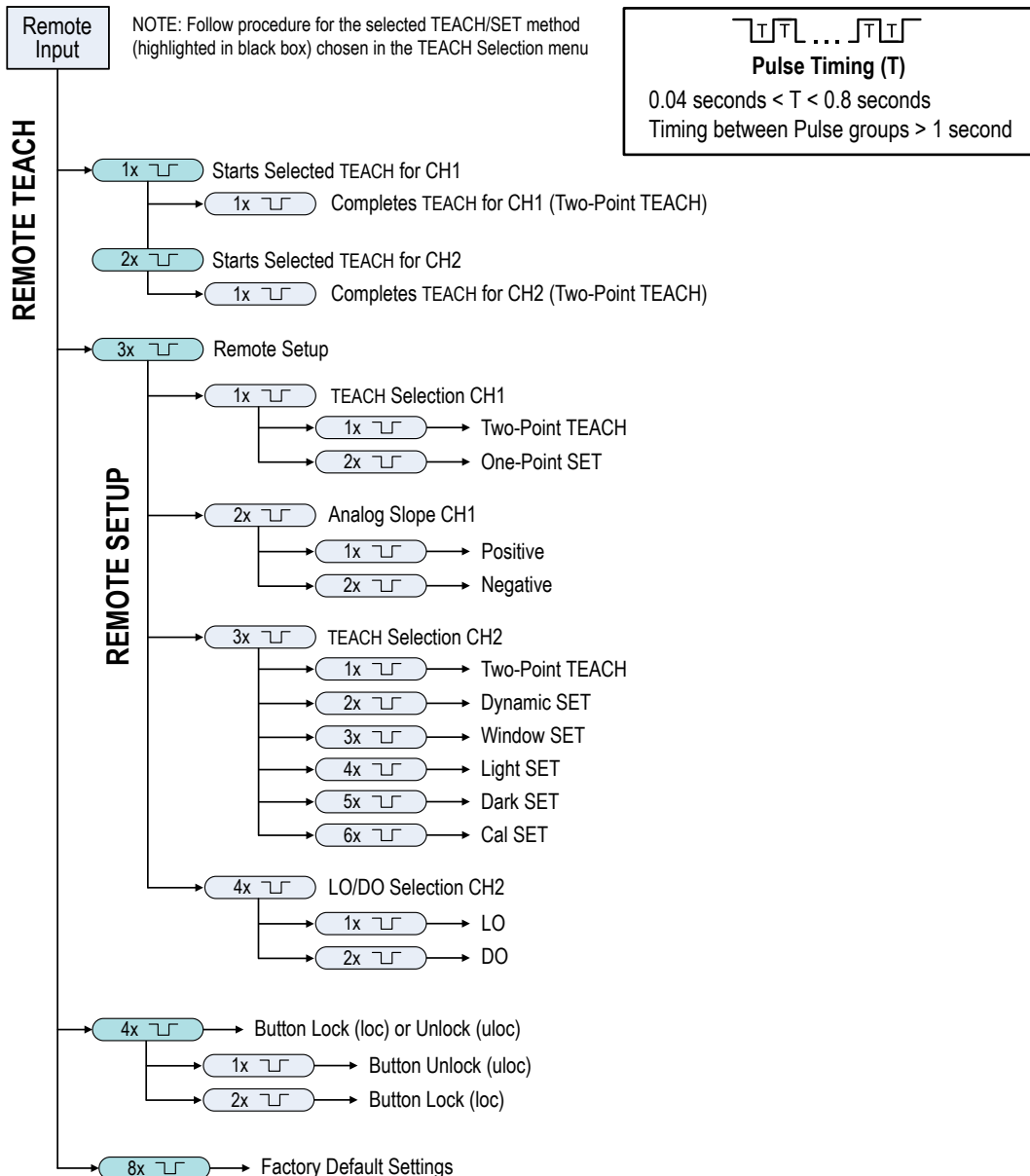

3.4 Sync Master/Slave

Up to seven DF_G3 Long Range expert Dual Display Fiber Amplifier with Analog Output sensors may be used together in a single sensing application. To eliminate crosstalk between the sensors, configure one sensor to be the master and the remaining sensors to be the slaves. In this mode, the sensors alternate taking measurements and the response speed is 2 ms.

Note: Note: In this mode, all sensors must either be NPN or PNP output models.

1. Configure the first sensor as the Master (inPt SEL = MAST).
2. In the Master sensor set-up, enter the total number of Slave sensors you will be using (tOtL SLAV = 1 - 6).
3. For each Slave sensor used, configure the input as a Slave (inPt SEL = SLVE).
4. Give each Slave its own identifying address (SLAV Addr = 1 - 6).
5. Connect the Input wires of the Master and all of the Slaves together.

Note: Note: Giving two Slave sensors the same address will cause them to fire their emitters at the same time in the firing sequence.



3.5 Adjust Mode

Sliding the RUN/PRG/ADJ mode switch to the ADJ position allows the user to perform Expert TEACH/SET methods and Manual Adjustment of the threshold and the midpoint or endpoints of the analog output depending on whether a 1-point SET or 2-point TEACH was used.

Note: For threshold and analog endpoints, when teaching CH2, the gain setting will be the same as the gain setting made during the CH1 teach. Reteaching CH1 may invalidate the previous CH2 teach.

3.5.1 CH1 Analog Output

Two-Point TEACH

- Establishes defined endpoints for the analog output range
- Analog endpoints can be adjusted by using the "+" and "-" rocker button (Manual Adjust)

Two-Point TEACH is used when two conditions can be presented statically to the sensor. The first taught condition is set to 0 V (4 mA), and the second taught condition to 10 V (20 mA). The order of the taught points determines the slope. If the first taught condition is darker, the slope will be positive. Reverse the slope of the analog output by changing the AOut SLPE menu setting.

Note: Depending on the application configuration and fibers used, the analog function may or may not behave linearly. The received light intensity will be dictated by the inverse square properties of light.

Figure 4. Two-Point TEACH (Light Operate shown)

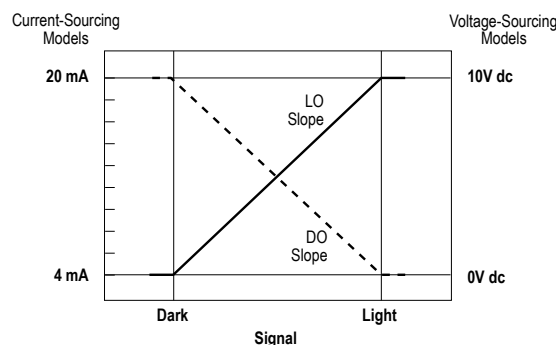

One-Point SET

- Defines the 5 V (12 mA) midpoint of the analog output
- Analog midpoint can be adjusted by using the "+" and "-" rocker button (Manual Adjust)

A single sensing condition is presented, and the sensor positions the midpoint of its analog range (5 V or 12 mA) exactly at the presented condition. The size of the window is determined by the OFSt Pct1 menu setting. The slope of the analog output is determined by the AOut SLPE setting.

Figure 5. One-Point SET (Light Operate shown)

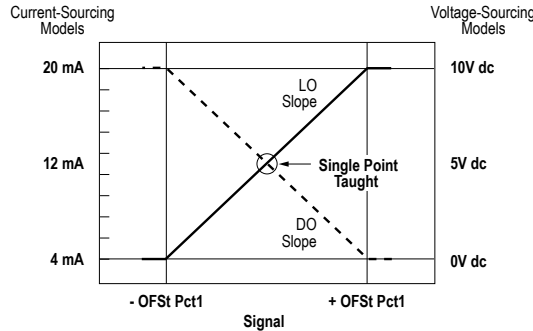

3.5.2 CH2 Discrete Output

Two-Point TEACH

- Establishes a single switching threshold
- Threshold can be adjusted by using the "+" and "-" rocker button (Manual Adjust)

Two-Point TEACH is used when two conditions can be presented statically to the sensor. The sensor locates a single sensing threshold (the switch point) midway between the two taught conditions, with the Output ON condition on one side, and the Output OFF condition on the other.

Figure 6. Two-Point TEACH (Light Operate shown)

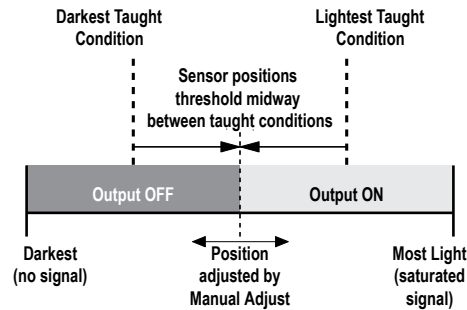

The Output ON and OFF conditions can be reversed by using the LO/DO (Light Operate/ Dark Operate) switch or through the program interface for the dual output model.

Two-Point TEACH and Manual Adjust

Moves switching threshold value up or down to make adjustments

- Slide Mode switch to ADJ to enter Adjust mode
- Press "+" to increase; press "-" to decrease
 - GREEN display shows the switching threshold value
 - 2 seconds after adjustment, the GREEN display will flash 3 times to confirm
- Slide Mode switch to RUN to complete operation





Remember: Manual adjustments are disabled when Auto Thresholds are ON

Follow these steps to perform a Two-Point TEACH:





Note: TEACH Selection must be programmed to **2Pt tch**.



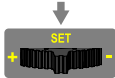

1. Enter Adjust mode.

Method	Action	Result
SET Button ⁵	Set the Mode switch to ADJ. 	Display: Red - Signal Level; Green - Threshold 
Remote Input ⁶	No action is required; sensor is ready for the Two-Point TEACH method	



2. Teach the first condition.

Method	Action	Result
SET Button	a. Present the first condition. b. Click the SET rocker button. 	Display: Flashes "2Pt tch" then holds on "1234 2nd" 
Remote Input	a. Present the first condition. b. Single-pulse the remote input. 	

3. Teach the second condition.

Method	Action	Result
SET Button	a. Present the second condition. b. Click the SET rocker button. 	TEACH Accepted Displays alternate "PASS" and % Minimum Difference ⁷ ; Sensor returns to Adjust mode 
Remote Input	a. Present the second condition. b. Single-pulse the remote input. 	TEACH Not Accepted Displays alternate "FAIL" and % Minimum Difference ⁷ ; Sensor returns to Adjust mode 

4. Return to Run mode.

Method	Action	Result
SET Button	Move the Mode switch to RUN 	Display: Red - Signal Level; Green - Threshold 
Remote Input	No action is required; sensor returns to RUN mode automatically	

Dynamic TEACH

- Teaches on-the-fly
- Establishes a single switching threshold
- Threshold can be adjusted using "+" and "-" rocker button (Manual Adjust)

Dynamic TEACH is best used when a machine or process may not be stopped for teaching. The sensor learns during actual sensing conditions, taking multiple samples of the light and dark conditions and automatically setting the threshold at the optimum level.

⁵ SET Button: 0.04 seconds ≤ "Click" ≤ 0.8 seconds

⁶ Remote Input: 0.04 seconds ≤ T ≤ 0.8 seconds

⁷ See [Troubleshooting](#) on p. 23 for more explanation of the % Minimum Difference displayed after the Two-Point TEACH method.

Figure 7. Dynamic TEACH (Light Operate shown)

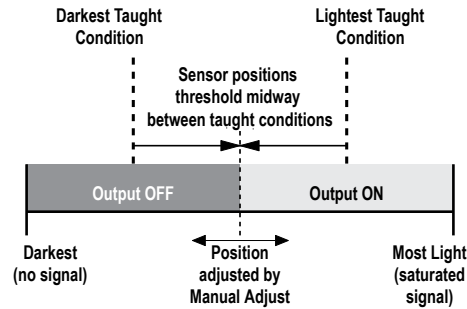

Reverse the CH2 Output ON and OFF conditions by using the LO/DO (Light Operate/ Dark Operate) selection through the program interface.

Dynamic TEACH and Manual Adjust

Moves switching threshold value up or down to make adjustments

- Slide Mode switch to ADJ to enter Adjust mode
- Press "+" to increase; press "-" to decrease
 - GREEN display shows the switching threshold value
 - 2 seconds after adjustment, GREEN display will flash 3 times to confirm
- Slide Mode switch to RUN to complete operation



Remember: Manual adjustments are disabled when Auto Thresholds are ON

Follow these steps to perform **Dynamic TEACH**:



Note: TEACH Selection must be programmed to **dYn tch**.

1. Enter Adjust Mode.

Method	Action	Result
SET Button ⁸	Set Mode switch to ADJ	Display: Red - Signal Level; Green - Threshold
Remote Input ⁹	No action required; sensor is ready for Dynamic TEACH method	

2. Enter Dynamic TEACH.

Method	Action	Result
SET Button	Click the SET rocker button	Display: Flashes "dYn tch" then holds on "1234 dYn"
Remote Input	Single-pulse remote input	

3. Present ON and OFF Conditions.



Method	Action	Result
SET Button	Present ON and OFF conditions	Display: Red - Signal Level; Green - Threshold

⁸ SET Button: 0.04 seconds ≤ "Click" ≤ 0.8 seconds

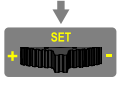

⁹ Remote Input: 0.04 seconds ≤ T ≤ 0.8 seconds

Method	Action	Result
Remote Input	Present ON and OFF conditions	

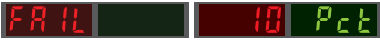
4. Exit Dynamic TEACH.

Method	Action	Result
SET Button	Click the SET rocker button 	TEACH Accepted Displays alternate "PASS" with % Minimum Difference ¹⁰ , Sensor returns to Adjust mode 
Remote Input	Single-pulse remote input 	TEACH Not Accepted Displays alternate "FAIL" with % Minimum Difference ¹⁰ , Sensor returns to Adjust mode 

5. Return to RUN Mode.

Method	Action	Result
SET Button	Move Mode switch to RUN 	Display: Red - Signal Level; Green - Threshold 
Remote Input	No action required; sensor returns to RUN mode automatically	

Window SET

- Sets window thresholds that extend a programmable % offset above and below the presented condition
- All other conditions (lighter or darker) cause the output to change state
- Sensing window center can be adjusted using "+" and "-" rocker button (Manual Adjust)
- Recommended for applications where a product may not always appear in the same place, or when other signals may appear
- See Program Mode for programming the Offset Percent setting

A single sensing condition is presented, and the sensor positions window thresholds a programmable % offset above and below the presented condition. In LO mode, Window SET designates a sensing window with the Output ON condition inside the window, and the Output OFF conditions outside the window.

Figure 8. Window SET (Light Operate shown)

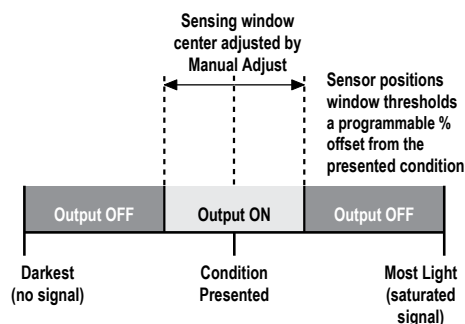

Reverse the Output ON and OFF conditions by using the LO/DO (Light Operate/ Dark Operate) selection through the program interface for the dual output model.

¹⁰ See [Troubleshooting](#) on p. 23 for more explanation of the % Minimum Difference displayed after the Dynamic TEACH method.

Window SET and Manual Adjust

Moves sensing window center value up or down to make adjustments

- Slide Mode switch to ADJ to enter Adjust mode
- Press "+" to increase; press "-" to decrease
 - GREEN display shows the sensing window center value
 - 2 seconds after adjustment, the GREEN display will flash 3 times to confirm
- Slide Mode switch to RUN to complete operation





Remember: Manual adjustments are disabled when Auto Thresholds are ON

Follow these steps to perform a Window SET:





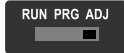

Note: TEACH Selection must be programmed to **wind SET**.

1. Enter Adjust Mode

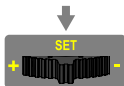
Method	Action	Result
SET Button ¹¹	Set Mode switch to ADJ 	Display: Red - Signal Level; Green - Threshold 
Remote Input ¹²	No action required; sensor is ready for Window SET method	

2. SET Sensing Condition

Method	Action	Result
SET Button	<ul style="list-style-type: none"> • Present sensing condition • Click the SET rocker button  	<p>Threshold Condition Accepted Displays read "wInd SET" then alternate "PASS" with % Offset ¹³; Sensor returns to Adjust mode</p> 
Remote Input	<ul style="list-style-type: none"> • Present sensing condition • Single-pulse the remote input  	<p>Threshold Condition Not Accepted Displays read "wInd SET" then alternate "FAIL" with minimum % Offset ¹³ for sensing condition; Sensor returns to Adjust mode</p> 

3. Return to RUN Mode

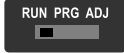
Method	Action	Result
SET Button	Move Mode switch to Run 	Display: Red - Signal Level; Green - Window Center (see Figure 9 on p. 19 for instructions on how to display upper and lower thresholds)
Remote Input	No action required; sensor returns to Run mode automatically	

¹¹ SET Button: 0.04 seconds ≤ "Click" ≤ 0.8 seconds

¹² Remote Input: 0.04 seconds ≤ T ≤ 0.8 seconds

¹³ See [Troubleshooting](#) on p. 23 for more explanation of the % Offset displayed after the Window SET method

Figure 9. Upper and Lower Thresholds

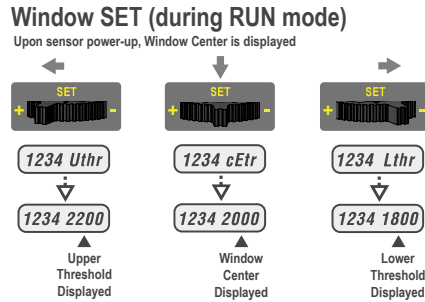

Light SET

- Sets a threshold a programmable % offset below the presented condition
- Changes output state on any condition darker than the threshold condition
- Threshold can be adjusted using "+" and "-" rocker button (Manual Adjust)
- Recommended for applications where only one condition is known, for example a stable light background with varying darker targets
- See Program Mode for programming the Offset Percent setting

A single sensing condition is presented, and the sensor positions a threshold a programmable % offset below the presented condition. When a condition darker than the threshold is sensed, the output either turns ON or OFF, depending on the LO/DO setting.

Figure 10. Light SET (Light Operate shown)

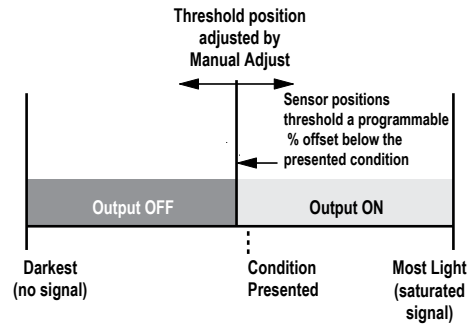

Light SET and Manual Adjust

Moves switching threshold value up or down to make adjustments

- Slide Mode switch to ADJ to enter Adjust mode
- Press "+" to increase; press "-" to decrease
 - GREEN display shows the switching threshold value
 - 2 seconds after adjustment, the GREEN display will flash 3 times to confirm
- Slide Mode switch to RUN to complete operation





Remember: Manual adjustments are disabled when Auto Thresholds are ON

Follow these steps to perform a Light SET:





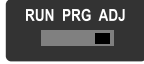

Note: TEACH Selection must be programmed to **Lt SET**.

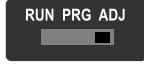

1. Enter Adjust Mode

Method	Action	Result
SET Button ¹⁴	Set Mode switch to ADJ 	Display: Red - Signal Level; Green - Threshold 
Remote Input ¹⁵	No action is required; sensor is ready for Light SET method	

2. SET Sensing Condition

Method	Action	Result
SET Button	<ul style="list-style-type: none"> Present sensing condition Click the SET rocker button 	<p>Threshold Condition Accepted Displays read "Lt SET" then alternate "PASS" with % Offset ¹⁶; Sensor returns to Adjust mode</p> 
Remote Input	<ul style="list-style-type: none"> Present sensing condition Single-pulse the remote input 	<p>Threshold Condition Not Accepted Displays read "Lt SET" then alternate "FAIL" with minimum % Offset ¹⁶ for sensing condition; Sensor returns to Adjust mode</p> 

3. Return to RUN Mode

Method	Action	Result
SET Button	Move Mode switch to RUN 	Display: Red - Signal Level; Green - Threshold 
Remote Input	No action required; sensor returns to RUN mode automatically	

Dark SET

- Sets a threshold a programmable % offset above the presented condition
- Any condition lighter than the threshold condition causes the output to change state
- Threshold can be adjusted using "+" and "-" rocker button (Manual Adjust)
- Recommended for applications where only one condition is known, for example a stable dark background with varying lighter targets
- See Program Mode for programming the Offset Percent setting



Note: Offset Percent MUST be programmed to **Minimum Offset** to accept conditions of no signal (0 counts).

A single sensing condition is presented, and the sensor positions a threshold a programmable % offset above the presented condition. When a condition lighter than the threshold is sensed, the output either turns ON or OFF, depending on the LO/DO setting.

¹⁴ SET Button: 0.04 seconds ≤ "Click" ≤ 0.8 seconds

¹⁵ Remote Input: 0.04 seconds ≤ T ≤ 0.8 seconds

¹⁶ See [Troubleshooting](#) on p. 23 for more explanation of the % Offset displayed after the Light SET method

Figure 11. Dark SET (Light Operate shown)

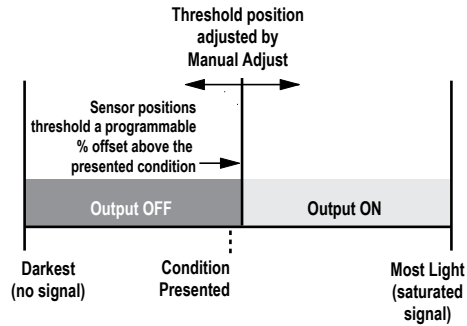

Dark SET and Manual Adjust

Moves switching threshold value up or down to make adjustments

- Slide Mode switch to ADJ to enter Adjust mode
- Press "+" to increase; press "-" to decrease
 - GREEN display shows the switching threshold value
 - 2 seconds after adjustment, the GREEN display will flash 3 times to confirm
- Slide Mode switch to RUN to complete operation





Remember: Manual adjustments are disabled when Auto Thresholds are ON

Follow these steps to perform a Dark SET:





Note: TEACH Selection must be programmed to **dr SET**.

1. Enter Adjust Mode.

Method	Action	Result
SET Button ¹⁷	Set Mode switch to ADJ 	Display: Red - Signal Level; Green - Threshold 
Remote Input ¹⁸	No action required; sensor is ready for Dark SET method	

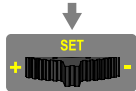
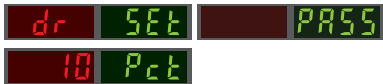
2. SET Sensing Condition.

Method	Action	Result
SET Button	<ul style="list-style-type: none"> • Present sensing condition • Click the SET rocker button 	<p>Threshold Condition Accepted Displays read "dr SET" then alternate "PASS" with % Offset ¹⁹; Sensor returns to Adjust mode</p> 
Remote Input	<ul style="list-style-type: none"> • Present sensing condition • Single-pulse the remote input 	<p>Threshold Condition Not Accepted Displays read "dr SET" then alternate "FAIL" with minimum % Offset ¹⁹ for sensing condition; Sensor returns to Adjust mode</p> 

¹⁷ SET Button: 0.04 seconds ≤ "Click" ≤ 0.8 seconds

¹⁸ Remote Input: 0.04 seconds ≤ T ≤ 0.8 seconds

¹⁹ See [Troubleshooting](#) on p. 23 for more explanation of the % Offset displayed after the Dark SET method

3. Return to RUN Mode.

Method	Action	Result
SET Button	Move Mode switch to RUN 	Display: Red - Signal Level; Green - Threshold 
Remote Input	No action required; sensor returns to RUN mode automatically	

Calibration SET

- Sets a threshold exactly at the presented condition
- Threshold can be adjusted using "+" and "-" rocker button (Manual Adjust)

A single sensing condition is presented, and the sensor positions a threshold exactly at the presented condition. When a condition lighter than the threshold is sensed, the output either turns ON or OFF, depending on the LO/DO setting.

Figure 12. Calibration SET (Light Operate shown)

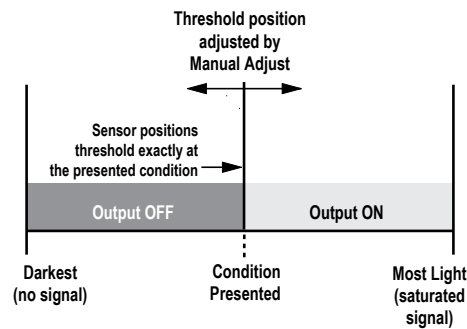

Calibration SET and Manual Adjust

Moves switching threshold value up or down to make adjustments

- Slide Mode switch to ADJ to enter Adjust mode
- Press "+" to increase; press "-" to decrease
 - GREEN display shows the switching threshold value
 - 2 seconds after adjustment, the GREEN display will flash 3 times to confirm
- Slide Mode switch to RUN to complete operation





Remember: Auto Thresholding is automatically disabled in Calibration SET

Follow these steps to perform a Calibration SET:



Note: TEACH Selection must be programmed to **CAL SET**.





1. Enter Adjust Mode

Method	Action	Result
SET Button ²⁰	• Set Mode switch to ADJ 	Display: Red - Signal Level; Green - Threshold 
Remote Input ²¹	No action required; sensor is ready for Calibration SET method	

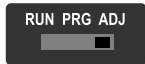

2. SET Sensing Condition

²⁰ SET Button: 0.04 seconds ≤ "Click" ≤ 0.8 seconds

²¹ Remote Input: 0.04 seconds ≤ T ≤ 0.8 seconds

Method	Action	Result
SET Button	<ul style="list-style-type: none"> Present sensing condition Click the SET rocker button 	Threshold Condition Accepted Displays read "cAL SET" then flashes "PASS"; Sensor returns to Adjust mode 
Remote Input	<ul style="list-style-type: none"> Present sensing condition Single-pulse the remote input 	Threshold Condition Unacceptable Displays read "cAL SET" then flashes "FAIL"; Sensor returns to Adjust mode 

3. Return to RUN Mode

Method	Action	Result
SET Button	Move Mode switch to RUN 	Display: Red - Signal Level; Green - Threshold 
Remote Input	No action required; sensor returns to RUN mode automatically	

3.6 Troubleshooting

3.6.1 Manual Adjustments Disabled

Manual adjustments are disabled when Auto Thresholds are ON. If a manual adjustment is attempted while Auto Thresholds are ON, the Green display will flash .

3.6.2 Percent Minimum Difference after TEACH

The Two-Point and Dynamic TEACH methods will flash a % minimum difference on the displays after a PASS or FAIL.

Value	PASS/FAIL	Description
0 to 99%	FAIL	The difference of the taught conditions does not meet the required minimum
100 to 300%	PASS	The difference of the taught conditions just meets/exceeds the required minimum, minor sensing variables may affect sensing reliability
300 to 600%	PASS	The difference of the taught conditions sufficiently exceeds the required minimum, minor sensing variables will not affect sensing reliability
600% +	PASS	The difference of the taught conditions greatly exceeds the required minimum, very stable operation



3.6.3 Percent Offset after SET

The Window, Dark, and Light SET methods will flash a % offset on the displays after a PASS or FAIL.

SET Result	% Offset Meaning
PASS (with % Offset)	Displays the % offset used for the SET method
FAIL (with % Offset)	Displays the minimum required % offset necessary to PASS the SET method
FAIL (without % Offset)	Presented condition cannot be used for the SET method

3.6.4 Threshold Alert or Threshold Error

Severe contamination/changes in the taught condition can prevent the Auto Thresholds algorithm from optimizing the threshold(s).

State	Display	Description	Corrective Action
Threshold Alert	Alternates  and 	The threshold(s) cannot be optimized, but the sensor's output will still continue to function	Cleaning/correcting the sensing environment and/or a re-teach of the sensor is highly recommended
Threshold Error		The threshold(s) cannot be optimized, and the sensor's output will stop functioning	Cleaning/correcting the sensing environment and/or a re-teach of the sensor is required

4 Specifications

Sensing Beam

DF-G3: Visible red, 635 nm
 DF-G3IR: Infrared, 850 nm
 DF-G3LIR: Long infrared, 1450 nm

Supply Voltage

Voltage output models: 12 V DC to 30 V DC Class 2 (10% maximum ripple)
Current output models: 10 V DC to 30 V DC Class 2 (10% maximum ripple)

Power and Current Consumption (exclusive of load)

Standard display mode: 840 mW, Current consumption < 35 mA at 24 V DC
ECO display mode: 672 mW, Current consumption < 28 mA at 24 V DC

Supply Protection Circuitry

Protected against reverse polarity, overvoltage, and transient voltages

Delay at Power-Up

500 milliseconds maximum; outputs do not conduct during this time

Output Configuration

Voltage Output Models: 1 analog voltage output (user configurable as 1 V to 5 V or 0 V to 10 V) with 1 NPN or 1 PNP discrete output, depending on model.

Current Output Models: 1 analog current output (4 mA to 20 mA) with 1 NPN or 1 PNP discrete output, depending on model

Discrete Output Rating

100 mA maximum combined load—analogue plus discrete outputs (derate 1 mA per °C above 30 °C)

OFF-state leakage current: < 5 µA at 30 V DC

ON-state saturation voltage: NPN: < 1.5 V; PNP: < 2 V

Analog Output Recovery Time

< 2 times the selected response speed

Analog Output Ripple Content (p-p)

< 0.5% of the full scale analog output

Analog Output Rating

Voltage Outputs: 2.5 kOhm minimum load resistance

Current Outputs: 1 kOhm maximum load resistance at 24 V; maximum load resistance = $[(V_{cc} - 4)/.02]$ Ohms

Output Protection

Protected against output short-circuit, continuous overload, transient overvoltages, and false pulse on power-up

Response Speed and Features

Description	Response Speed	Repetition Period	Repeatability	Cross-Talk Avoidance	Energy Efficient Light Resistance	Maximum Range, Red ²²	Maximum Range, IR850 ²³
High Speed	500 µs	100 µs	100 µs	No	No	1200 mm	2400 mm
Fast	1000 µs	100 µs	150 µs	Yes	No	1500 mm	3000 mm
Standard	2 ms	100 µs	180 µs	Yes	Yes	1500 mm	3000 mm
Long Range	8 ms	100 µs	180 µs	Yes	Yes	1950 mm	3900 mm
Extra Long Range	24 ms	100 µs	180 µs	Yes	Yes	3000 mm	6000 mm

Indicators

Red 4-digit Display: Signal Level

Green 4-digit Display: Threshold

(In Program Mode, Red and Green displays are used for programming menus)

Yellow LED: Output conducting

Operating Conditions

Temperature: -10 °C to +55 °C (+14 °F to +131 °F)

Storage Temperature: -20 °C to +85 °C (-4 °F to +185 °F)

Humidity: 50% at +50 °C maximum relative humidity (non-condensing)

Environmental Rating

IP50, NEMA 1

Connections

PVC-jacketed 2 m or 9 m (6.5 ft or 30 ft) 5-wire integral cable; or integral 5-pin M8 quick disconnect; or 150 mm (6 in) cable with a 5-pin M8 quick disconnect

For Q3 or Q7 models, either a 5-pin M8 or a 6-pin M8 mating cordset may be used

Construction

Black ABS/polycarbonate alloy (UL94 V-0 rated) housing, clear polycarbonate cover

²² Excess gain = 1 (high sensitivity), opposed mode sensing. PIT46U plastic fiber used for visible LED models.

²³ Excess gain = 1 (high sensitivity), opposed mode sensing. IT.83.3ST5M6 glass fiber used for IR models.

Adjustments

- 3-way RUN/PRG/ADJ Mode Switch
- 2-way CH1/CH2 Switch
- 3-way +/SET/- Rocker Button
 - Expert-style teaching (Two-Point and Dynamic TEACH, Light/Dark/Window/Calibration SET)
 - Manually adjust sensitivity (from "+" and "-" rocker button only)
 - Output Selection, TEACH Selection, Response Speed, Offset Percent, Auto Thresholds, Delays/Timers, Sensitivity Selection, Input Selection, Display Readout, Gain Selection, Factory Defaults (from top panel)
 - Top panel interface lockout (from remote input only)

Factory Default Settings:

Setting	Factory Default
Output (CH2 only)	LO
Threshold	5024
TEACH Selection	Two-Point TEACH
Output Response Time	Standard: 2 ms
Offset Percent	10%
Analog Output Slope (CH1 only)	Positive
Analog Output Range (CH1, Voltage models only)	0 V to 10 V
Filter Counts (CH1 only)	1
Input Wire selection	Off
Display Readout	Numeric, ECO disabled, Normal Orientation
Gain Selection	Auto Gain
Auto Threshold (CH2 only)	Off
Output Delay Selection (CH2 only)	Off
Sensitivity Selection (CH2 only)	Standard

Required Overcurrent Protection



WARNING: Electrical connections must be made by qualified personnel in accordance with local and national electrical codes and regulations.

Overcurrent protection is required to be provided by end product application per the supplied table. Overcurrent protection may be provided with external fusing or via Current Limiting, Class 2 Power Supply. Supply wiring leads < 24 AWG shall not be spliced. For additional product support, go to www.bannerengineering.com.

Supply Wiring (AWG)	Required Overcurrent Protection (Amps)
20	5.0
22	3.0
24	2.0
26	1.0
28	0.8
30	0.5

Certifications



4.1 Excess Gain Curves

Figure 13. Diffuse—PBT16U

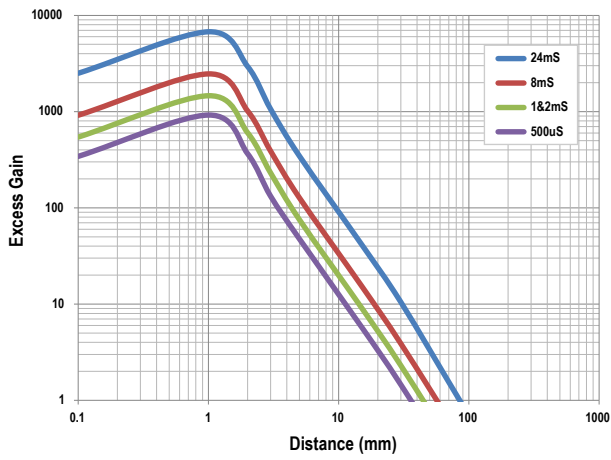

Figure 14. Diffuse—PBT26U

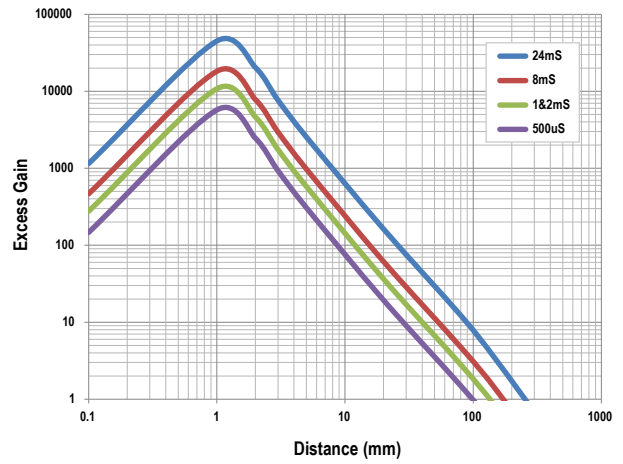

Figure 15. Diffuse—PBT46U

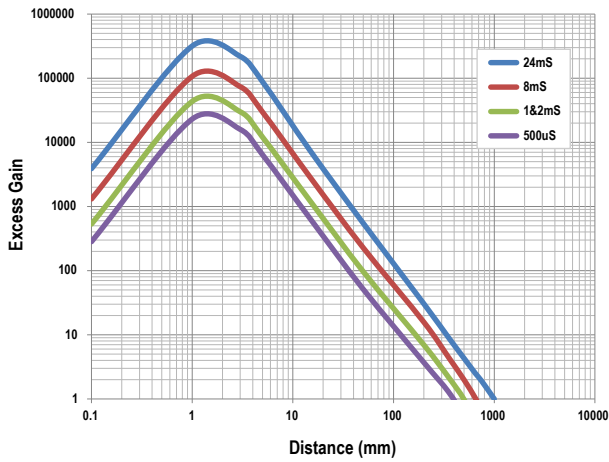

Figure 16. Diffuse—PBT66U

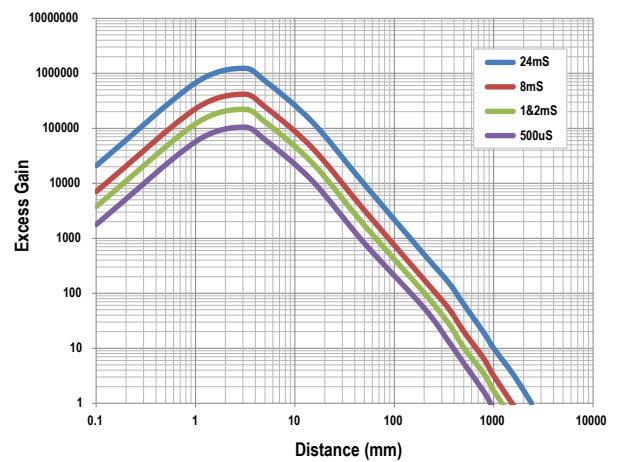

Figure 17. Opposed Mode—PIT16U

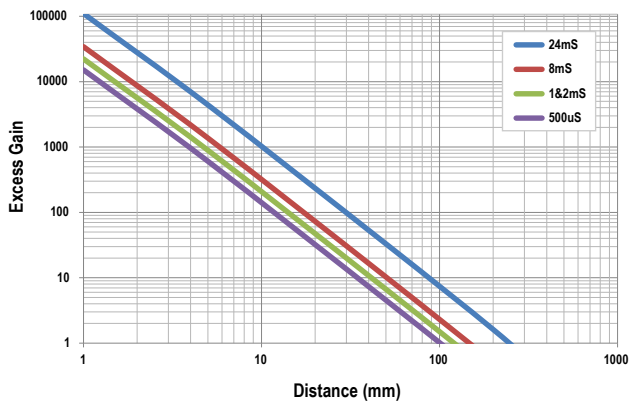

Figure 18. Opposed Mode—PIT26U

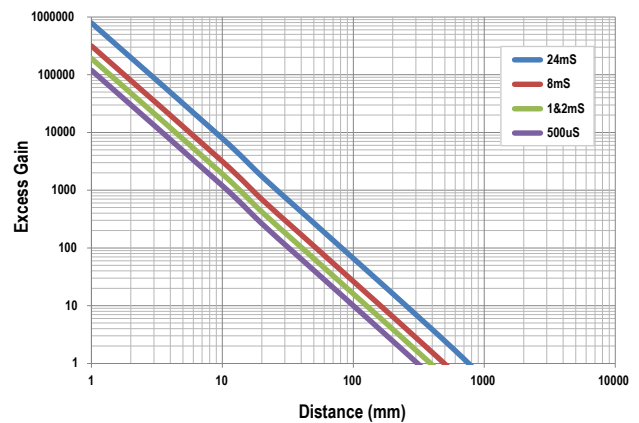

Figure 19. Opposed Mode—PIT46U

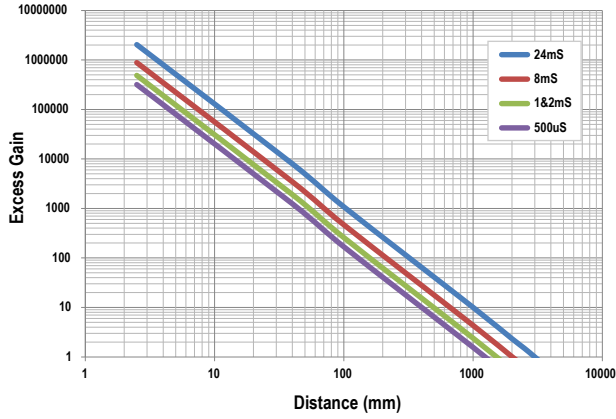
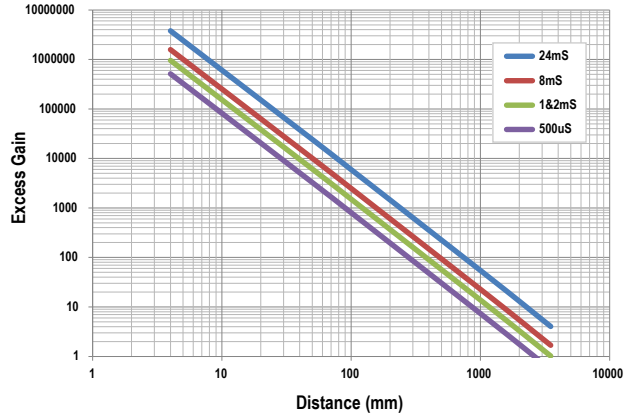
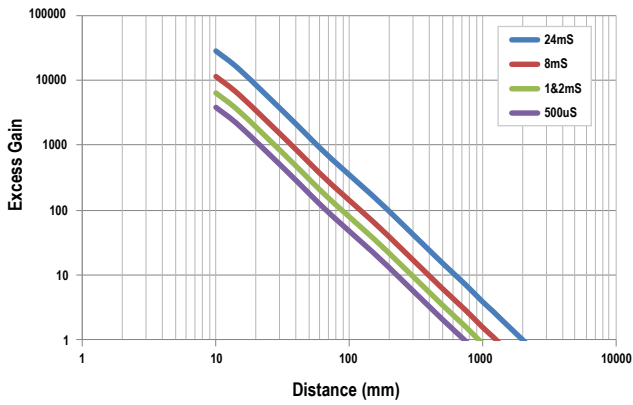

Figure 20. Opposed Mode—PIT66U



Note: The length of the fiber optics limits the range for the 8 and 24 ms response speeds.

Figure 21. Diffuse—IR850



Note: BTC1.13.4ST5M6 glass fiber used for diffuse mode

Figure 22. Opposed Mode—IR850

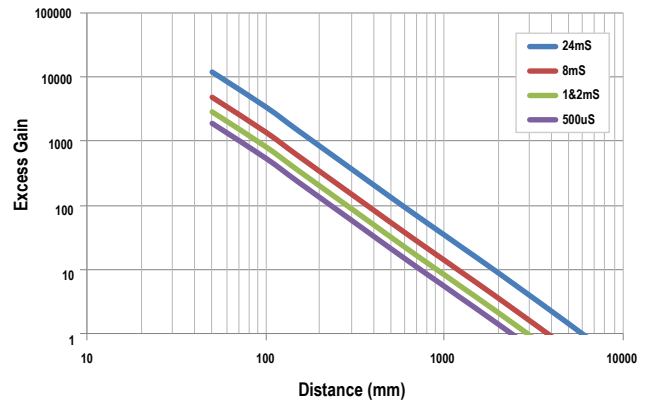

Note: IT.83.3ST5M6 glass fiber used for opposed mode

Figure 23. Diffuse—LIR1450

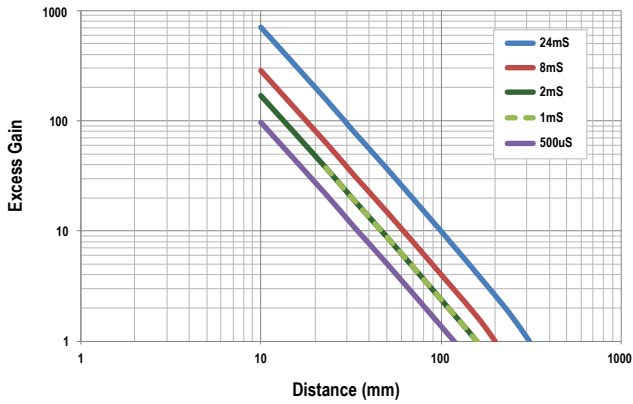
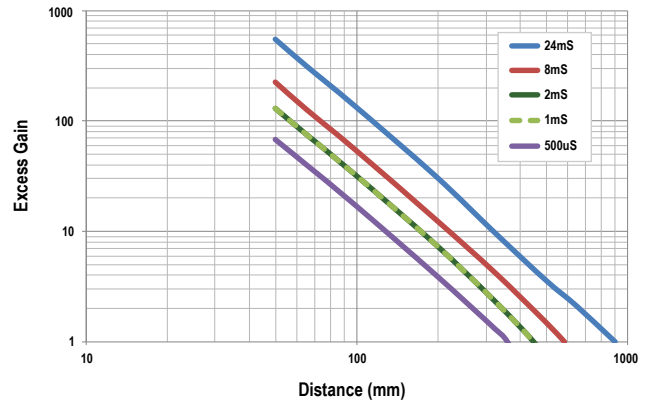

Figure 24. Opposed Mode—LIR1450



4.2 Beam Patterns

Figure 25. Diffuse—PBT16U

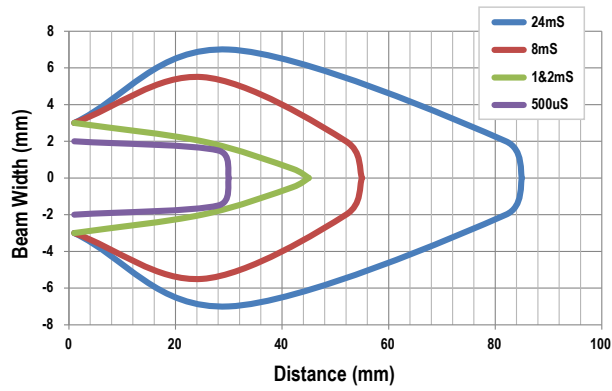

Figure 26. Diffuse—PBT26U

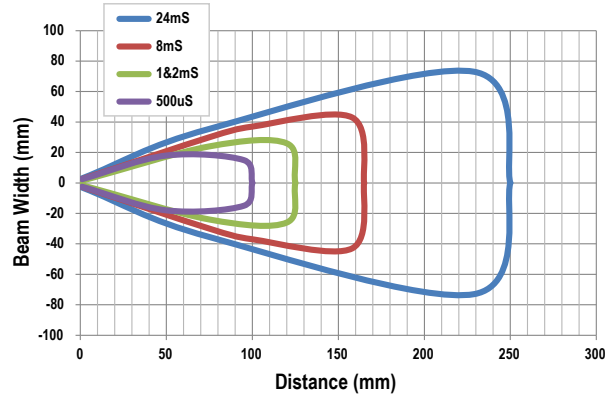

Figure 27. Diffuse—PBT46U

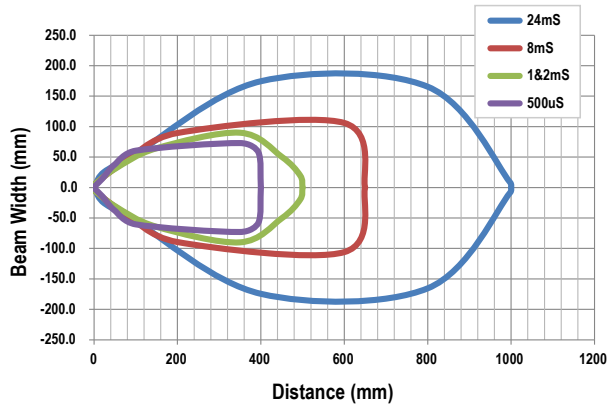

Figure 28. Diffuse—PBT66U

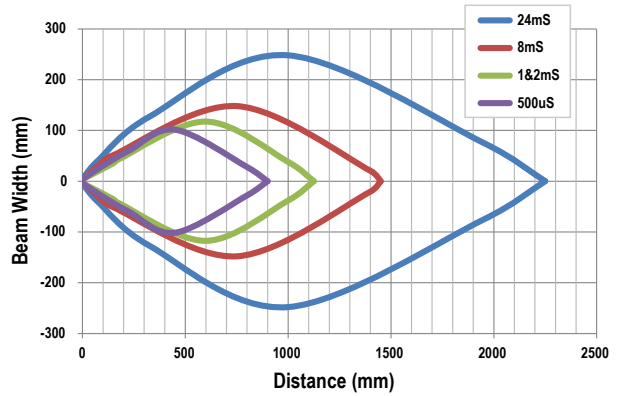

Figure 29. Opposed Mode—PIT16U

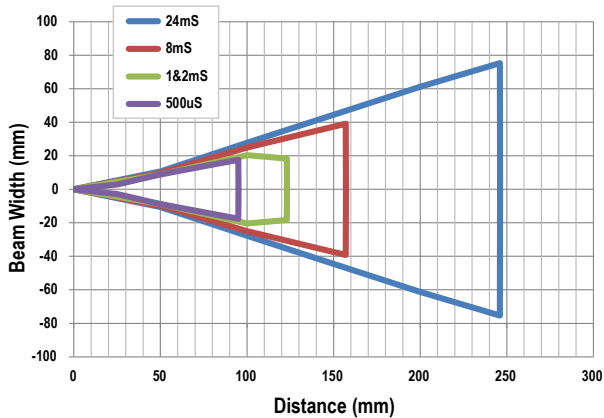

Figure 30. Opposed Mode—PIT26U

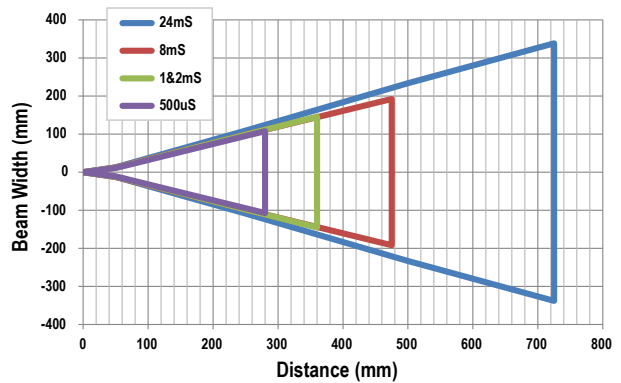

Figure 31. Opposed Mode—PIT46U

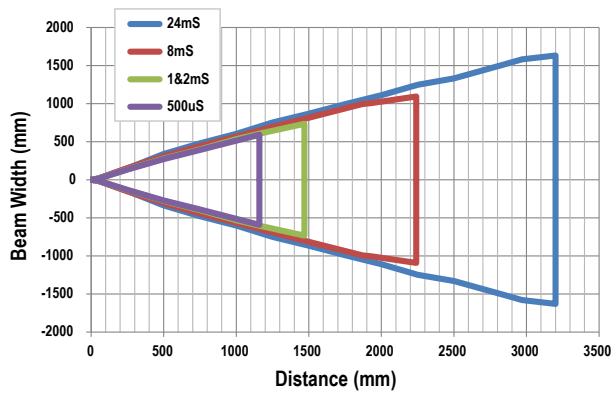

Figure 32. Opposed Mode—PIT66U

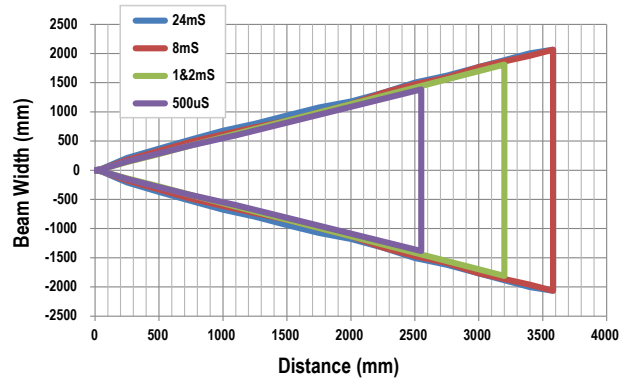

Figure 33. Diffuse—IR850

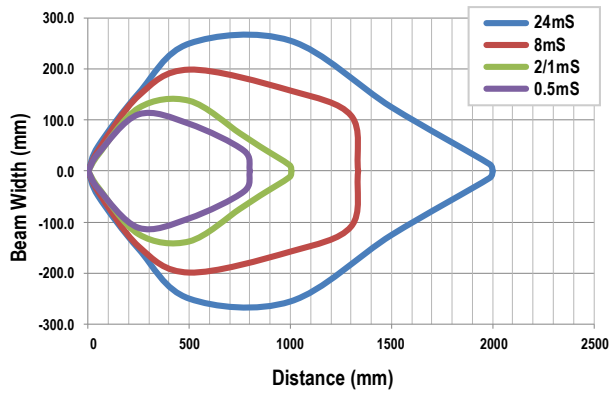
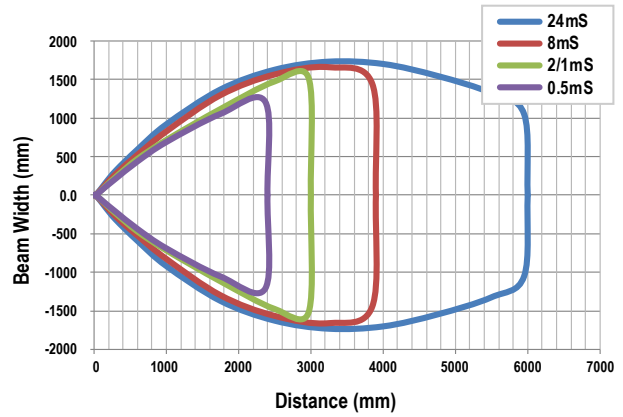

Figure 34. Opposed Mode—IR850



Note: BTC1.13.4ST5M6 glass fiber used for diffuse mode



Note: IT.83.3ST5M6 glass fiber used for opposed mode

Figure 35. Diffuse—LIR1450

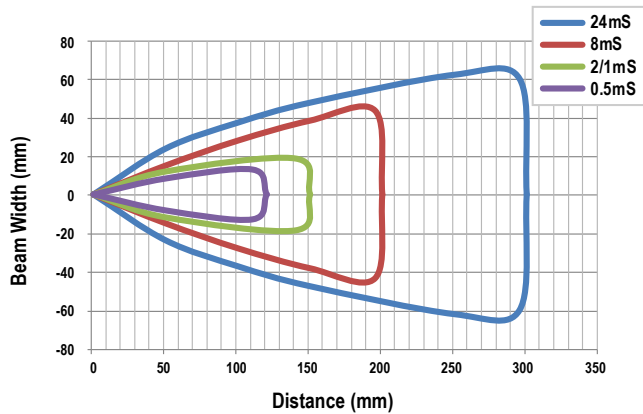
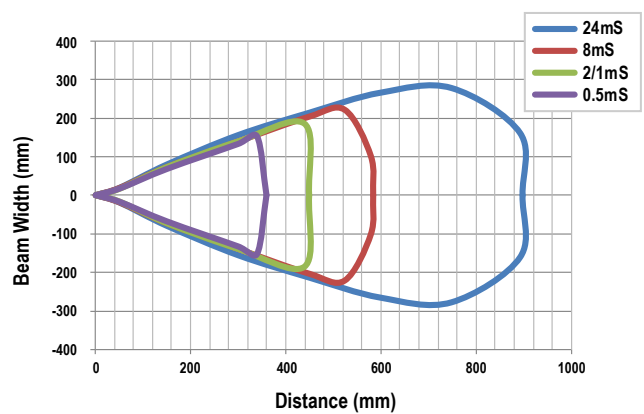
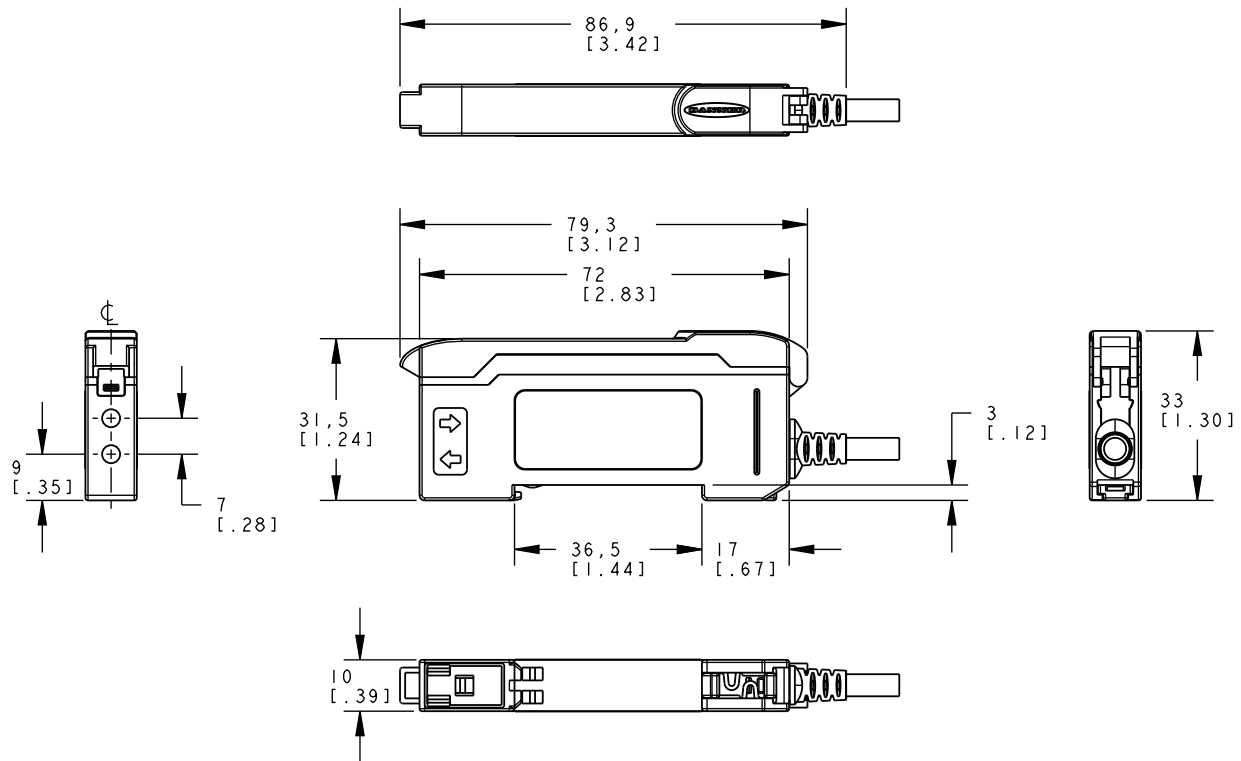

Figure 36. Opposed Mode—LIR1450



4.3 Dimensions



5 Accessories

DIN-35-..

35 mm DIN Rail

Model	Length
DIN-35-70	70
DIN-35-105	105
DIN-35-140	140
DIN-35-180	180
DIN-35-220	220

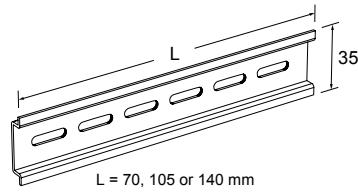

Hole center spacing: 35.1
Hole size: 25.4 x 5.3

SA-DIN-CLAMP

- Pair of metal DIN rail end stops; slide onto DIN rail at either side of the sensor stack
- Combination (#2 Phillips, #8 standard slotted) set screw

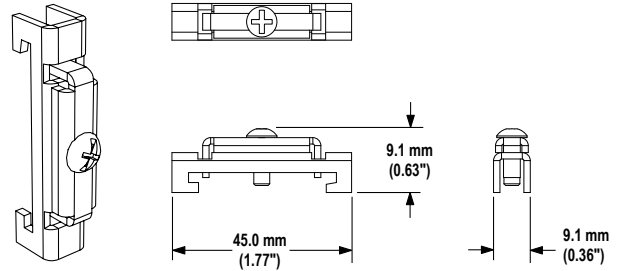

SA-DIN-BRACKET

- Plastic bracket with mounting screws

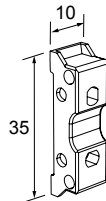

Hole center spacing: A = 16, B = 25.4, C = 15.2
Hole size: A = \varnothing 3.2, B = \varnothing 3.3, C = \varnothing 4.4

SA-DIN-BRACKET-10

- Package of 10 plastic brackets with mounting screws

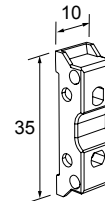

Hole center spacing: A = 16, B = 25.4, C = 15.2
Hole size: A = \varnothing 3.2, B = \varnothing 3.3, C = \varnothing 4.4

5.1 Quick-Disconnect Cordsets

5-Pin Threaded M12 Cordsets—Single Ended				
Model	Length	Style	Dimensions	Pinout (Female)
MQDC1-501.5	0.5 m (1.5 ft)	Straight		<p>1 = Brown 2 = White 3 = Blue 4 = Black 5 = Gray</p>
MQDC1-506	2 m (6.5 ft)			
MQDC1-515	5 m (16.4 ft)			
MQDC1-530	9 m (29.5 ft)			
MQDC1-506RA	2 m (6.5 ft)	Right-Angle		
MQDC1-515RA	5 m (16.4 ft)			
MQDC1-530RA	9 m (29.5 ft)			

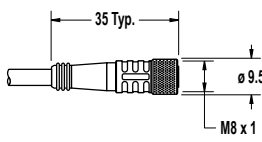
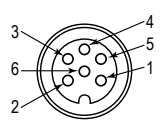
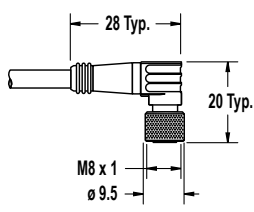
5-Pin Threaded M8 Cordsets—Single Ended				
Model	Length	Style	Dimensions	Pinout (Female)
PKG5M-2	2 m (6.56 ft)	Straight		 <p>1 = Brown 2 = White 3 = Blue 4 = Black 5 = Gray 6 = N.C.</p>
PKG5M-5	5 m (16.4 ft)			
PKG5M-9	9 m (29.5 ft)			
PKW5M-2	2 m (6.56 ft)	Right Angle		
PKW5M-5	5 m (16.4 ft)			
PKW5M-9	9 m (29.5 ft)			

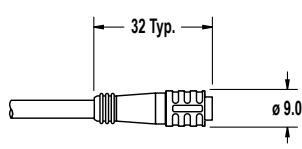
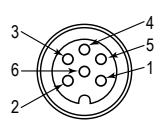
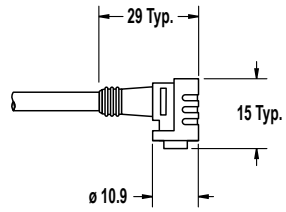
6-Pin Snap-on M8 Cordsets—Single Ended				
Model	Length	Style	Dimensions	Pinout (Female)
PKG6Z-2	2 m (6.56 ft)	Straight		 <p>1 - brown 2 = White 3 = Blue 4 = Black 5 = Gray 6 = Pink</p>
PKG6Z-9	9 m (29.53 ft)			
PKW6Z-2	2 m (6.56 ft)	Right-angle		
PKW6Z-9	9 m (29.53 ft)			

5.2 Banner Engineering Corp. Limited Warranty

Banner Engineering Corp. warrants its products to be free from defects in material and workmanship for one year following the date of shipment. Banner Engineering Corp. will repair or replace, free of charge, any product of its manufacture which, at the time it is returned to the factory, is found to have been defective during the warranty period. This warranty does not cover damage or liability for misuse, abuse, or the improper application or installation of the Banner product.

THIS LIMITED WARRANTY IS EXCLUSIVE AND IN LIEU OF ALL OTHER WARRANTIES WHETHER EXPRESS OR IMPLIED (INCLUDING, WITHOUT LIMITATION, ANY WARRANTY OF MERCHANTABILITY OR FITNESS FOR A PARTICULAR PURPOSE), AND WHETHER ARISING UNDER COURSE OF PERFORMANCE, COURSE OF DEALING OR TRADE USAGE.

This Warranty is exclusive and limited to repair or, at the discretion of Banner Engineering Corp., replacement. **IN NO EVENT SHALL BANNER ENGINEERING CORP. BE LIABLE TO BUYER OR ANY OTHER PERSON OR ENTITY FOR ANY EXTRA COSTS, EXPENSES, LOSSES, LOSS OF PROFITS, OR ANY INCIDENTAL, CONSEQUENTIAL OR SPECIAL DAMAGES RESULTING FROM ANY PRODUCT DEFECT OR FROM THE USE OR INABILITY TO USE THE PRODUCT, WHETHER ARISING IN CONTRACT OR WARRANTY, STATUTE, TORT, STRICT LIABILITY, NEGLIGENCE, OR OTHERWISE.**

Banner Engineering Corp. reserves the right to change, modify or improve the design of the product without assuming any obligations or liabilities relating to any product previously manufactured by Banner Engineering Corp. Any misuse, abuse, or improper application or installation of this product or use of the product for personal protection applications when the product is identified as not intended for such purposes will void the product warranty. Any modifications to this product without prior express approval by Banner Engineering Corp will void the product warranties. All specifications published in this document are subject to change; Banner reserves the right to modify product specifications or update documentation at any time. Specifications and product information in English supersede that which is provided in any other language. For the most recent version of any documentation, refer to: www.bannerengineering.com.

For patent information, see www.bannerengineering.com/patents.