

MMBZ5221ELT1 Series

Preferred Device

Zener Voltage Regulators

225 mW SOT-23 Surface Mount

This series of Zener diodes is offered in the convenient, surface mount plastic SOT-23 package. These devices are designed to provide voltage regulation with minimum space requirement. They are well suited for applications such as cellular phones, hand held portables, and high density PC boards.

Features

- 225 mW Rating on FR-4 or FR-5 Board
- Zener Voltage Range – 2.4 V to 91 V
- Package Designed for Optimal Automated Board Assembly
- Small Package Size for High Density Applications
- ESD Rating of Class 3 (>16 kV) per Human Body Model
- Peak Power – 225 W (8 x 20 μ s)
- Pb-Free Packages are Available

Mechanical Characteristics:

CASE: Void-free, transfer-molded, thermosetting plastic case

FINISH: Corrosion resistant finish, easily solderable

MAXIMUM CASE TEMPERATURE FOR SOLDERING PURPOSES:

260°C for 10 Seconds

POLARITY: Cathode indicated by polarity band

FLAMMABILITY RATING: UL 94 V-0

MAXIMUM RATINGS

Rating	Symbol	Max	Unit
Peak Power Dissipation @ 20 μ s (Note 1) @ $T_L \leq 25^\circ\text{C}$	P_{pk}	225	W
Total Power Dissipation on FR-5 Board, (Note 2) @ $T_A = 25^\circ\text{C}$ Derated above 25°C	P_D	225 1.8	mW mW/°C
Thermal Resistance, Junction-to-Ambient	$R_{\theta JA}$	556	°C/W
Total Power Dissipation on Alumina Substrate, (Note 3) @ $T_A = 25^\circ\text{C}$ Derated above 25°C	P_D	300 2.4	mW mW/°C
Thermal Resistance, Junction-to-Ambient	$R_{\theta JA}$	417	°C/W
Junction and Storage Temperature Range	T_J, T_{stg}	-65 to +150	°C

Maximum ratings are those values beyond which device damage can occur. Maximum ratings applied to the device are individual stress limit values (not normal operating conditions) and are not valid simultaneously. If these limits are exceeded, device functional operation is not implied, damage may occur and reliability may be affected.

1. Nonrepetitive current pulse per Figure 9.
2. FR-5 = 1.0 X 0.75 X 0.62 in.
3. Alumina = 0.4 X 0.3 X 0.024 in., 99.5% alumina.



ON Semiconductor®

<http://onsemi.com>

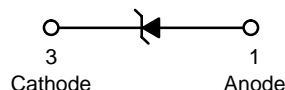

MARKING DIAGRAM

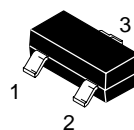

SOT-23
CASE 318
STYLE 8

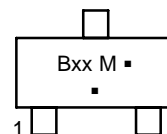

Bxx = Device Code
xx = (Refer to page 2)
M = Date Code*
▪ = Pb-Free Package

(Note: Microdot may be in either location)

*Date Code orientation may vary depending upon manufacturing location.

ORDERING INFORMATION

Device	Package	Shipping†
MMBZ52xxELT1	SOT-23	3000/Tape & Reel
MMBZ52xxELT1G	SOT-23 (Pb-Free)	3000/Tape & Reel
MMBZ52xxELT3	SOT-23	10000/Tape & Reel
MMBZ52xxELT3G	SOT-23 (Pb-Free)	10000/Tape & Reel

†For information on tape and reel specifications, including part orientation and tape sizes, please refer to our Tape and Reel Packaging Specifications Brochure, BRD8011/D.

DEVICE MARKING INFORMATION

See specific marking information in the device marking column of the Electrical Characteristics table on page 2 of this data sheet.

Devices listed in **bold, italic** are ON Semiconductor **Preferred** devices. **Preferred** devices are recommended choices for future use and best overall value.

MMBZ5221ELT1 Series

ELECTRICAL CHARACTERISTICS

(Pinout: 1-Anode, 2-No Connection, 3-Cathode) ($T_A = 25^\circ\text{C}$ unless otherwise noted, $V_F = 0.95\text{ V Max. @ } I_F = 10\text{ mA}$)

Symbol	Parameter
V_Z	Reverse Zener Voltage @ I_{ZT}
I_{ZT}	Reverse Current
Z_{ZT}	Maximum Zener Impedance @ I_{ZT}
I_{ZK}	Reverse Current
Z_{ZK}	Maximum Zener Impedance @ I_{ZK}
I_R	Reverse Leakage Current @ V_R
V_R	Reverse Voltage
I_F	Forward Current
V_F	Forward Voltage @ I_F

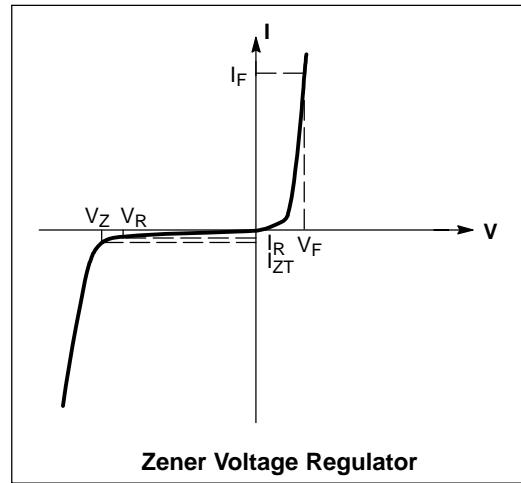

ELECTRICAL CHARACTERISTICS (Pinout: 1-Anode, 2-NC, 3-Cathode) ($V_F = 0.9\text{ V Max @ } I_F = 10\text{ mA}$ for all types.)

Device	Device Marking	Zener Voltage (Note 4)				Zener Impedance			Leakage Current	
		V_Z (V)			@ I_{ZT}	Z_{ZT} @ I_{ZT}	Z_{ZK} @ I_{ZK}		I_R @ V_R	
		Min	Nom	Max	mA	Ω	Ω	mA	μA	V
MMBZ5221ELT1/T3, G	BE2	2.28	2.4	2.52	20	30	1200	0.25	100	1
MMBZ5226ELT1/T3, G	BE7	3.13	3.3	3.47	20	28	1600	0.25	25	1
MMBZ5228ELT1/T3, G	BE9	3.70	3.9	4.10	20	23	1900	0.25	10	1
MMBZ5229ELT1/T3, G	BF1	4.08	4.3	4.52	20	22	2000	0.25	5	1
MMBZ5230ELT1/T3, G	BF2	4.46	4.7	4.94	20	19	1900	0.25	5	2
MMBZ5231ELT1/T3,G	BF3	4.84	5.1	5.36	20	17	1600	0.25	5	2
MMBZ5232ELT1/T3,G	BF4	5.32	5.6	5.88	20	11	1600	0.25	5	3
MMBZ5234ELT1/T3,G	BF6	5.89	6.2	6.51	20	7	1000	0.25	5	4
MMBZ5235ELT1/T3,G	BF7	6.46	6.8	7.14	20	5	750	0.25	3	5
MMBZ5236ELT1/T3, G	BF8	7.12	7.5	7.88	20	6	500	0.25	3	6
MMBZ5237ELT1/T3, G	BF9	7.79	8.2	8.61	20	8	500	0.25	3	6.5
MMBZ5239ELT1/T3, G	BG2	8.65	9.1	9.55	20	10	600	0.25	3	7
MMBZ5240ELT1/T3,G	BG3	9.50	10	10.50	20	17	600	0.25	3	8
MMBZ5242ELT1/T3,G	BG5	11.40	12	12.60	20	30	600	0.25	1	9.1
MMBZ5243ELT1/T3, G	BG6	12.35	13	13.65	9.5	13	600	0.25	0.5	9.9
MMBZ5244ELT1/T3, G	BG7	13.30	14	14.70	9	15	600	0.25	0.1	10
MMBZ5245ELT1/T3,G	BG8	14.25	15	15.75	8.5	16	600	0.25	0.1	11
MMBZ5246ELT1, G†	BG9	15.20	16	16.80	7.8	17	600	0.25	0.1	12
MMBZ5248ELT1/T3,G	BH2	17.10	18	18.90	7	21	600	0.25	0.1	14
MMBZ5250ELT1/T3,G	BH4	19.00	20	21.00	6.2	25	600	0.25	0.1	15

4. Zener voltage is measured with a pulse test current I_Z at an ambient temperature of 25°C .

*The "G" suffix indicates Pb-Free package available.

†MMBZ5246EL, MMBZ5252EL, and MMBZ5265EL Not Available in 10,000/Tape & Reel.

MMBZ5221ELT1 Series

ELECTRICAL CHARACTERISTICS (continued) (Pinout: 1-Anode, 2-NC, 3-Cathode) ($V_F = 0.9$ V Max @ $I_F = 10$ mA for all types.)

Device*	Device Marking	Zener Voltage (Note 5)				Zener Impedance			Leakage Current	
		V_Z (V)			@ I_{ZT}	Z_{ZT} @ I_{ZT}	Z_{ZK} @ I_{ZK}		I_R @ V_R	
		Min	Nom	Max	mA	Ω	Ω	mA	μ A	V
MMBZ5252ELT1, G†	BH6	22.80	24	25.20	5.2	33	600	0.25	0.1	18
MMBZ5253ELT1/T3	BH7	23.75	25	26.25	5	35	600	0.25	0.1	19
MMBZ5254ELT1/T3,G	BH8	25.65	27	28.35	4.6	41	600	0.25	0.1	21
MMBZ5255ELT1/T3, G	BH9	26.60	28	29.40	4.5	44	600	0.25	0.1	21
MMBZ5256ELT1/T3, G	BJ1	28.50	30	31.50	4.2	49	600	0.25	0.1	23
MMBZ5257ELT1/T3,G	BJ2	31.35	33	34.65	3.8	58	700	0.25	0.1	25
MMBZ5258ELT1/T3, G	BJ3	34.20	36	37.80	3.4	70	700	0.25	0.1	27
MMBZ5262ELT1/T3, G	BJ7	48.45	51	53.55	2.5	125	1100	0.25	0.1	37
MMBZ5263ELT1/T3, G	BJ8	53.20	56	58.80	2.2	150	1300	0.25	0.1	43
MMBZ5265ELT1, G†	BK1	58.90	62	65.10	2	185	1400	0.25	0.1	47

5. Zener voltage is measured with a pulse test current I_Z at an ambient temperature of 25°C.

*The "G" suffix indicates Pb-Free package available.

†MMBZ5246EL, MMBZ5252EL, and MMBZ5265EL Not Available in 10,000/Tape & Reel.

MMBZ5221ELT1 Series

TYPICAL CHARACTERISTICS

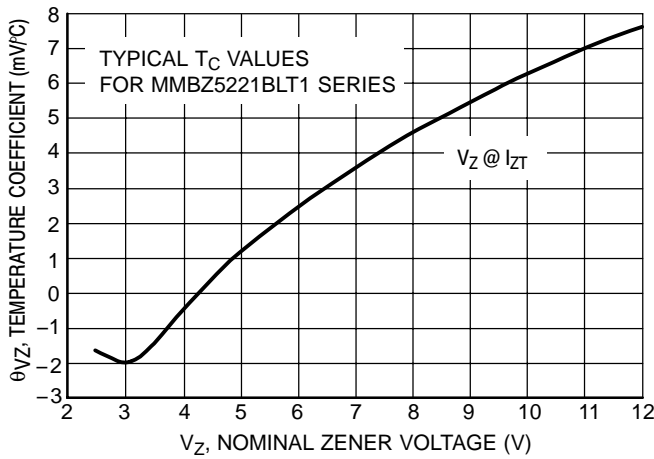

Figure 1. Temperature Coefficients
(Temperature Range -55°C to +150°C)

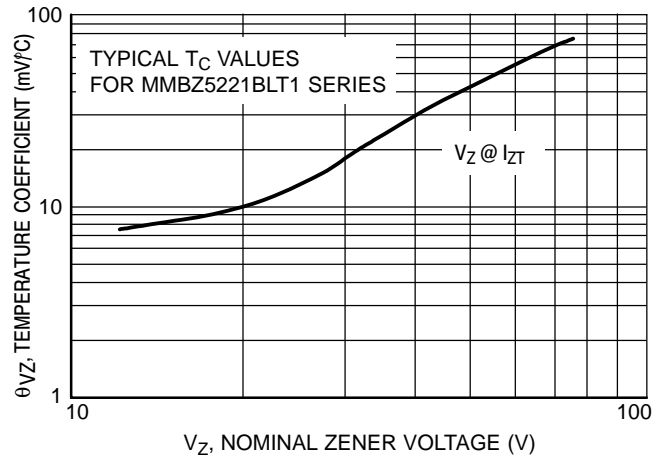

Figure 2. Temperature Coefficients
(Temperature Range -55°C to +150°C)

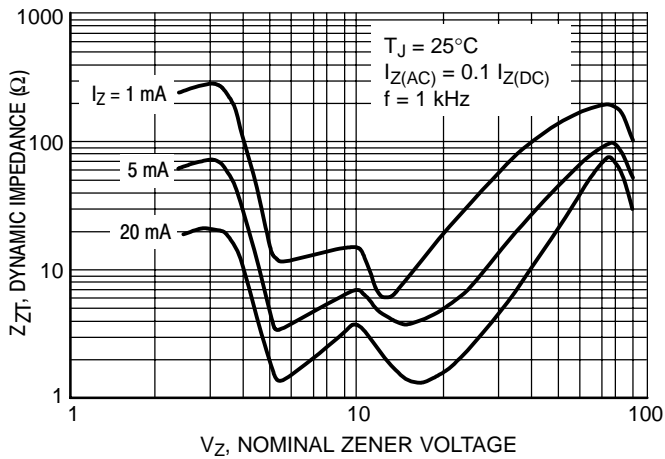

Figure 3. Effect of Zener Voltage on Zener Impedance

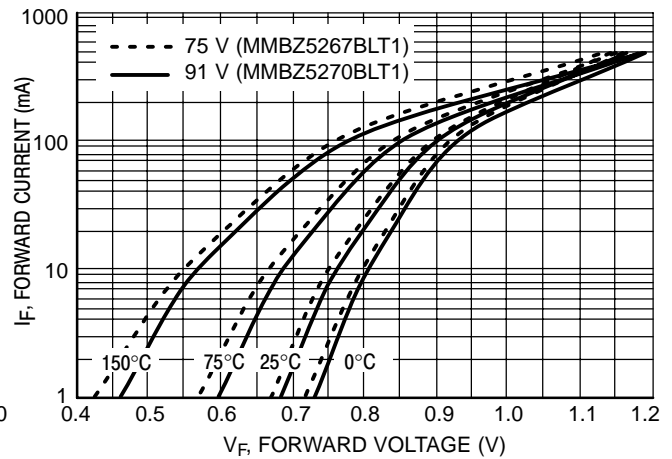

Figure 4. Typical Forward Voltage

MMBZ5221ELT1 Series

TYPICAL CHARACTERISTICS

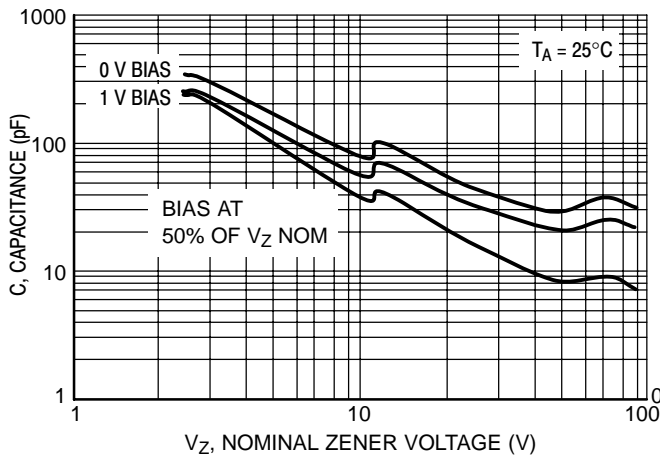

Figure 5. Typical Capacitance

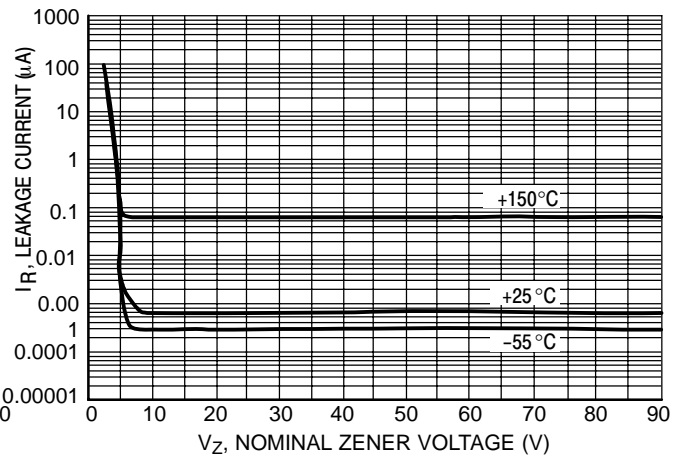

Figure 6. Typical Leakage Current

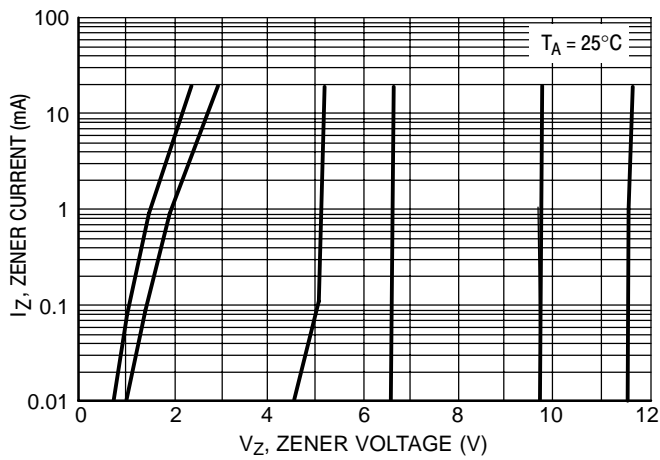

Figure 7. Zener Voltage versus Zener Current (V_Z Up to 12 V)

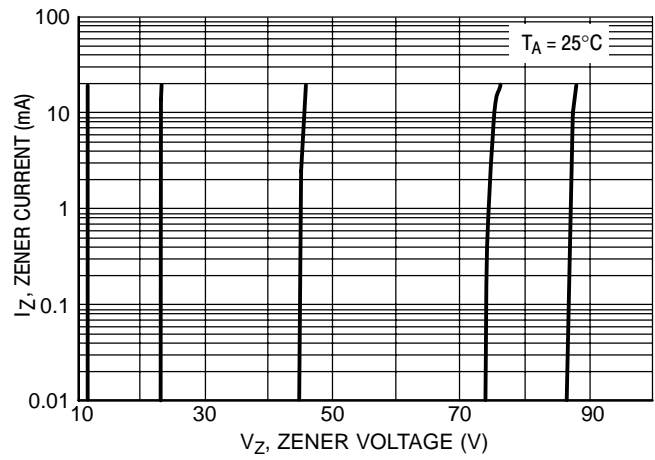

Figure 8. Zener Voltage versus Zener Current (12 V to 91 V)

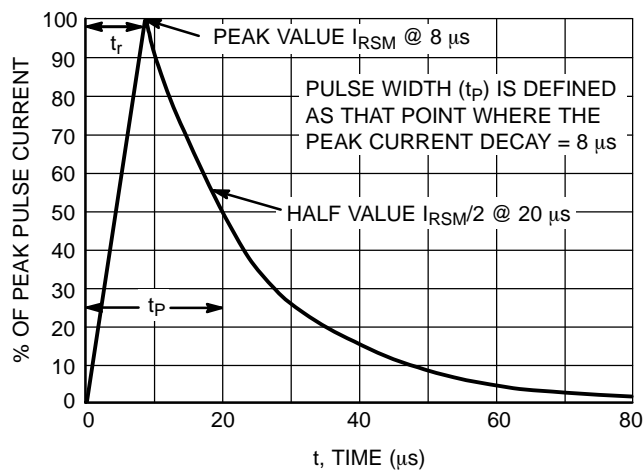
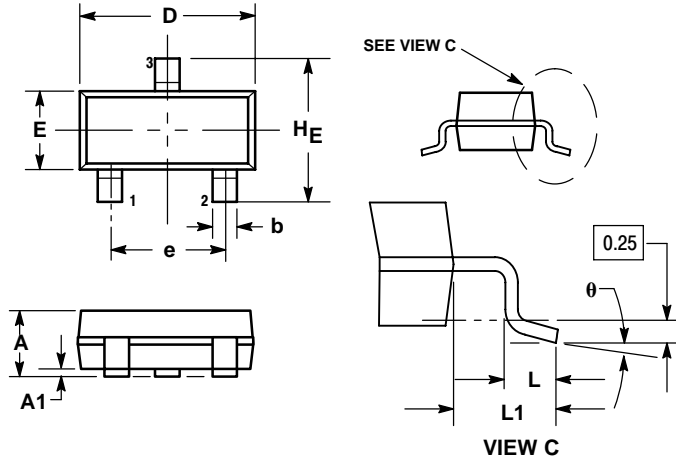

Figure 9. $8 \times 20 \mu\text{s}$ Pulse Waveform

MMB5221ELT1 Series

PACKAGE DIMENSIONS

SOT-23
TO-236AB
CASE 318-08
ISSUE AM



NOTES:

1. DIMENSIONING AND TOLERANCING PER ANSI Y14.5M, 1982.
2. CONTROLLING DIMENSION: INCH.
3. MAXIMUM LEAD THICKNESS INCLUDES LEAD FINISH THICKNESS. MINIMUM LEAD THICKNESS IS THE MINIMUM THICKNESS OF BASE MATERIAL.
4. 318-01 THRU -07 AND -09 OBSOLETE, NEW STANDARD 318-08.

DIM	MILLIMETERS			INCHES		
	MIN	NOM	MAX	MIN	NOM	MAX
A	0.89	1.00	1.11	0.035	0.040	0.044
A1	0.01	0.06	0.10	0.001	0.002	0.004
b	0.37	0.44	0.50	0.015	0.018	0.020
c	0.09	0.13	0.18	0.003	0.005	0.007
D	2.80	2.90	3.04	0.110	0.114	0.120
E	1.20	1.30	1.40	0.047	0.051	0.055
e	1.78	1.90	2.04	0.070	0.075	0.081
L	0.10	0.20	0.30	0.004	0.008	0.012
L1	0.35	0.54	0.69	0.014	0.021	0.029
HE	2.10	2.40	2.64	0.083	0.094	0.104

STYLE 8:

1. ANODE
2. NO CONNECTION
3. CATHODE

SOLDERING FOOTPRINT*

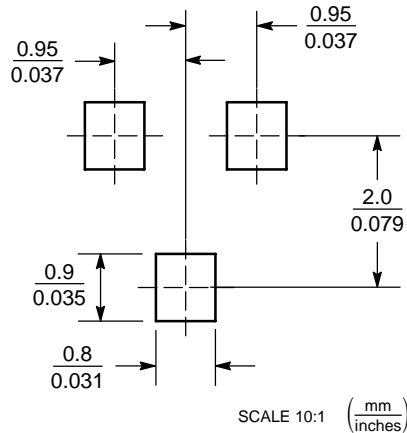

*For additional information on our Pb-Free strategy and soldering details, please download the ON Semiconductor Soldering and Mounting Techniques Reference Manual, SOLDERRM/D.

ON Semiconductor and are registered trademarks of Semiconductor Components Industries, LLC (SCILLC). SCILLC reserves the right to make changes without further notice to any products herein. SCILLC makes no warranty, representation or guarantee regarding the suitability of its products for any particular purpose, nor does SCILLC assume any liability arising out of the application or use of any product or circuit, and specifically disclaims any and all liability, including without limitation special, consequential or incidental damages. "Typical" parameters which may be provided in SCILLC data sheets and/or specifications can and do vary in different applications and actual performance may vary over time. All operating parameters, including "Typicals" must be validated for each customer application by customer's technical experts. SCILLC does not convey any license under its patent rights nor the rights of others. SCILLC products are not designed, intended, or authorized for use as components in systems intended for surgical implant into the body, or other applications intended to support or sustain life, or for any other application in which the failure of the SCILLC product could create a situation where personal injury or death may occur. Should Buyer purchase or use SCILLC products for any such unintended or unauthorized application, Buyer shall indemnify and hold SCILLC and its officers, employees, subsidiaries, affiliates, and distributors harmless against all claims, costs, damages, and expenses, and reasonable attorney fees arising out of, directly or indirectly, any claim of personal injury or death associated with such unintended or unauthorized use, even if such claim alleges that SCILLC was negligent regarding the design or manufacture of the part. SCILLC is an Equal Opportunity/Affirmative Action Employer. This literature is subject to all applicable copyright laws and is not for resale in any manner.

PUBLICATION ORDERING INFORMATION

LITERATURE FULFILLMENT:
Literature Distribution Center for ON Semiconductor
P.O. Box 61312, Phoenix, Arizona 85082-1312 USA
Phone: 480-829-7710 or 800-344-3860 Toll Free USA/Canada
Fax: 480-829-7709 or 800-344-3867 Toll Free USA/Canada
Email: orderlit@onsemi.com

N. American Technical Support: 800-282-9855 Toll Free
USA/Canada

Japan: ON Semiconductor, Japan Customer Focus Center
2-9-1 Kamimeguro, Meguro-ku, Tokyo, Japan 153-0051
Phone: 81-3-5773-3850

ON Semiconductor Website: <http://onsemi.com>

Order Literature: <http://www.onsemi.com/litorder>

For additional information, please contact your local Sales Representative.