

**Three-Phase
Diode Bridge Modules**
100 Amperes/1200-1600 Volts

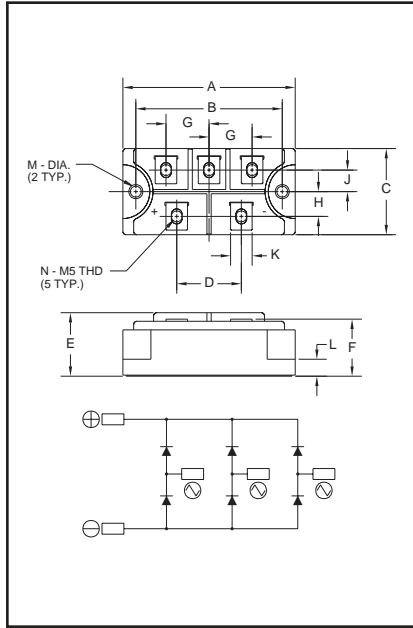

Outline Drawing

Dimension	Inches	Millimeters
A	3.15	80
B	2.677±0.010	68±0.25
C	1.57	40
D	1.18	30
E	1.16	29.5
F	1.04	26.5
G	0.79	20
H	0.45	11.5
J	0.41	10.5
K	0.39	10
L	0.31	8
M	0.216 Dia.	Dia. 5.5
N	M5 Metric	M5



ME501210, ME501610
Three-Phase Diode Bridge Modules
100 Amperes/1200-1600 Volts

Description:

Powerex Three-Phase Diode Bridge Modules are designed for use in three-phase bridge applications. The modules are isolated consisting of six rectifier diodes.

Features:

- Isolated Mounting
- Planar Chips

Applications:

- Inverters
- DC Power Supplies
- AC Motor Control Front End

Ordering Information:

Select the complete eight digit module part number you desire from the table below.

Example: ME501210 is a 1200 Volt, 100 Ampere Three-Phase Diode Bridge Module.

Type	Voltage Volts (x100)	Current Rating Amperes (x10)
ME50	12 16	10



Powerex, Inc., 200 Hillis Street, Youngwood, Pennsylvania 15697-1800 (724) 925-7272

ME501210, ME501610
Three-Phase Diode Bridge Modules
100 Amperes/1200-1600 Volts

Absolute Maximum Ratings

Characteristics	Symbol	ME501210	ME501610	Units
Peak Reverse Blocking Voltage	V_{RRM}	1200	1600	Volts
Transient Peak Reverse Blocking Voltage (Non-Repetitive), $t < 5ms$	V_{RSM}	1350	1700	Volts
DC Reverse Blocking Voltage	$V_{R(DC)}$	960	1280	Volts
DC Output Current, $T_C = 102^\circ C$	I_O	100	100	Amperes
Peak One-Cycle Surge (Non-Repetitive) On-State Current (60Hz)	I_{FSM}	1000	1000	Amperes
Peak One-Cycle Surge (Non-Repetitive) On-State Current (50Hz)	I_{FSM}	910	910	Amperes
I^2t (for Fusing), 8.3 milliseconds	I^2t	4200	4200	A ² sec
Storage Temperature	T_{STG}	-40 to 125	-40 to 125	°C
Operating Temperature	T_j	-40 to 150	-40 to 150	°C
Maximum Mounting Torque M5 Mounting Screw	—	17	17	in.-lb.
Maximum Mounting Torque M5 Terminal Screw	—	17	17	in.-lb.
Module Weight (Typical)	—	220	220	Grams
V Isolation	V_{RMS}	2500	2500	Volts



Powerex, Inc., 200 Hillis Street, Youngwood, Pennsylvania 15697-1800 (724) 925-7272

ME501210, ME501610
Three-Phase Diode Bridge Modules
100 Amperes/1200-1600 Volts

Electrical and Thermal Characteristics, $T_j = 25^\circ\text{C}$ unless otherwise specified

Characteristics	Symbol	Test Conditions	ME501210/ME501610	Units
Blocking State Maximums				
Reverse Leakage Current, Peak	I_{RRM}	$T_j = 150^\circ\text{C}$, $V_{RRM} = \text{Rated}$	10	mA
Conducting State Maximums				
Peak On-State Voltage	V_{FM}	$I_{FM} = 100\text{A}$	1.2	Volts
Thermal Maximums				
Thermal Resistance, Junction-to-Case	$R_{\theta(J-C)}$	Per Module	0.2	$^\circ\text{C/Watt}$
Thermal Resistance, Case-to-Sink (Lubricated)	$R_{\theta(C-S)}$	Per Module	0.06	$^\circ\text{C/Watt}$

ME501210, ME501610
Three-Phase Diode Bridge Modules
 100 Amperes/1200-1600 Volts

