

## SUMMARY



Image is for illustrative purpose only

### # Wires

Low voltage 4

Series OK  
Termination type Female solder  
IP rating 68 mated (mating interface)  
AWG wire size 30.00 - 22.00  
Cable Ø 0.00 - 0.00 mm  
Status active  
Matching parts [FGG.0K.304.CLAC40](#)

### Download

[Request a quote](#)  
[Catalog](#)

## TECHNICAL DETAILS

### Mechanics

Shell Style/Model EE\*: Fixed receptacle, nut fixing (back panel mounting)  
Keying 1 key (alpha=0, plug: male contacts, receptacle: female contacts)  
Housing Material Brass (chrome plated [SAE AMS 2460]) shell, collet nut and latch sleeve, nickel plated [SAE AMS QQ N 290] brass mid pieces  
Weight 11.76 g

### Performance

Configuration OK.304 : 4 Low Voltage  
Insulator L: PEEK (UL 94 / V-0/1.5)  
Rated Current 7 Amps

### Specifications

Contact Type: Solder  
Contact Dia.: 0.7 mm (0.028in)  
Bucket Dia.: 0.8 mm (0.031in)  
Max. Solid Conductor: 0.34 mm<sup>2</sup> (AWG 22)  
Max. Stranded Conductor: 0.34 mm<sup>2</sup> (AWG 22)  
R (max): 6.1 mOhm  
Vtest (contact-shell): 700 V (AC), 990 V (DC)  
Vtest (contact-contact): 850 V (AC), 1200 V (DC)

LEMO products and services are provided "as is". LEMO makes no warranties or representations with regard to LEMO product & services or use of them, express, implied or statutory, including for accuracy, completeness, or security. The user is fully responsible for his products and applications using LEMO components.

## Others

Endurance (Shell): 5000 mating cycles  
Temp (min / max): -55°C / +200°C  
Humidity (max): <=95% [at 60 deg C / 140 F]  
Vibration: 15 g [10 Hz - 2000 Hz]  
Shock Resistance: 100 g [ 6 ms]  
Climatical Category: 50/175/21  
Shielding (min): 95 dB (10 MHz)  
Shielding (min): 80 dB (1 GHz)  
Salt Spray Corrosion: >1000 hr

## DRAWINGS

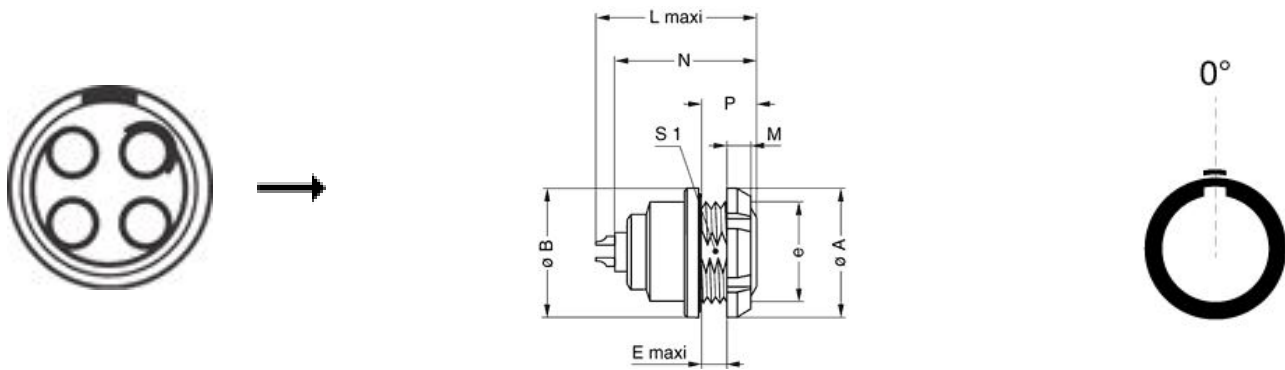

## Dimensions

	A	B	E	L	M	N	P	S1	e
mm.	18	18	3.4	21.7	3.5	20.1	7	12.5	M14x1.0
in.	0,71	0,71	0,13	0,85	0,14	0,79	0,28	0,49	



















## RECOMMENDED BY LEMO

### Tools

Spanner wrench: [Socket for torque wrench DCM.0E.M14.4](#)

*LEMO products and services are provided "as is". LEMO makes no warranties or representations with regard to LEMO product & services or use of them, express, implied or statutory, including for accuracy, completeness, or security. The user is fully responsible for his products and applications using LEMO components.*

## Cables

CMN.04.T22.047QGC	TPR	Grey	
CMN.04.T22.048QGZE	TPR (medical)	Grey	
CMN.04.T28.031PGCE	PVC	GREY	
CMN.04.T28.031PGZE		Grey	
CMN.04.T28.031PNCE	PVC	Black	
CMN.04.T28.031PNZE			
CMN.04.T28.031QGC	TPR	Grey	
140240	PVC	Black	
140250	PVC	Grey	
40080	PVC	Black	
40086	PVC	Blue	
40140	PVC	Black	
40240	PTFE	White	
40260	PVC	Black	
4041	PVC	Grey	
4050	PVC	Black	
4080	PVC	Grey	
417920	PVC	Grey	
4220	PVC	Black	
4221	PVC	Black	
4260	PTFE	White	
4280	PVC	Black	
80080	PVC	Grey	
80082	PVC	Red	
80084	PVC	Black	
CTR.75.030.121870G	PVC	Grey	

LEMO products and services are provided "as is". LEMO makes no warranties or representations with regard to LEMO product & services or use of them, express, implied or statutory, including for accuracy, completeness, or security. The user is fully responsible for his products and applications using LEMO components.