



The Future of Analog IC Technology®

# MP1497

## High-Efficiency, 3A, 16V, 500kHz Synchronous, Step-Down Converter

### DESCRIPTION

The MP1497 is a high-frequency, synchronous, rectified, step-down switch mode converter with built in internal power MOSFETs. It offers a very compact solution to achieve 3A continuous output current with excellent load and line regulation over a wide input supply range. The MP1497 has synchronous mode operation for higher efficiency over the output current load range.

Current-mode operation provides a fast transient response and eases loop stabilization.

Protective features include over-current protection, thermal shutdown, and external SS control.

The MP1497 requires a minimal number of readily-available external components and is available in a space-saving 8-pin TSOT23 package.

### FEATURES

- Wide 4.5V-to-16V Operating Input Range
- 80mΩ/30mΩ Low  $R_{DS(ON)}$  Internal Power MOSFETs
- Proprietary Switching-Loss-Reduction Technique
- High-Efficiency Synchronous Mode Operation
- Fixed 500kHz Switching Frequency
- Can Synchronize to a 200kHz-to-2MHz External Clock
- Externally-Programmable Soft-Start
- OCP and Hiccup
- Thermal Shutdown
- Output Adjustable from 0.8V
- Available in an 8-pin TSOT-23 Package

### APPLICATIONS

- Notebook Systems and I/O Power
- Digital Set-Top Boxes
- Flat-Panel Televisions and Monitors
- Distributed Power Systems

All MPS parts are lead-free and adhere to the RoHS directive. For MPS green status, please visit MPS website under Products, Quality Assurance page.

"MPS" and "The Future of Analog IC Technology" are registered trademarks of Monolithic Power Systems, Inc.

### TYPICAL APPLICATION

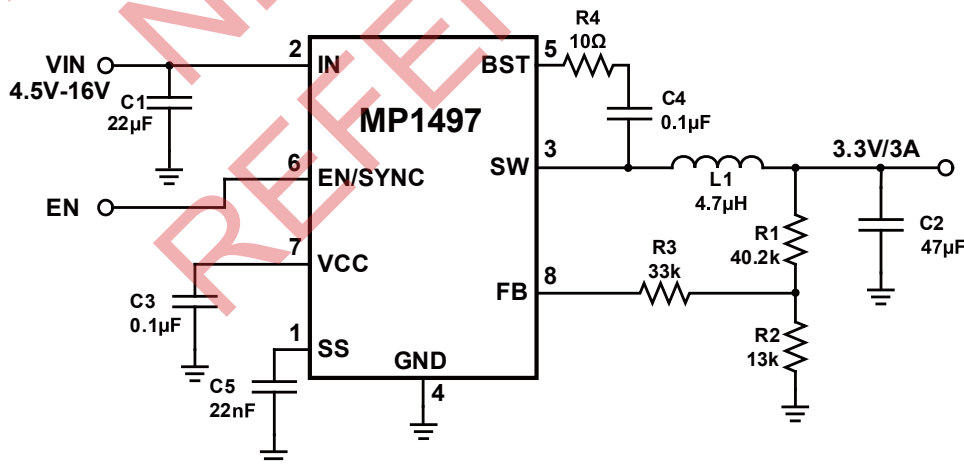

**ORDERING INFORMATION**

| Part Number* | Package   | Top Marking |
|--------------|-----------|-------------|
| MP1497DJ     | TSOT-23-8 | ACQ         |

For Tape & Reel, add suffix -Z (e.g. MP1497DJ-Z);  
 For RoHS, compliant packaging, add suffix -LF (e.g. MP1497DJ-LF-Z).

**PACKAGE REFERENCE**

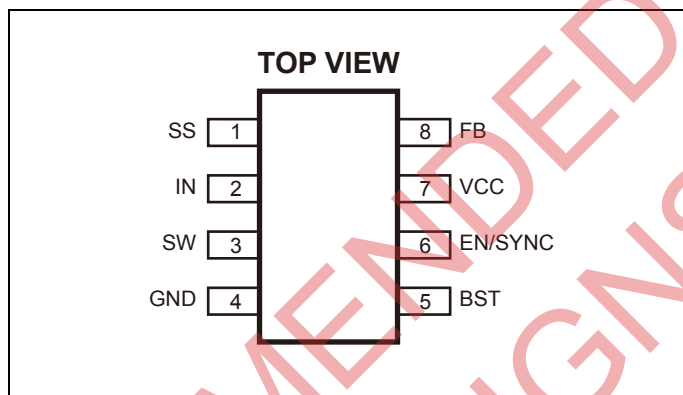

**ABSOLUTE MAXIMUM RATINGS** <sup>(1)</sup>

|  |  |
|--|--|
| $V_{IN}$ .....   | -0.3V to 17V                               |
| $V_{SW}$ ...   | -0.3V (-5V for <10ns) to 17V (19V for 5ns) |
| $V_{BS}$ .....   | $V_{SW}+6V$                                |
| All Other Pins .....   | -0.3V to 6V <sup>(2)</sup>                 |
| Continuous Power Dissipation ( $T_A = +25^{\circ}C$ ) <sup>(3)</sup> | 1.25W                                      |
| Junction Temperature .....   | 150°C                                      |
| Lead Temperature .....   | 260°C                                      |
| Storage Temperature .....  | -65°C to 150°C                             |

**Recommended Operating Conditions** <sup>(4)</sup>

|  |                     |
|--|---------------------|
| Supply Voltage $V_{IN}$ .....            | 4.5V to 16V         |
| Output Voltage $V_{OUT}$ .....           | 0.8V to $V_{IN}-3V$ |
| Operating Junction Temp. ( $T_J$ ) ..... | -40°C to +125°C     |

**Thermal Resistance** <sup>(5)</sup>

|                 | $\theta_{JA}$ | $\theta_{JC}$ |
|-----------------|---------------|---------------|
| TSOT-23-8 ..... | 100           | 55            |

°C/W

**Notes:**

- Exceeding these ratings may damage the device.
- About the details of the EN pin's ABS MAX rating, please refer to Page 9, Enable section.
- The maximum allowable power dissipation is a function of the maximum junction temperature  $T_J$  (MAX), the junction-to-ambient thermal resistance  $\theta_{JA}$ , and the ambient temperature  $T_A$ . The maximum allowable continuous power dissipation at any ambient temperature is calculated by  $P_D$  (MAX) =  $(T_J$  (MAX) -  $T_A$ ) /  $\theta_{JA}$ . Exceeding the maximum allowable power dissipation will cause excessive die temperature, and the regulator will go into thermal shutdown. Internal thermal shutdown circuitry protects the device from permanent damage.
- The device is not guaranteed to function outside of its operating conditions.
- Measured on JESD51-7, 4-layer PCB.

## ELECTRICAL CHARACTERISTICS

$V_{IN} = 12V$ ,  $T_A = 25^{\circ}C$ , unless otherwise noted.

| Parameter   | Symbol            | Condition   | Min | Typ  | Max | Units       |
|---|-------------------|---|-----|------|-----|-------------|
| Supply Current (Shutdown)                           | $I_{IN}$          | $V_{EN} = 0V$                                     |     |      | 1   | $\mu A$     |
| Supply Current (Quiescent)                          | $I_q$             | $V_{EN} = 2V$ , $V_{FB} = 1V$                     |     | 0.7  | 1   | mA          |
| HS-Switch ON Resistance                             | $HS_{RDS-ON}$     | $V_{BST-SW}=5V$                                   |     | 80   |     | m $\Omega$  |
| LS-Switch ON Resistance                             | $LS_{RDS-ON}$     | $V_{CC}=5V$                                       |     | 30   |     | m $\Omega$  |
| Switch Leakage                                      | $SW_{LKG}$        | $V_{EN} = 0V$ , $V_{SW} = 12V$                    |     |      | 1   | $\mu A$     |
| Current Limit <sup>(6)</sup>                        | $I_{LIMIT}$       | Under 40% Duty Cycle                              | 4.2 | 5    |     | A           |
| Oscillator Frequency                                | $f_{SW}$          | $V_{FB}=750mV$                                    | 440 | 500  | 580 | kHz         |
| Fold-back Frequency                                 | $f_{FB}$          | $V_{FB}<400mV$                                    |     | 0.25 |     | $f_{SW}$    |
| Maximum Duty Cycle                                  | $D_{MAX}$         | $V_{FB}=700mV$                                    | 90  | 95   |     | %           |
| Minimum ON Time <sup>(6)</sup>                      | $T_{ON\_MIN}$     |   |     | 60   |     | ns          |
| Sync Frequency Range                                | $f_{SYNC}$        |   | 0.2 |      | 2   | MHz         |
| Feedback Voltage                                    | $V_{FB}$          | $T_A=25^{\circ}C$                                 | 791 | 807  | 823 | mV          |
|   |                   | $-40^{\circ}C < T_A < 85^{\circ}C$ <sup>(7)</sup> | 787 | 807  | 827 |             |
| Feedback Current                                    | $I_{FB}$          | $V_{FB}=820mV$                                    |     | 10   | 50  | nA          |
| EN Rising Threshold                                 | $V_{EN\_RISING}$  |   | 1.2 | 1.4  | 1.6 | V           |
| EN Falling Threshold                                | $V_{EN\_FALLING}$ |   | 1.1 | 1.25 | 1.4 | V           |
| EN Input Current                                    | $I_{EN}$          | $V_{EN}=2V$                                       |     | 2    |     | $\mu A$     |
|   |                   | $V_{EN}=0$  |     | 0    |     | $\mu A$     |
| EN Turn Off Delay                                   | $EN_{Td-off}$     |   |     | 8    |     | $\mu s$     |
| $V_{IN}$ Under-Voltage Lockout Threshold-Rising     | $INUV_{Vth}$      |   | 3.7 | 3.9  | 4.1 | V           |
| $V_{IN}$ Under-Voltage Lockout Threshold-Hysteresis | $INUV_{HYS}$      |   |     | 650  |     | mV          |
| VCC Regulator                                       | $V_{CC}$          |   |     | 5    |     | V           |
| VCC Load Regulation                                 |                   | $I_{CC}=5mA$                                      |     | 3    |     | %           |
| Soft-Start Current                                  | $I_{SS}$          |   | 5   | 11   | 17  | $\mu A$     |
| Thermal Shutdown <sup>(6)</sup>                     |                   |   |     | 150  |     | $^{\circ}C$ |
| Thermal Hysteresis <sup>(6)</sup>                   |                   |   |     | 20   |     | $^{\circ}C$ |

**Notes:**

6) Guaranteed by design.

7) Not tested in production and guaranteed by over-temperature correlation.

## TYPICAL PERFORMANCE CHARACTERISTICS

Performance waveforms are tested on the evaluation board in the Design Example section.  
 $T_A = 25^\circ\text{C}$ , unless otherwise noted.

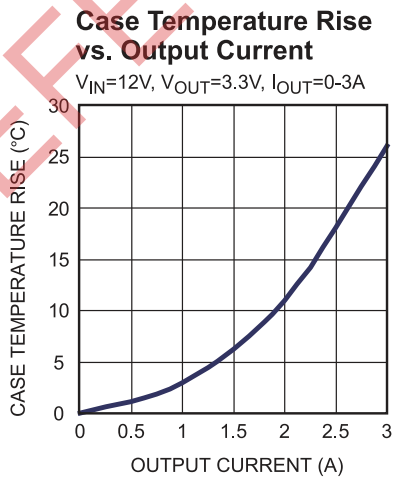
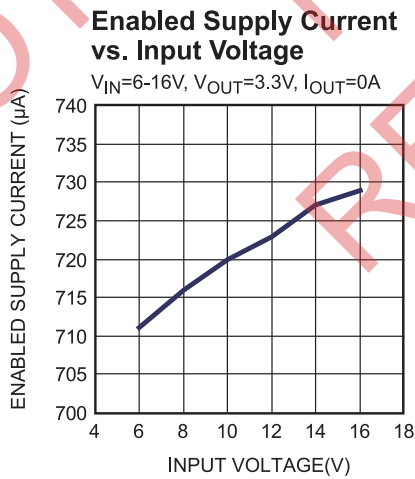
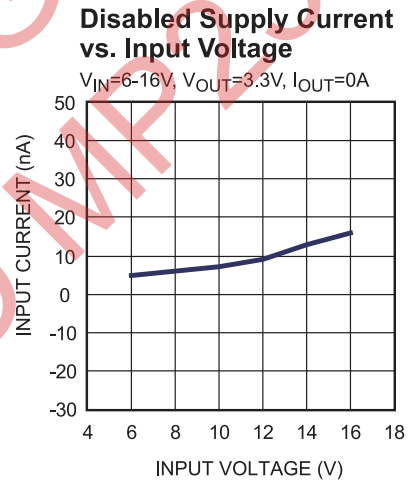
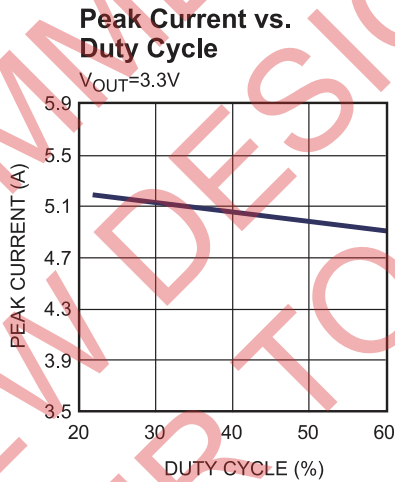
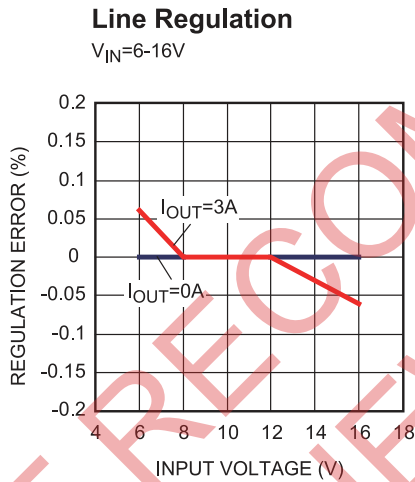
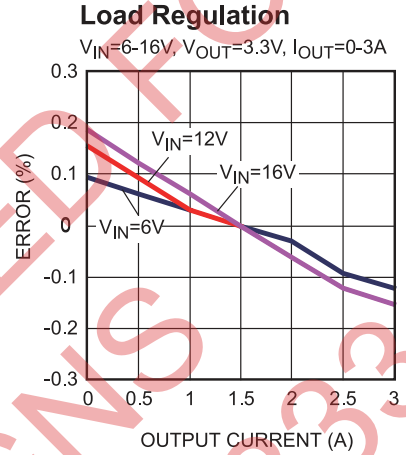
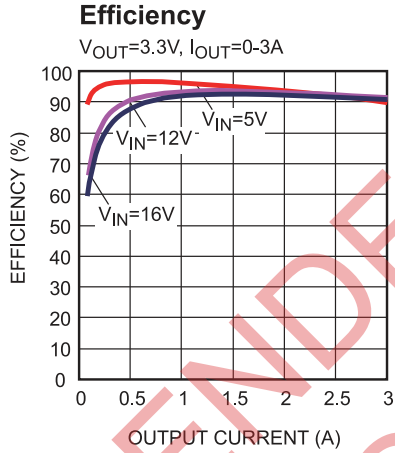
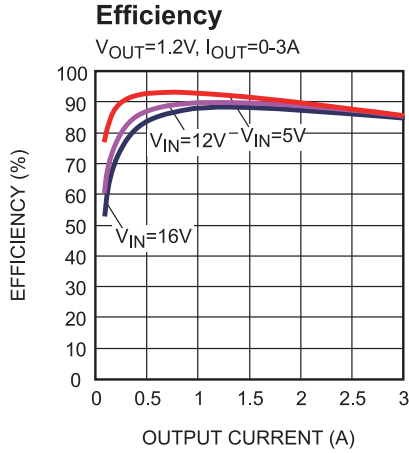

**TYPICAL PERFORMANCE CHARACTERISTICS** (continued)

Performance waveforms are tested on the evaluation board in the Design Example section.  
 $T_A = 25^\circ\text{C}$ , unless otherwise noted.

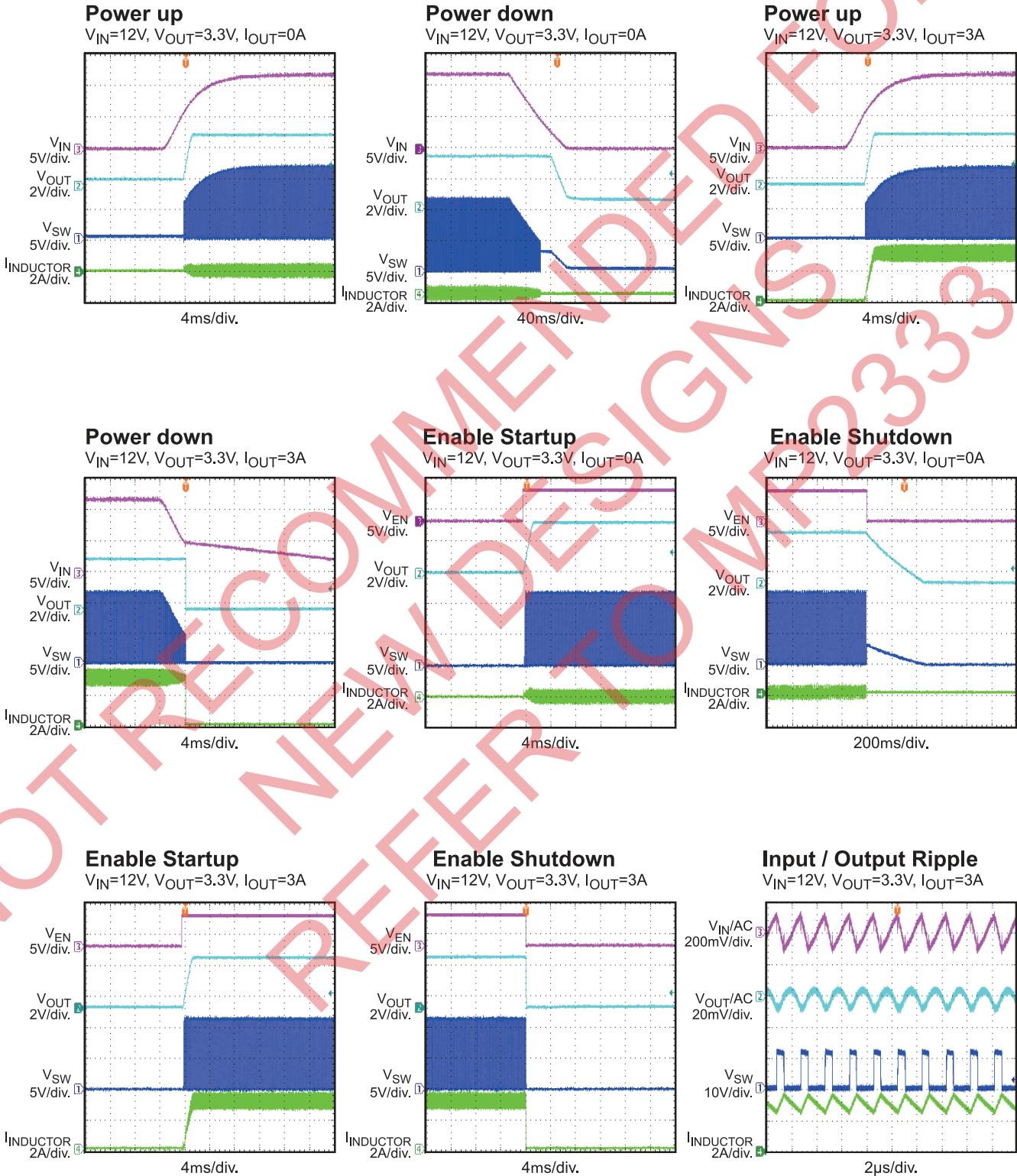

**TYPICAL PERFORMANCE CHARACTERISTICS** (continued)

Performance waveforms are tested on the evaluation board in the Design Example section.  
 $T_A = 25^\circ\text{C}$ , unless otherwise noted.

**Short Circuit Entry**

$V_{IN}=12\text{V}$ ,  $V_{OUT}=3.3\text{V}$ ,  $I_{OUT}=0\text{A}$

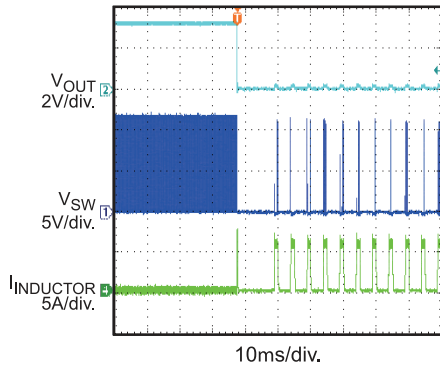

**Short Circuit Recovery**

$V_{IN}=12\text{V}$ ,  $V_{OUT}=3.3\text{V}$ ,  $I_{OUT}=0\text{A}$

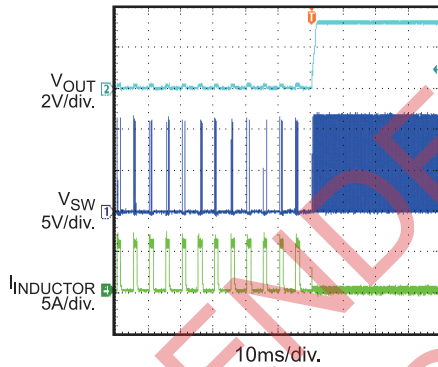

**Transient Response**

$V_{IN}=12\text{V}$ ,  $V_{OUT}=3.3\text{V}$ ,  $I_{OUT}=1.5\text{-}3\text{A}$ ,  $1\text{A}/\mu\text{s}$

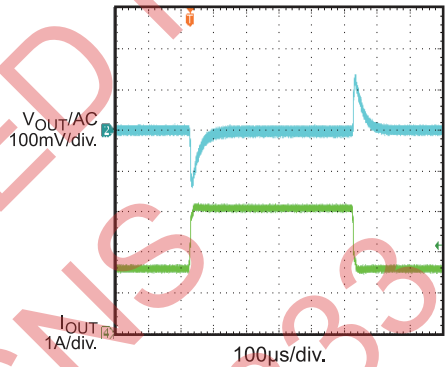

NOT RECOMMENDED FOR NEW DESIGNERS REFER TO MP2333

## PIN FUNCTIONS

| Package Pin # | Name    | Description   |
|---------------|---------|---|
| 1             | SS      | Soft-Start. Connect an external capacitor to program the soft start time for the switch-mode regulator.   |
| 2             | IN      | Supply Voltage. The MP1497 operates from a 4.5V-to-16V input rail. Use C1 to decouple the input rail. Connect using a wide PCB trace.   |
| 3             | SW      | Switch Output. Connect using a wide PCB trace.  |
| 4             | GND     | System Ground. The regulated output voltage reference ground. Connect to GND with copper and vias.  |
| 5             | BST     | Bootstrap. Connect a capacitor between SW and BST pins to form a floating supply across the high-side switch driver. A 10Ω resistor placed between SW and BST cap. is strongly recommended to reduce SW spike voltage.  |
| 6             | EN/SYNC | Enable/Synchronize. EN high to enable the MP1497. Apply an external clock to change the switching frequency.  |
| 7             | VCC     | Bias Supply. Decouple with a 0.1μF-to-0.22μF capacitor. Avoid a capacitance that exceeds 0.22Mf. VCC capacitor should be put closely to VCC pin and GND pin.  |
| 8             | FB      | Feedback. Connect to the tap of an external resistor divider from the output to GND to set the output voltage. The comparator lowers the oscillator frequency when the FB voltage drops below 400mV to prevent current-limit run-away during a short-circuit fault. |



**BLOCK DIAGRAM**

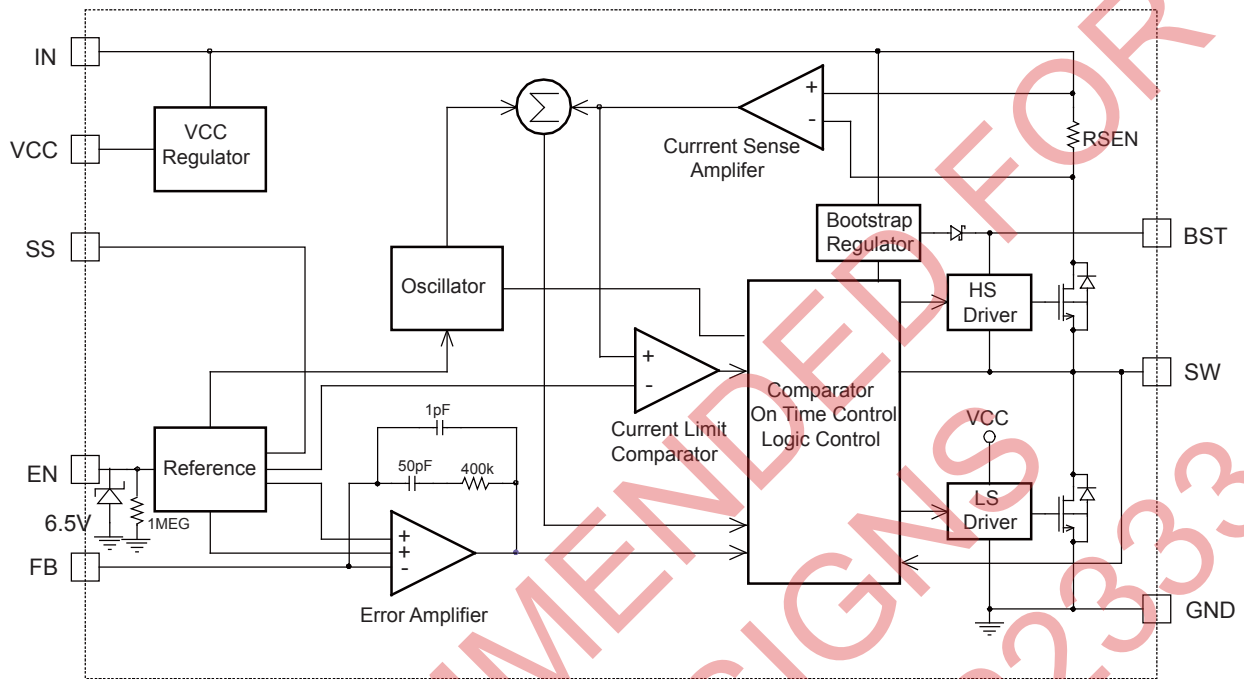

**Figure 1: Functional Block Diagram**



## OPERATION

The MP1497 is a high-frequency, synchronous, rectified, step-down, switch-mode converter with built-in power MOSFETs. It offers a very compact solution to achieve 3A continuous output current with excellent load and line regulation over a wide input supply range.

The MP1497 operates in a fixed-frequency, peak-current-control mode to regulate the output voltage. The internal clock initiates a PWM cycle. The integrated high-side power MOSFET turns on and remains on until its current reaches the value set by the COMP voltage. When the power switch is off, it remains off until the next clock cycle starts. If the current in the power MOSFET does not reach the COMP set current value within 95% of one PWM period, the power MOSFET will be forced to turn off.

### Internal Regulator

The 5V internal regulator powers most of the internal circuitries. This regulator takes the  $V_{IN}$  input and operates in the full  $V_{IN}$  range. When  $V_{IN}$  exceeds 5.0V, the output of the regulator is in full regulation. When  $V_{IN}$  is below 5.0V, the output decreases and requires a 0.1µF ceramic decoupling capacitor.

### Error Amplifier

The error amplifier compares the FB pin voltage against the internal 0.8V reference (REF) and outputs a COMP voltage that controls the power MOSFET current. The optimized internal compensation network minimizes the external component counts and simplifies the control loop design.

### Enable/SYNC Control

EN is a digital control pin that turns the regulator on and off. Drive EN high to turn on the regulator, drive it low to turn it off. An internal 1MΩ resistor from EN to GND allows EN to float to shut down the chip.

The EN pin is clamped internally using a 6.5V series-Zener-diode as shown in Figure 2. Connecting the EN pin through a pullup resistor to any voltage connected to  $V_{IN}$  limits the EN input current to less than 100µA.

For example, when connecting  $V_{IN}$  to a 12V source,  $R_{PULLUP} \geq [(12V - 6.5V) \div 100\mu A = 55k\Omega]$ . Connecting the EN pin directly to a voltage source without any pullup resistor requires limiting the amplitude of the voltage source to below 6.5V to prevent damaging the Zener diode.

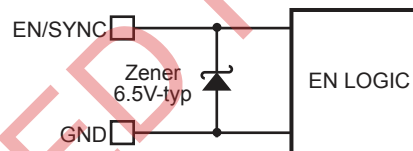

**Figure 2: Zener Diode Circuit**

For external clock synchronization, connect a clock with a frequency range of 200kHz and 2MHz 2ms after the output voltage is set: The internal clock rising edge will synchronize with the external clock rising edge. Select an external clock signal with a pulse-width less than 1.7µs.

### Under-Voltage Lockout

Under-voltage lockout (UVLO) protects the chip from operating at an insufficient supply voltage. The MP1497 UVLO comparator monitors the output voltage of the internal regulator, VCC. The UVLO rising threshold is about 3.9V while its falling threshold is 3.25V.

### External Soft-Start

Adjust the soft-start time by connecting a capacitor from the SS pin to ground. When the soft-start period starts, an internal 11µA current source charges the external capacitor. The soft-start capacitor connects to the non-inverting input of the error amplifier. The soft-start period lasts until the voltage on the soft-start capacitor exceeds the reference voltage of 0.8V. At this point, the non-inverting amplifier uses the reference voltage. The soft-start time can be calculated as:

$$t_{ss}(\text{ms}) = \frac{0.8V \times C_{ss}(\text{nF})}{11\mu A}$$

### Over-Current-Protection and Hiccup

The MP1497 has a cycle-by-cycle over-current limit that protects against the inductor current peak value exceeding the set current limit threshold. Under-voltage protection (UVP) triggers if the FB voltage drops below the

under-voltage (UV) threshold—typically 50% below the reference. Once UVP triggers, the MP1497 enters hiccup mode to periodically restart the part. This protection mode is especially useful when the output is dead-shortened to ground. The average short-circuit current falls to alleviate thermal issues and to protect the regulator. The MP1497 exits hiccup mode once the over-current condition is removed.

**Thermal Shutdown**

Thermal shutdown prevents the chip from operating at exceedingly high temperatures. When the silicon die temperature exceeds 150°C, it shuts down the whole chip. When the temperature drops below its lower threshold (typically 130°C) the chip is enabled again.

**Floating Driver and Bootstrap Charging**

An external bootstrap capacitor powers the floating power MOSFET driver. This floating driver has its own UVLO protection with a rising threshold of 2.2V and a hysteresis of 150mV. The bootstrap capacitor voltage is regulated internally by  $V_{IN}$  through D1, M1, C4, L1 and C2 (Figure 3). If  $(V_{IN}-V_{SW})$  exceed 5V, U1 will regulate M1 to maintain a 5V BST voltage across C4. A 10Ω resistor placed between SW and BST cap. is strongly recommended to reduce SW spike voltage.

Three events can shut down the chip: EN low,  $V_{IN}$  low, and thermal shutdown. For the shutdown procedure, the signaling path is first blocked to avoid any fault triggering. The COMP voltage and the internal supply rail are then pulled down. The floating driver is not subject to this shutdown command.

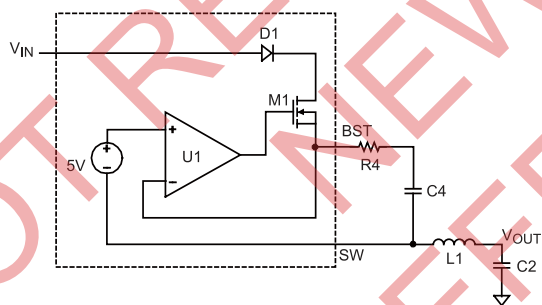

**Figure 3: Internal Bootstrap Charging Circuit, Startup and Shutdown**

If both  $V_{IN}$  and EN exceed their appropriate thresholds, the chip starts. The reference block starts first, generating stable reference voltage and currents, and then the internal regulator is enabled. The regulator provides stable supply for the remaining circuitries.

## APPLICATION INFORMATION

### Setting the Output Voltage

The external resistor divider sets the output voltage (see Typical Application on page 1). The feedback resistor (R1) sets the feedback loop bandwidth in conjunction with the internal compensation capacitor. R2 is then:

$$R2 = \frac{R1}{\frac{V_{OUT}}{0.807V} - 1}$$

The T-type network shown in Figure 4 is highly recommended.

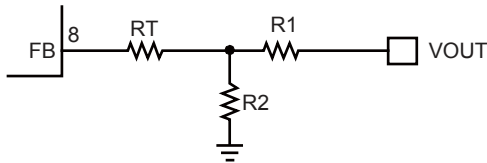

**Figure 4: T-Type Network**

Table 1 lists the recommended T-type resistors value for common output voltages.

**Table 1: Resistor Values for Common Output Voltages**

| V <sub>OUT</sub> (V) | R1 (kΩ) | R2 (kΩ) | Rt (kΩ) |
|----------------------|---------|---------|---------|
| 1.0                  | 20.5    | 82      | 82      |
| 1.2                  | 30.1    | 60.4    | 82      |
| 1.8                  | 40.2    | 32.4    | 56      |
| 2.5                  | 40.2    | 19.1    | 33      |
| 3.3                  | 40.2    | 13      | 33      |
| 5                    | 40.2    | 7.68    | 33      |

### Selecting the Inductor

Use a 1μH-to-10μH inductor with a DC current rating of at least 25% percent higher than the maximum load current for most applications. For highest efficiency, select an inductor with a DC resistance less than 15mΩ. For most designs, calculate the inductance value with:

$$L_1 = \frac{V_{OUT} \times (V_{IN} - V_{OUT})}{V_{IN} \times \Delta I_L \times f_{OSC}}$$

Where ΔI<sub>L</sub> is the inductor ripple current.

Choose an inductor ripple current to be approximately 30% of the maximum load current. The maximum inductor peak current is:

$$I_{L(MAX)} = I_{LOAD} + \frac{\Delta I_L}{2}$$

Use a larger inductance for improved light-load efficiency.

### Selecting the Input Capacitor

The input current to the step-down converter is discontinuous, therefore requires a capacitor supply the AC current to the step-down converter while maintaining the DC input voltage. Use low-ESR capacitors for the best performance, such as ceramic capacitors with X5R or X7R dielectrics that have low ESR and small temperature coefficients. For most applications, use a 22μF capacitor.

The input capacitor (C1) requires an adequate ripple current rating because it absorbs the input switching current. Estimate the RMS current in the input capacitor as:

$$I_{C1} = I_{LOAD} \times \sqrt{\frac{V_{OUT}}{V_{IN}} \times \left(1 - \frac{V_{OUT}}{V_{IN}}\right)}$$

The worst-case condition occurs at V<sub>IN</sub>=2V<sub>OUT</sub>, where:

$$I_{C1} = \frac{I_{LOAD}}{2}$$

For simplification, choose the input capacitor with an RMS current rating greater than half of the maximum load current.

The input capacitor can be electrolytic, tantalum or ceramic. When using electrolytic or tantalum capacitors, include a small, high-quality, ceramic capacitor—e.g. 0.1μF—as close to the IC as possible. When using ceramic capacitors, make sure that they have enough capacitance to prevent excessive input voltage ripple. Estimate the input voltage ripple caused by the capacitance as:

$$\Delta V_{IN} = \frac{I_{LOAD}}{f_s \times C1} \times \frac{V_{OUT}}{V_{IN}} \times \left(1 - \frac{V_{OUT}}{V_{IN}}\right)$$

### Selecting the Output Capacitor

The output capacitor (C2) maintains the DC output voltage. Use ceramic, tantalum, or low-ESR electrolytic capacitors. Low ESR capacitors are preferred to keep the output

voltage ripple low. The output voltage ripple can be estimated by:

$$\Delta V_{OUT} = \frac{V_{OUT}}{f_s \times L_1} \times \left(1 - \frac{V_{OUT}}{V_{IN}}\right) \times \left(R_{ESR} + \frac{1}{8 \times f_s \times C_2}\right)$$

Where  $L_1$  is the inductor value and  $R_{ESR}$  is the equivalent series resistance of the output capacitor.

For ceramic capacitors, the capacitance dominates the impedance at the switching frequency. The capacitance also causes the majority of the output voltage ripple. For simplification, estimate the output voltage ripple with:

$$\Delta V_{OUT} = \frac{V_{OUT}}{8 \times f_s^2 \times L_1 \times C_2} \times \left(1 - \frac{V_{OUT}}{V_{IN}}\right)$$

For tantalum or electrolytic capacitors, the ESR dominates the impedance at the switching frequency. For simplification, the output ripple can be approximated to:

$$\Delta V_{OUT} = \frac{V_{OUT}}{f_s \times L_1} \times \left(1 - \frac{V_{OUT}}{V_{IN}}\right) \times R_{ESR}$$

The characteristics of the output capacitor also affect the stability of the regulation system. The MP1495 can be optimized for a wide range of capacitance and ESR values.

### External Bootstrap Diode

An external bootstrap diode can enhance the efficiency of the regulator, given the following conditions:

- $V_{OUT}$  is 5V or 3.3V; and
- Duty cycle is high:  $D = \frac{V_{OUT}}{V_{IN}} > 65\%$

In these cases, connect an external BST diode from the VCC pin to BST pin, as shown in Figure 5.

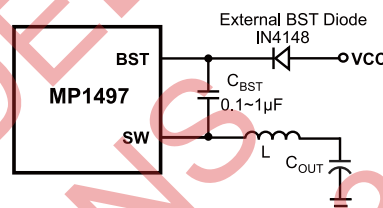

**Figure 5: Optional External Bootstrap Diode to Enhance Efficiency**

The recommended external BST diode is IN4148, and the BST capacitor is 0.1µF to 1µF.

### PC Board Layout<sup>(8)</sup>

PCB layout is very important to achieve stable operation especially for VCC capacitor and input capacitor placement. For best results, follow these guidelines:

- 1) Use large ground plane directly connect to GND pin. Add vias near the GND pin if bottom layer is ground plane.
- 2) Place the VCC capacitor to VCC pin and GND pin as close as possible. Make the trace length of VCC pin-VCC capacitor anode-VCC capacitor cathode-chip GND pin as short as possible.
- 3) Place the ceramic input capacitor close to IN and GND pins. Keep the connection of input capacitor and IN pin as short and wide as possible.
- 4) Route SW, BST away from sensitive analog areas such as FB. It's not recommended to route SW, BST trace under chip's bottom side.
- 5) Place the T-type feedback resistor R9 close to chip to ensure the trace which connects to FB pin as short as possible

#### Notes:

- 8) The recommended layout is based on the Figure 6 Typical Application circuit on the next page.

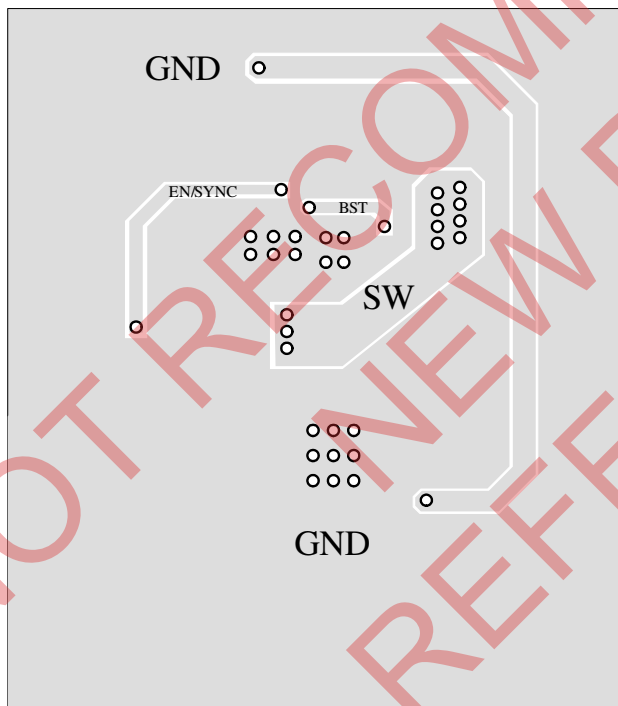
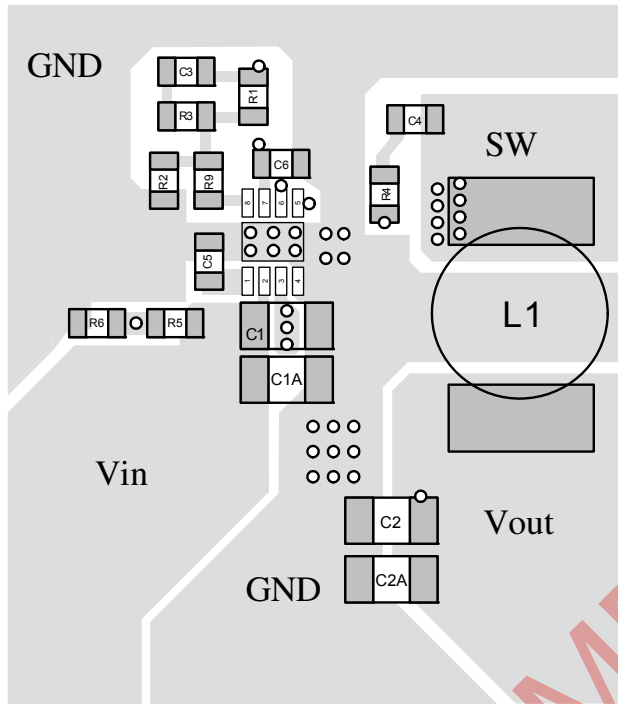

NOT RECOMMENDED FOR NEW DESIGNS REFER TO MP2333

**TYPICAL APPLICATION CIRCUITS**

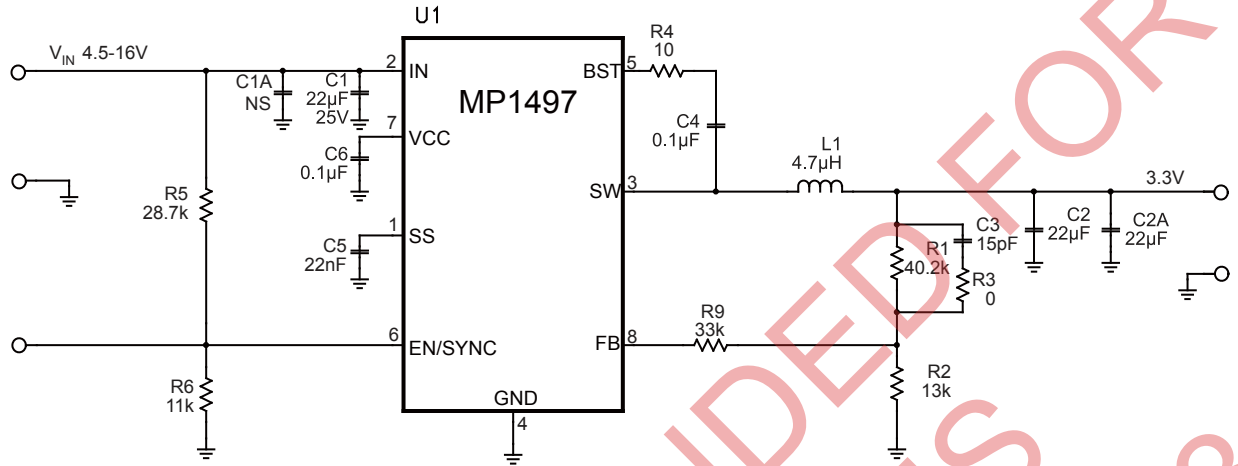
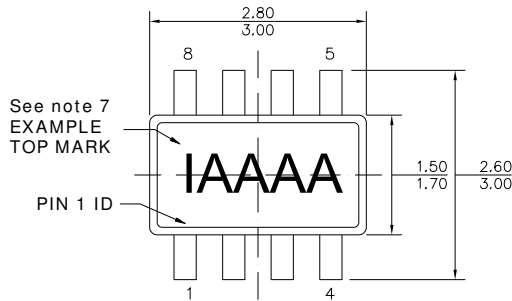

**Figure 6: 12V<sub>IN</sub>, 3.3V/3A**

NOT RECOMMENDED FOR NEW DESIGNERS REFER TO MP2333

**PACKAGE INFORMATION**

**TSOT23-8**



TOP VIEW

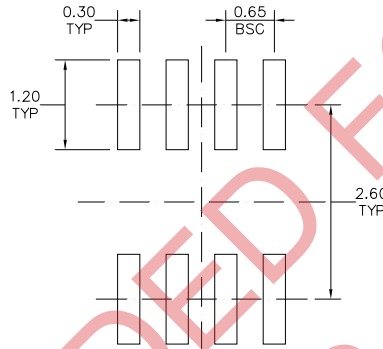

RECOMMENDED LAND PATTERN

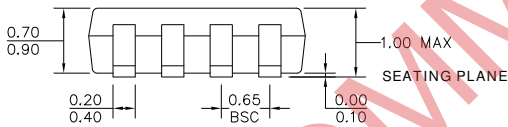

FRONT VIEW

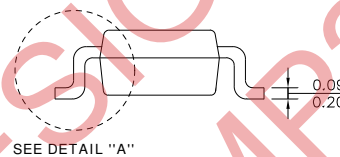

SIDE VIEW

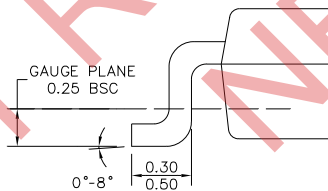

DETAIL "A"

**NOTE:**

- 1) ALL DIMENSIONS ARE IN MILLIMETERS.
- 2) PACKAGE LENGTH DOES NOT INCLUDE MOLD FLASH, PROTRUSION OR GATE BURR.
- 3) PACKAGE WIDTH DOES NOT INCLUDE INTERLEAD FLASH OR PROTRUSION.
- 4) LEAD COPLANARITY (BOTTOM OF LEADS AFTER FORMING) SHALL BE 0.10 MILLIMETERS MAX.
- 5) JEDEC REFERENCE IS MO-193, VARIATION BA.
- 6) DRAWING IS NOT TO SCALE.
- 7) PIN 1 IS LOWER LEFT PIN WHEN READING TOP MARK FROM LEFT TO RIGHT, (SEE EXAMPLE TOP MARK)

**NOTICE:** The information in this document is subject to change without notice. Users should warrant and guarantee that third party Intellectual Property rights are not infringed upon when integrating MPS products into any application. MPS will not assume any legal responsibility for any said applications.