

## Miniature Battery Connectors

## XD2B

Miniature Battery Connectors  
with 13.2 mm Width and  
2.6 mm Depth

- Greatly reduced board footprint with a depth of 2.6 mm.
- Use for mid mount board, height on PCB 1.4 mm.
- Three models available for different battery connection applications.

**NEW**

## Model Number Legend

XD2B-□□□□-□□□□  
(1) (2) (3) (4)

(1) Number of Pads

Code	Number of Pads
04	4
05	5

(2) Number of contact pins

Code	Pins
06	6 Pins
07	7 Pins
08	8 Pins

(3) Pad Pitch

Code	Pitch
20	2.0 mm
23	2.3 mm
26	2.65 mm

(4) Plating

Code	Plating
A	Au

## Ratings and Characteristics

Rated current *1	XD2B-0406-26A	2A
	XD2B-0507-20A	
	XD2B-0408-23A	3A
Rated voltage	5 VDC	
Contact resistance *2	1 Pin : 70 mΩ max.	
	2 Pins : 35 mΩ max.	
	3 Pins : 35 mΩ max.	
Operation durability	5000 times min.	
Operating temperature	-30 to 85°C (with no condensation or icing)	

\*1. The rated current assumes that the end pins (▲) are used as the power lines.

\*2. The contact resistance of pins marked ▲ is 35 mΩ. The contact resistance of the other pins is 70 mΩ.









## Materials and Finish

Housing	LCP resin (UL94 V-0) / black
Contacts	Nickel alloy / nickel base, gold plated
Hold-down	Brass / nickel base, gold plated

# XD2B

## Ordering Information

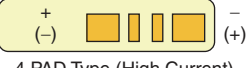
Model	Appearance	Number of Pads	Number of contact pins	Battery PAD	Quantity per reel (unit) *
XD2B-0406-26A		4	6	 4 PAD Type	 2,000
XD2B-0507-20A		5	7	 5 PAD Type	
XD2B-0408-23A		4	8	 4 PAD Type (High Current)	

\* Order in integer multiples of the quantity per reel.

## Dimensions

(Unit: mm)

### XD2B-0406-26A

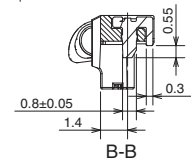
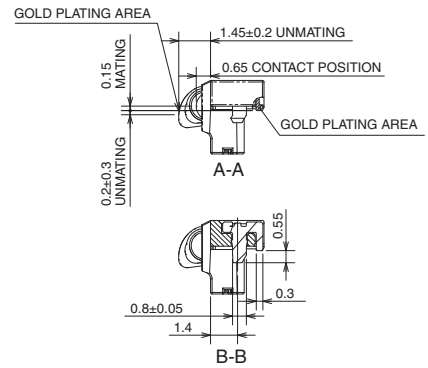
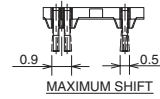
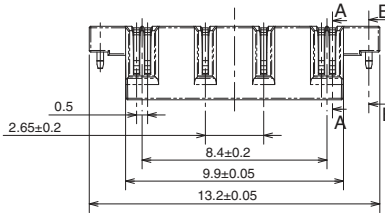
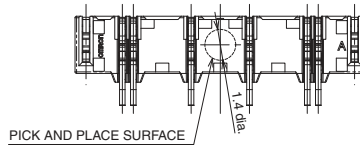
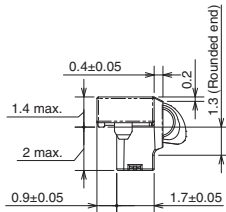

### PCB Mating Dimensions (TOP VIEW)

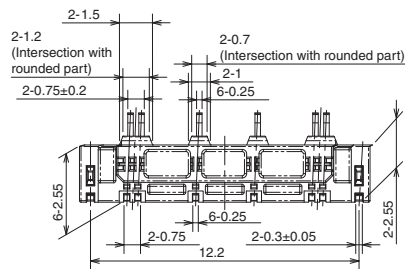
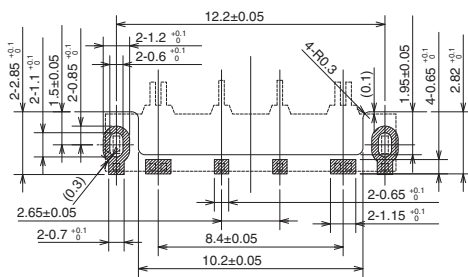

### Reference Pad Dimensions

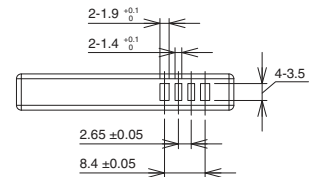

### Precautions

1. Coplanarity: 0.1 max.
2. Tolerance: ±0.1 unless otherwise specified.

XD2B-0507-20A

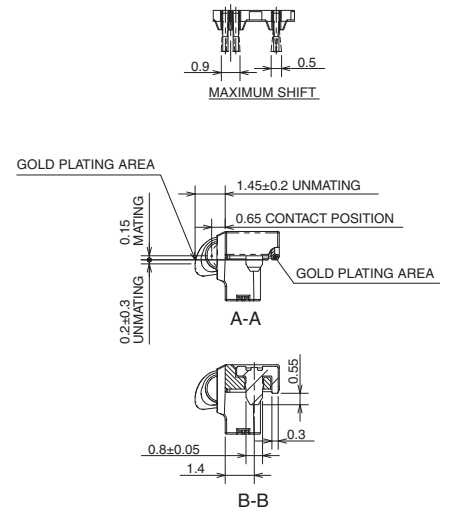
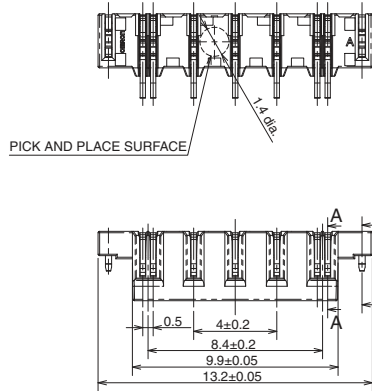
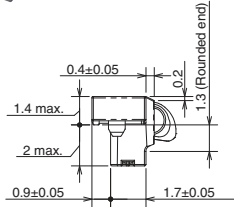

PCB Mating Dimensions (TOP VIEW)

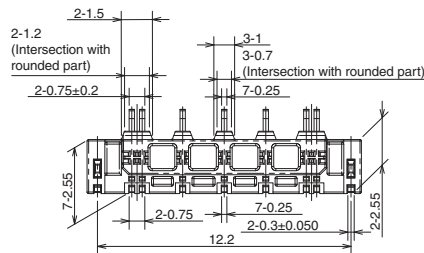
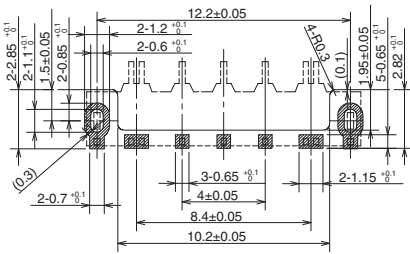

Reference Pad Dimensions

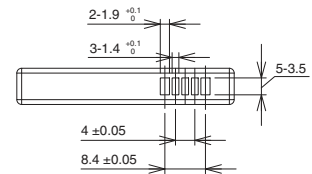

Precautions

1. Coplanarity: 0.1 max.
2. Tolerance: ±0.1 unless otherwise specified.

XD2B-0408-23A

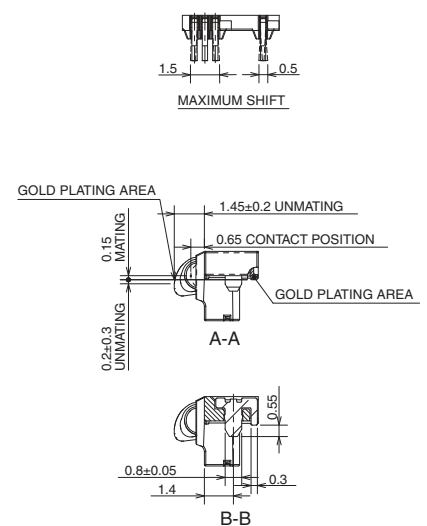
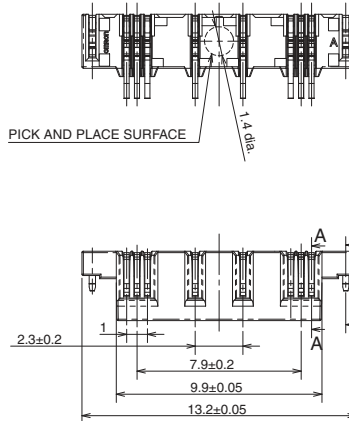
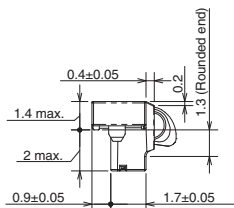

PCB Mating Dimensions (TOP VIEW)

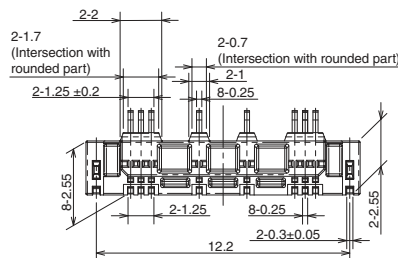
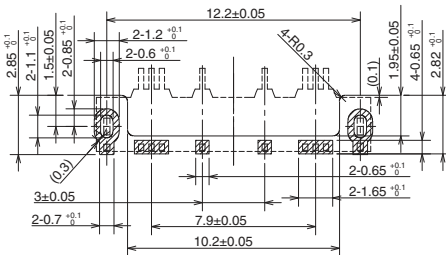

Reference Pad Dimensions

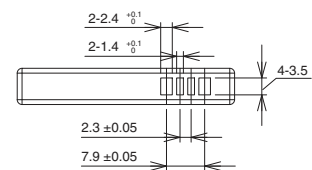

Precautions

1. Coplanarity: 0.1 max.
2. Tolerance: ±0.1 unless otherwise specified.

# XD2B

## Safety Precautions

### Precautions for Correct Use

#### •For Operating

- (1) Do not apply excessive force to the contacts. Doing so may cause the contacts to deform or the contact plating to peel, resulting in contact failure.
- (2) Do not touch contacts directly with your fingers or other parts of your body. Doing so may cause the contacts to deform, resulting in contact failure.

#### •For Designing

- (1) Design the case so that the contacts are not subject to a load from the top when the battery is inserted. Not doing so may cause the contacts to deform, resulting in contact failure.

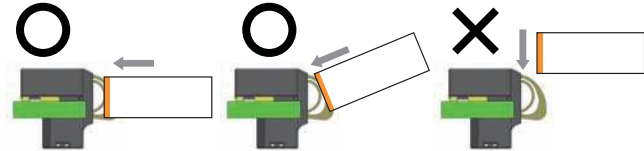

- (2) Use the following specifications for the plating on the battery pad surface: nickel base with gold plating of a thickness of 1.5  $\mu\text{m}$  or greater.
- (3) Use a metal mask thickness of between 0.12 to 0.15 mm. The recommended metal mask opening ratio is 90% of the processing dimensions on the PCB in the external dimensions diagram.
- (4) Design the case so that the contacts are located as shown in the outline drawing when the battery is mated.

#### •For Mounting

- (1) Use reflow conditions that are within the ranges specified by OMRON. However, reflow conditions depend on the type of solder, manufacturer, quantity, board size, and other mounting materials and conditions. Always confirm mounting conditions before actual application.
- (2) Do not mount the Connectors with manual soldering. If the end of the soldering iron comes into contact with the Connector, deformation may result.
- (3) Do not perform the following operations during mounting. Doing so may damage the Connector, resulting in contact failure or mounting failure.
  - Stack boards to which the Connectors are mounted.
  - Touch the contact section or hold-downs with tweezers or other objects.
  - Apply outward force on the contact sections.

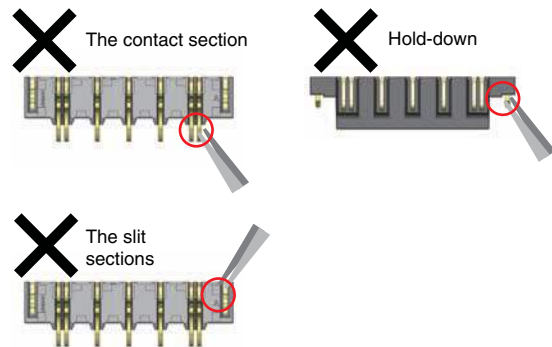

• Application examples provided in this document are for reference only. In actual applications, confirm equipment functions and safety before using the product.  
• Consult your OMRON representative before using the product under conditions which are not described in the manual or applying the product to nuclear control systems, railroad systems, aviation systems, vehicles, combustion systems, medical equipment, amusement machines, safety equipment, and other systems or equipment that may have a serious influence on lives and property if used improperly. Make sure that the ratings and performance characteristics of the product provide a margin of safety for the system or equipment, and be sure to provide the system or equipment with double safety mechanisms.

**Note: Do not use this document to operate the Unit.**