



**SPECIFICATION SHEET**

<b>SPECIFICATION SHEET NO.</b>	P1102- SOD123F4004SD4
<b>DATE</b>	Nov. 02, 2022
<b>REVISION</b>	A0
<b>DESCRIPTION</b>	SMD General Purpose Silicon Rectifier, SOD-123FL series, SOD4004 Type, 2 Pads Reverse Voltage 400V Max. Forward Current 1.0A Max. Operating Temp. Range -55°C ~+150°C Package in Tape/Reel, 3000pcs/Reel RoHS/RoHS III compliant
<b>CUSTOMER</b>	
<b>CUSTOMER PART NUMBER</b>	
<b>CROSS REF. PART NUMBER</b>	
<b>ORIGINAL PART NUMBER</b>	MDD SOD4004
<b>PART CODE</b>	SOD123F4004SD4

<b>VENDOR APPROVE</b>		
Issued/Checked/Approved		
		
DATE: Nov. 02, 2022		

<b>CUSTOMER APPROVE</b>	
DATE:	

11/2/2022

**SMD GENERAL PURPOSE RECTIFIER SOD123FL SERIES**



**MAIN FEATURE**

- Glass Passivated Device
- Ideal For SMT Applications
- Low Reverse Leakage
- Metallurgically Bonded Construction
- High Temperature Soldering Guaranteed:  
250°C/10 Seconds, 0.375”(9.5mm) Lead Length, 5 Lbs. (2.3kg) Tension

**APPLICATION**

- For printed circuit board

**RFQ**

[Request For Quotation](#)

**PART CODE GUIDE**

SOD123F	4004	S	D4
1	2	3	4

- 1) **SOD123F**: SMD General Purpose Silicon Rectifier, SOD-123FL series,
- 2) **4004**: Type Code for original part number SOD4004
- 3) **S**: Package code, Tape/reel, 3000pcs/reel.
- 4) **D4**: Marking code for “D4” on the case surface, Different Marking for different specification..

**MORE ITEMS AVAILABLE**

SOD123F4001SD1	SOD123F4002SD2	SOD123F4003SD3	<b>SOD123F4004SD4</b>	SOD123F4005SD5
SOD123F4006SD6	SOD123F4007SD7			

**SMD GENERAL PURPOSE RECTIFIER SOD123FL SERIES**

**DIMENSION (Unit: Inch/mm)**

Image for reference



Marking: D4

SOD-123FL

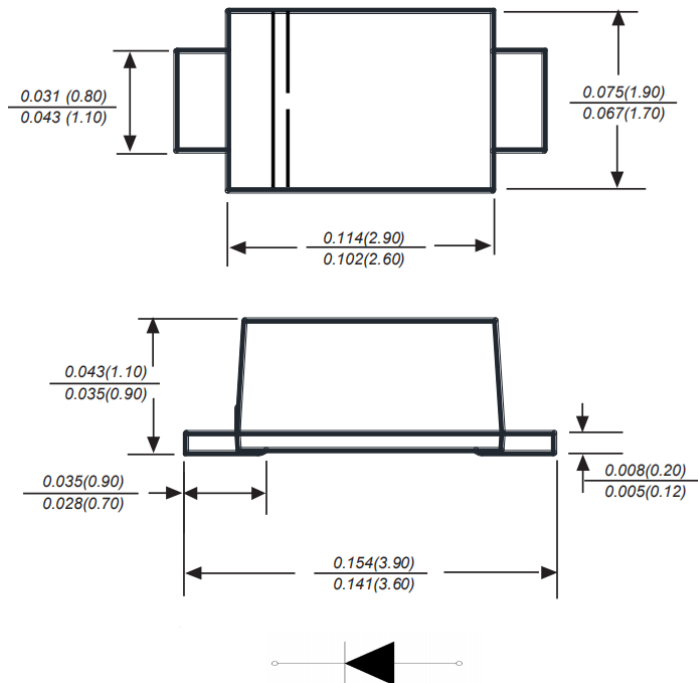

Recommend Pad Layout

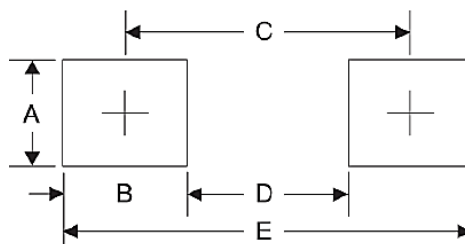

Symbol	Unit (Inch)	Unit (mm)
A	0.047	1.20
B	0.047	1.20
C	0.126	3.20
D	0.079	2.00
E	0.173	4.40

**SMD GENERAL PURPOSE RECTIFIER SOD123FL SERIES**
**MECHANICAL DATA**

Case	Terminals	Polarity	Mounting Position	Weight per piece
JEDEC SOD-123FL molded plastic body	Solder plated, Solderable per MIL-STD-750, Method 2026	Polarity symbol marking on body	Any	0.0007 Ounce, 0.020 grams

**MAX. RATING & CHARACTERISTICS**

Parameter	SYMBOLS	VALUE			UNITS
		Min.	Typical	Max.	
<b>Repetitive peak reverse voltage</b>	V <sub>RRM</sub>			400	Volts
<b>RMS voltage</b>	V <sub>RMS</sub>			280	Volts
<b>DC blocking voltage</b>	V <sub>DC</sub>			400	Volts
<b>Average forward output rectified current</b>	I <sub>AV</sub>			1.0	A
<b>Peak forward surge current 8.3ms single half sine-wave superimposed on rated load (JEDEC Method)</b>	I <sub>FSM</sub>			30	A
<b>Instantaneous forward voltage at 1.0A</b>	V <sub>F</sub>			1.1	Volts
<b>DC reverse current at rated DC blocking voltage</b>	I <sub>R</sub>			5.0	μA
				50	μA
<b>Junction capacitance (Note 2)</b>	C <sub>J</sub>		8		pF
<b>Thermal resistance (Note 3)</b>	R <sub>QJA</sub>		90		°C/W
<b>Operating junction temperature range</b>	T <sub>J</sub>	-55		+150	°C
<b>Storage temperature range</b>	T <sub>STG</sub>	-55		+150	°C

**Note**

- Ratings at 25 C ambient temperature unless otherwise specified. Single phase half-wave 60Hz, resistive or inductive load, for capacitive load current derate by 20%.
- Averaged over any 20ms period.
- Measured at 1.0MHz and applied reverse voltage of 4.0Voltage
- Thermal resistance from junction to ambient at 0.375" (9.5mm)lead length, P.C.B. mounted

11/2/2022

**SMD GENERAL PURPOSE RECTIFIER SOD123FL SERIES**
**RELIABILITY**

Number	Experiment Items	Experiment Method And Conditions	Reference Documents
1	Solder Resistance Test	Test 260°C± 5°C for 10 ± 2 sec. Immerse body into solder 1/16" ± 1/32"	MIL-STD-750D METHOD-2031.2
2	Solderability Test	230°C ±5°C for 5 sec.	MIL-STD-750D METHOD-2026.1 0
3	Pull Test	1 kg in axial lead direction for 10 sec.	MIL-STD-750D METHOD-2036.4
4	Bend Test	0.5Kg Weight Applied To Each Lead, Bending Arcs 90 °C ± 5 °C For 3 Times	MIL-STD-750D METHOD-2036.4
5	High Temperature Reverse Bias Test	TA=100°C for 1000 Hours at VR=80% Rated VR	MIL-STD-750D METHOD-1038.4
6	Forward Operation Life Test	TA=25°C Rated Average Rectified Current	MIL-STD-750D METHOD-1027.3
7	Intermittent Operation Life Test	On state: 5 min with rated IRMS Power Off state: 5 min with Cool Forced Air. On and off for 1000 cycles.	MIL-STD-750D METHOD-1036.3
8	Pressure Cooker Test	15 PSIG, TA=121°C, 4 hours	MIL-S-19500 APPENOIXC
9	Temperature Cycling Test	-55°C~+125°C; 30 Minutes For Dwelled Time 5 minutes for transferred time. Total: 10 cycles.	MIL-STD-750D METHOD-1051.7
10	Thermal Shock Test	0°C for 5 minutes., 100°C for 5minutes, Total: 10 cycles	MIL-STD-750D METHOD-1056.7
11	Forward Surge Test	8.3ms Single Sale Sine-wave One Surge.	MIL-STD-750D METHOD-4066.4
12	Humidity Test	TA=65°C, RH=98% for 1000 hours.	MIL-STD-750D METHOD-1021.3
13	High Temperature Storage life Test	150°C for 1000 Hours	MIL-STD-750D METHOD-1031.5

**SMD GENERAL PURPOSE RECTIFIER SOD123FL SERIES**

**SUGGESTED REFLOW PROFILE (For Reference Only)**

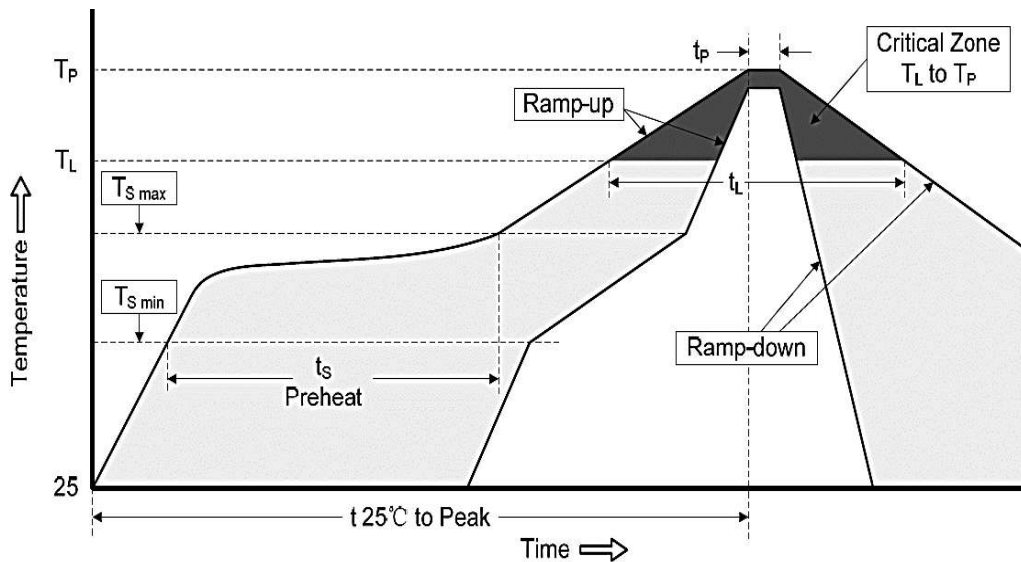

<b>Profile Feature</b>		Pb-Free Assembly
<b>Average Ramp-up Rate (Ts Max to Tp)</b>		3°C/second Max
<b>Preheat</b>	<b>Temperature Min (Ts Min.)</b>	150°C
	<b>Temperature Max (Ts Max.)</b>	200°C
	<b>Time (ts Min. to ts Max.)</b>	60 ~ 180 seconds
<b>Time maintained above</b>	<b>Temperature (Tl)</b>	217°C
	<b>Time (tl)</b>	60 ~ 150 seconds
<b>Peak/Classification Temperature (Tp)</b>		260 °C
<b>Time within 5°C of actual Peak Temperature (tp)</b>		20 ~ 40 seconds
<b>Ramp-down rate</b>		6 °C /Second Max.
<b>Time 25 °C to Peak Temperature</b>		8 minutes Max.
<b>Suggest reflow times</b>		3 Times Max.

**SMD GENERAL PURPOSE RECTIFIER SOD123FL SERIES**

**RATINGS AND CHARACTERISTIC CURVES (For Reference Only)**

Fig.1 Forward Current Derating Curve

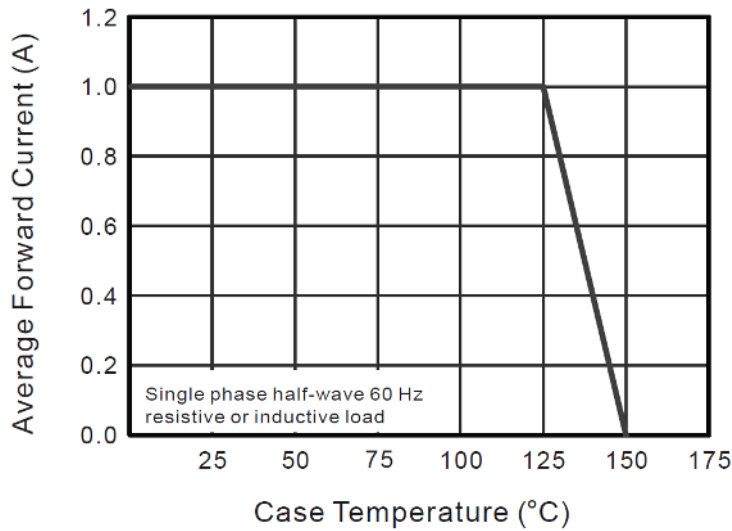
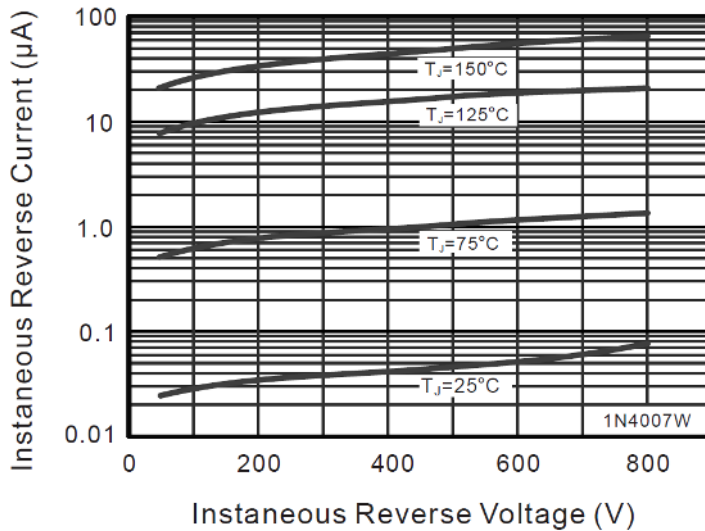

Fig.2 Typical Instaneous Reverse Characteristics



**SMD GENERAL PURPOSE RECTIFIER SOD123FL SERIES**

**RATINGS AND CHARACTERISTIC CURVES (For Reference Only)**

**Fig.3 Typical Forward Characteristic**

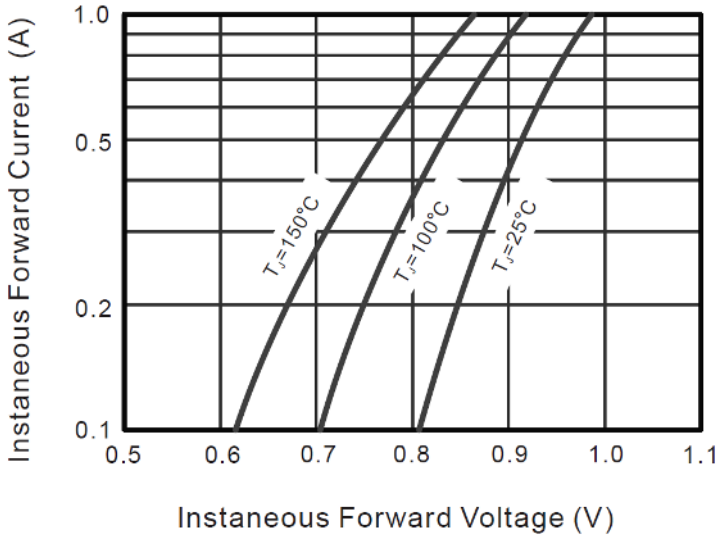

**Fig.4 Typical Junction Capacitance**

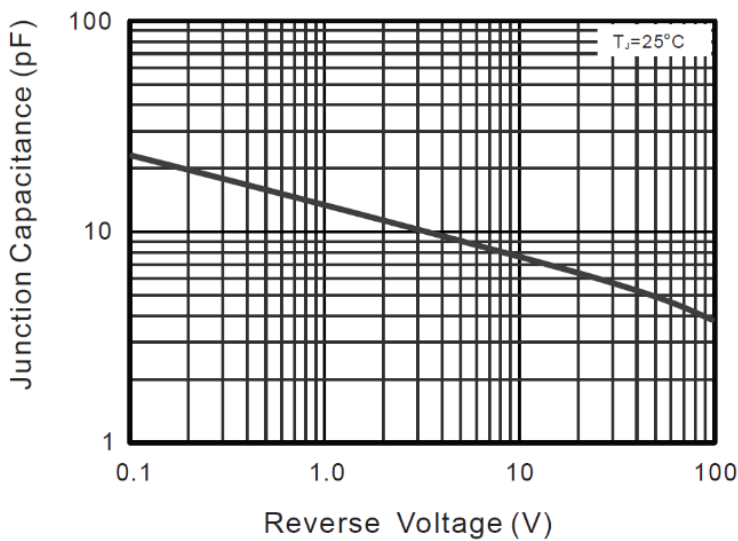



**SMD GENERAL PURPOSE RECTIFIER SOD123FL SERIES**

**RATINGS AND CHARACTERISTIC CURVES (For Reference Only)**

Fig.5 Maximum Non-Repetitive Peak Forward Surge Current

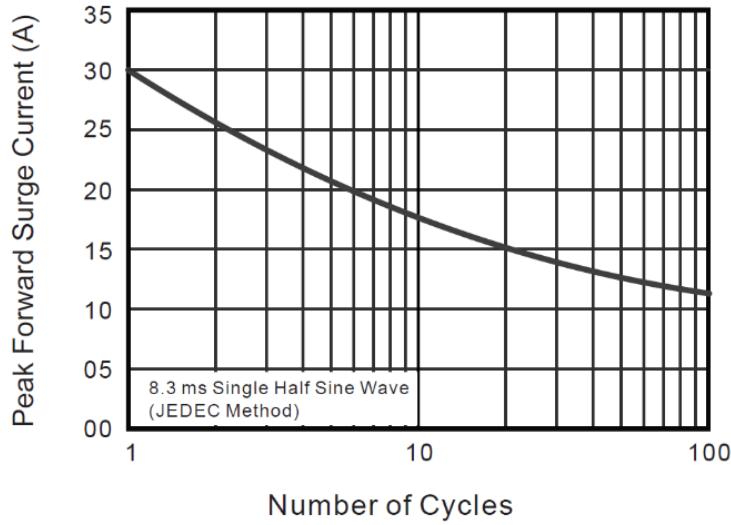

**SMD GENERAL PURPOSE RECTIFIER SOD123FL SERIES**

**TAPE/REEL (Unit: mm)**

All Devices are packed in accordance with EIA standard RS-481-A and specifications.

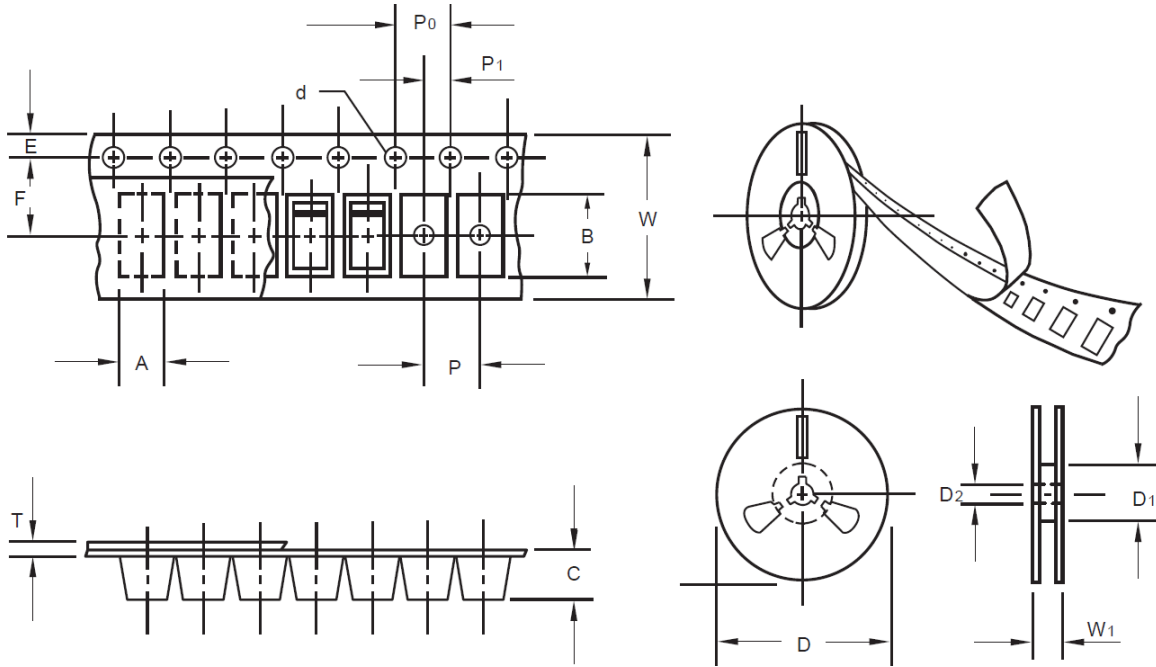

Item	Symbol	Tolerance	SOD-123FL
Carrier width	A	0.1	2.10
Carrier Length	B	0.1	4.00
Carrier Depth	C	0.1	1.60
Sprocket hole	d	0.05	1.55
7"Reel outside diameter	D	2.0	178.00
7"Reel inner diameter	D1	Min.	50.00
Feed hole diameter	D2	0.5	13.00
Sprocket hole position	E	0.1	1.75
Punch hole position	F	0.1	3.50
Punch hole pitch	P	0.1	4.00
Sprocket hole pitch	P0	0.1	4.00
Embossment center	P1	0.1	2.00
Overall tape thickness	T	0.1	0.25
Tape width	W	0.3	8.15
Reel width	W1	1.0	10.50

**SMD GENERAL PURPOSE RECTIFIER SOD123FL SERIES**

**PACKAGE For Reference**

<b>Case Code</b>	SOD-123FL
Reel Size	7"
Reel Size	178 mm
MPQ/Reel	3000 pcs
Qty. /Box	6000 pcs
G.W/Box	1 lbs

**IMPORTANT NOTICE AND DISCLAIMER**

- 1) NextGen Component, Inc. reserves the right to make changes to this document and its products and specifications at any time without notice. Customers should obtain and confirm the latest product information and specifications before final design, purchase or use.
- 2) NextGen Component, Inc makes no warranty, representation or guarantee regarding the suitability of its products for any particular purpose, nor does NextGen Component, Inc assume any liability for application assistance or customer product design.
- 3) NextGen Component, Inc does not warrant or accept any liability with products which are purchased or used for any unintended or unauthorized application. No license is granted by implication or otherwise under any intellectual property rights of NextGen Component, Inc
- 4) NextGen Component, Inc. products are not authorized for use as critical components in life support devices or systems without express written approval of NextGen Component, Inc.