

Aluminum Electrolytic Capacitors SMD (Chip) Long Life



Fig. 1

RoHS
COMPLIANT

FEATURES

- Useful life: 2000 h at 105 °C
- Flexible terminals, reflow and wave solderable
- Compact, rectangular shape
- Charge and discharge proof, no peak current limitation
- Polarized aluminum electrolytic capacitors, non-solid electrolyte, self healing
- Extended voltage and capacitance range
- SMD-version, fully molded, insulated
- Supplied in blister tape on reel
- Material categorization: for definitions of compliance please see www.vishay.com/doc?99912

APPLICATIONS

- SMD technology
- Industrial and professional applications
- Telecommunications, automotive, EDP general industrial
- Coupling, decoupling, smoothing, filtering, buffering, timing

MARKING

- Rated capacitance (in μF)
- Rated voltage (in V)
- Date code in accordance with IEC 60062
- Name of manufacturer
- “-” sign indicating the cathode. The anode is identified by bevelled edges
- Series number (139)

QUICK REFERENCE DATA	
DESCRIPTION	VALUE
Nominal case sizes (L x W x H in mm)	14.3 x 6.2 x 6.9 and 14.3 x 7.6 x 8.2
Rated capacitance range, C_R	1.0 μF to 220 μF
Tolerance on C_R	$\pm 20\%$
Rated voltage range, U_R	6.3 V to 100 V
Category temperature range	-55 °C to +105 °C
Endurance test at 105 °C	1000 h
Useful life at 105 °C	2000 h
Useful life at 40 °C; 1.3 x I_R applied	200 000 h
Shelf life at 0 V, 105 °C	500 h
Resistance to soldering heat test	Immersion in solder: 10 s at 260 °C or 40 s at 215 °C
Based on sectional specification	IEC 60384-18 / CECC 32300
Climatic category IEC 60068	55 / 105 / 56

SELECTION CHART FOR C_R , U_R , AND RELEVANT NOMINAL CASE SIZES (L x W x H in mm)								
C_R (μF)	U_R (V)							
	6.3	10	16	25	40	50	63	100
1.0	-	-	-	-	-	-	-	14.3 x 6.2 x 6.9
2.2	-	-	-	-	-	-	14.3 x 6.2 x 6.9	14.3 x 6.2 x 6.9
3.3	-	-	-	-	-	-	14.3 x 6.2 x 6.9	14.3 x 7.6 x 8.2
4.7	-	-	-	-	-	-	14.3 x 6.2 x 6.9	14.3 x 7.6 x 8.2
10	-	-	-	14.3 x 6.2 x 6.9	-	14.3 x 6.2 x 6.9	14.3 x 7.6 x 8.2	-
15	-	-	-	-	14.3 x 6.2 x 6.9	14.3 x 7.6 x 8.2	-	-
22	-	-	-	14.3 x 6.2 x 6.9	-	14.3 x 7.6 x 8.2	-	-
33	-	-	-	-	14.3 x 7.6 x 8.2	-	-	-

SELECTION CHART FOR C_R , U_R , AND RELEVANT NOMINAL CASE SIZES (L x W x H in mm)								
C_R (μF)	U_R (V)							
	6.3	10	16	25	40	50	63	100
47	-	-	14.3 x 6.2 x 6.9	14.3 x 7.6 x 8.2	-	-	-	-
68	-	14.3 x 6.2 x 6.9	-	-	-	-	-	-
100	14.3 x 6.2 x 6.9	-	14.3 x 7.6 x 8.2	-	-	-	-	-
150	-	14.3 x 7.6 x 8.2	-	-	-	-	-	-
220	14.3 x 7.6 x 8.2	-	-	-	-	-	-	-

DIMENSIONS in millimeters

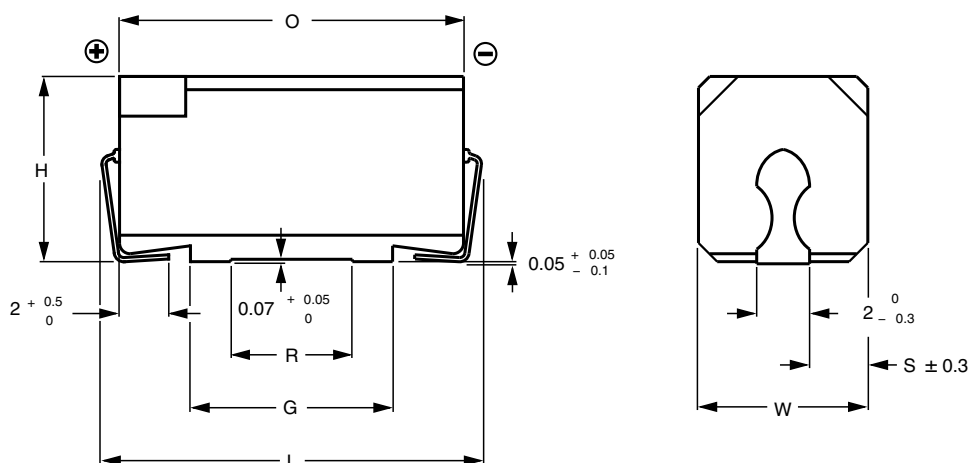

Fig. 2 - Dimensional outline

Table 1

DIMENSIONS in millimeters, MASS AND PACKAGING QUANTITIES										
NOMINAL CASE SIZE L x W x H	CASE CODE	$L_{max.}$	$W_{max.}$	$H_{max.}$	$O_{max.}$	S	$G_{max.}$	$R_{min.}$	MASS (g)	PACKAGING QUANTITIES PER REEL
14.3 x 6.2 x 6.9	2	14.5	6.3	7.05	13.0	2.15	7.5	4.7	≈ 0.95	700
14.3 x 7.6 x 8.2	3	14.5	7.7	8.35	13.0	2.85	7.5	4.7	≈ 1.3	700

Note

- For detailed tape dimensions please see www.vishay.com/doc?28359



Table 2

RECOMMENDED SOLDERING PAD DIMENSIONS in millimeters (placement accuracy ± 0.25 mm)														
NOMINAL CASE SIZE L x W x H	FOR REFLOW SOLDERING							FOR WAVE SOLDERING						
	A	B	C	D	E	F	G	A	B	C	D	E	F	G
14.3 x 6.2 x 6.9	15.8	8.8	3.5	2.8	8.0	16.2	7.7	18.6	10.0	4.3	5.0	8.8	20.5	11.5
14.3 x 7.6 x 8.2	15.8	8.8	3.5	2.8	8.0	16.2	9.1	18.6	10.0	4.3	6.0	8.8	21.5	13.0

MOUNTING

The capacitors are designed for automatic placement on to printed-circuit boards or hybrid circuits.

Optimum dimensions of soldering pads depend amongst others on soldering method, mounting accuracy, print lay-out and / or adjacent components.

For recommended soldering pad dimensions, refer to Fig. 3 and Table 2.

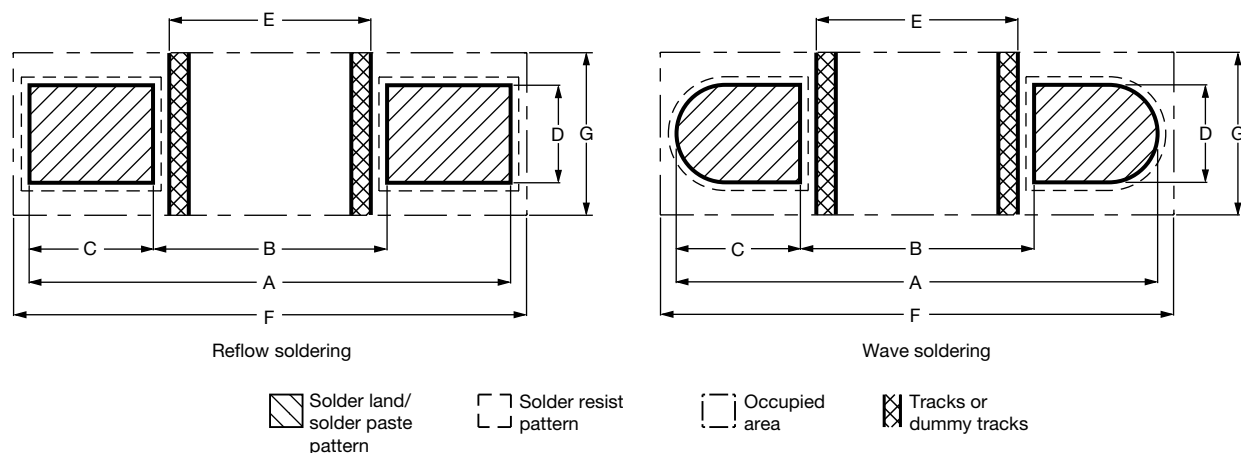

Fig. 3 - Recommended pad dimensions for reflow and wave soldering

SOLDERING

Soldering conditions are defined by the curve, temperature versus time, where the temperature is that measured on the soldering pad during processing.

For maximum conditions of different soldering methods see Fig. 4, 5, and 6.

Any temperature versus time curve which does not exceed the specified maximum curves may be applied.

AS A GENERAL PRINCIPLE, TEMPERATURE AND DURATION SHALL BE THE **MINIMUM** NECESSARY REQUIRED TO ENSURE GOOD SOLDERING CONNECTIONS. HOWEVER, THE SPECIFIED MAXIMUM CURVES SHOULD NEVER BE EXCEEDED.

Table 3

CURING CONDITIONS FOR SMD-GLUE	
MAX. T _{amb} (°C)	MAX. EXPOSURE TIME (min)
125	30
140	10
150	5
160	2
160	2

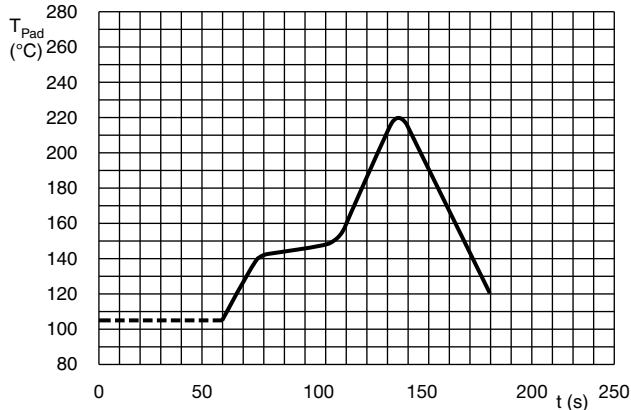

Fig. 4 - Maximum temperature load during infrared reflow soldering

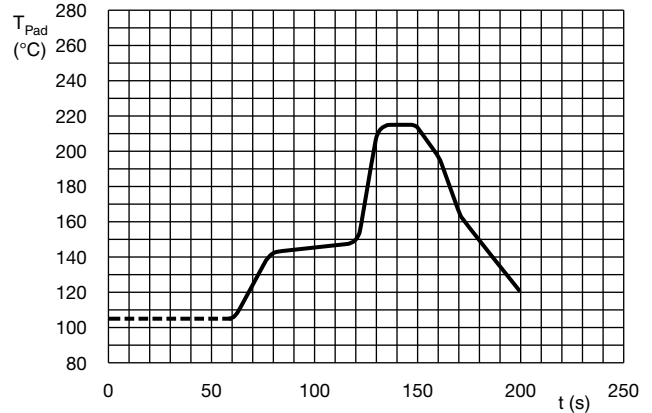

Fig. 5 - Maximum temperature load during vapor phase reflow soldering

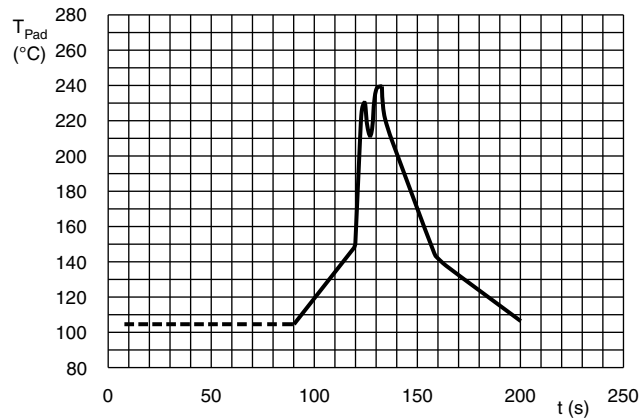

Fig. 6 - Maximum temperature load during (double-) wave soldering

ELECTRICAL DATA	
SYMBOL	DESCRIPTION
C_R	Rated capacitance at 100 Hz, tolerance $\pm 20\%$
I_R	Rated RMS ripple current at 100 Hz, 105 °C
I_{L5}	Max. leakage current after 5 min at U_R
$\tan \delta$	Max. dissipation factor at 100 Hz
Z	Max. impedance at 10 kHz

Note

- Unless otherwise specified, all electrical values in Table 4 apply at $T_{amb} = 20\text{ °C}$, $P = 86\text{ kPa}$ to 106 kPa , $RH = 45\%$ to 75% .

ORDERING EXAMPLE

Electrolytic capacitor 139 series
 100 μF / 16 V; $\pm 20\%$
 Nominal case size: 14.3 mm x 7.6 mm x 8.2 mm
 Taped on reel
 Ordering code: MAL213965101E3
 Former 12NC: 2222 139 65101



Table 4

ELECTRICAL DATA AND ORDERING INFORMATION							
U_R (V)	C_R 100 Hz (μ F)	NOMINAL CASE SIZE L x W x H (mm)	I_R 100 Hz 105 °C (mA)	I_{L5} 5 min (μ A)	$\tan \delta$ 100 Hz	Z 10 kHz (Ω)	ORDERING CODE MAL2139.....
6.3	100	14.3 x 6.2 x 6.9	79	4.3	0.24	3.0	63101E3
	220	14.3 x 7.6 x 8.2	120	5.8	0.24	1.4	63221E3
10	68	14.3 x 6.2 x 6.9	71	4.4	0.20	2.9	64689E3
	150	14.3 x 7.6 x 8.2	110	6.0	0.20	1.3	64151E3
16	47	14.3 x 6.2 x 6.9	66	4.5	0.16	3.4	65479E3
	100	14.3 x 7.6 x 8.2	100	6.2	0.16	1.6	65101E3
25	10	14.3 x 6.2 x 6.9	40	3.5	0.09	12	66109E3
	22	14.3 x 6.2 x 6.9	48	4.1	0.14	5.5	66229E3
	47	14.3 x 7.6 x 8.2	79	5.4	0.14	2.6	66479E3
40	15	14.3 x 6.2 x 6.9	45	4.2	0.11	6	67159E3
	33	14.3 x 7.6 x 8.2	75	5.6	0.11	2.7	67339E3
50	10	14.3 x 6.2 x 6.9	40	4.0	0.09	7	61109E3
	15	14.3 x 7.6 x 8.2	56	4.5	0.09	4.7	61159E3
	22	14.3 x 7.6 x 8.2	67	5.2	0.09	3.2	61229E3
63	2.2	14.3 x 6.2 x 6.9	19	3.3	0.09	25	68228E3
	3.3	14.3 x 6.2 x 6.9	23	3.4	0.09	21	68338E3
	4.7	14.3 x 6.2 x 6.9	28	3.6	0.09	17	68478E3
	10	14.3 x 7.6 x 8.2	48	4.3	0.08	8	68109E3
100	1.0	14.3 x 6.2 x 6.9	12	3.2	0.09	55	69108E3
	2.2	14.3 x 6.2 x 6.9	19	3.4	0.09	29	69228E3
	3.3	14.3 x 7.6 x 8.2	27	3.7	0.08	17	69338E3
	4.7	14.3 x 7.6 x 8.2	33	3.9	0.08	11	69478E3

ADDITIONAL ELECTRICAL DATA		
PARAMETER	CONDITIONS	VALUE
Voltage		
Surge voltage for short periods		$U_s \leq 1.15 \times U_R$
Reverse voltage		$U_{rev} \leq 1 \text{ V}$
Current		
Leakage current	After 1 min at U_R	$I_{L1} \leq 0.02 C_R \times U_R + 3 \mu\text{A}$
	After 5 min at U_R	$I_{L5} \leq 0.002 C_R \times U_R + 3 \mu\text{A}$
Inductance		
Equivalent series inductance (ESL)	Nominal case size 14.3 mm x 6.2 mm x 6.9 mm	Typ. 18 nH
	Nominal case size 14.3 mm x 7.6 mm x 8.2 mm	Typ. 28 nH
Resistance		
Equivalent series resistance (ESR)	Calculated from $\tan \delta_{max.}$ and C_R (see Table 4)	$ESR = \tan \delta / 2 \pi f C_R$



CAPACITANCE

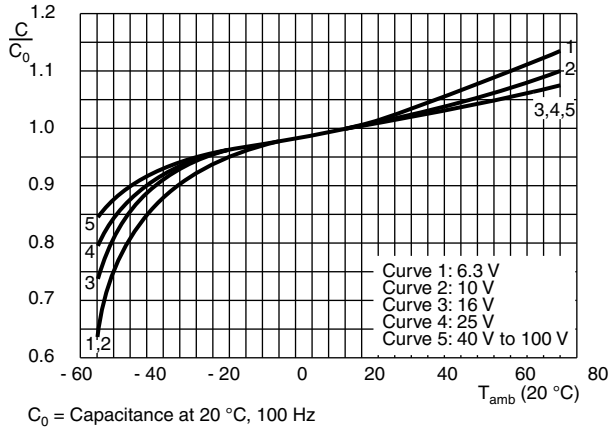

Fig. 7 - Typical multiplier of capacitance as a function of ambient temperature

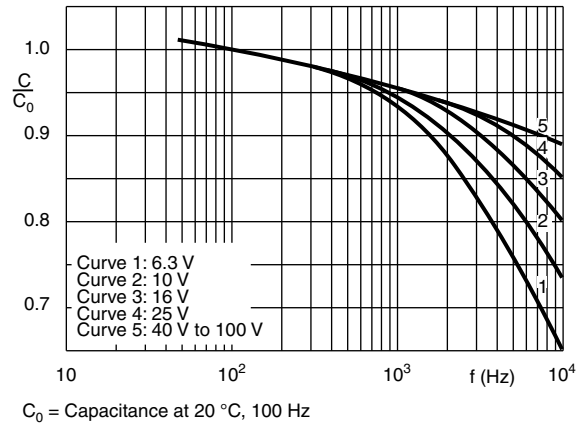

Fig. 8 - Typical multiplier of capacitance as a function of frequency

RIPPLE CURRENT AND USEFUL LIFE

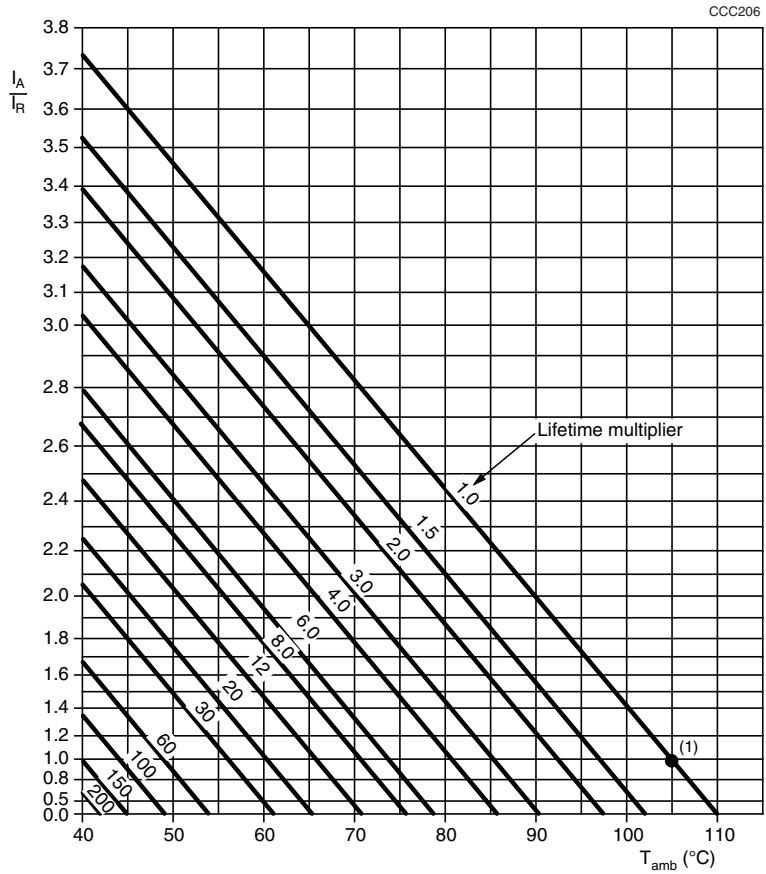

Fig. 9 - Multiplier of useful life as a function of ambient temperature and ripple current load



MULTIPLIER OF RIPPLE CURRENT (I_R) AS A FUNCTION OF FREQUENCY			
FREQUENCY (Hz)	I_R MULTIPLIER		
	$U_R = 6.3 \text{ V TO } 16 \text{ V}$	$U_R = 25 \text{ V TO } 50 \text{ V}$	$U_R = 63 \text{ V TO } 100 \text{ V}$
50	0.95	0.90	0.85
100	1.00	1.00	1.00
300	1.07	1.12	1.20
1000	1.12	1.20	1.30
3000	1.15	1.25	1.35
$\geq 10\,000$	1.20	1.30	1.40

Table 5

TEST PROCEDURES AND REQUIREMENTS			
TEST		PROCEDURE (quick reference)	REQUIREMENTS
NAME OF TEST	REFERENCE		
Mounting	IEC 60384-18, subclause 4.3	Shall be performed prior to tests mentioned below; reflow or (double-) wave soldering; for maximum temperature load refer to chapter "Mounting"	$\Delta C/C: \pm 5 \%$ $\tan \delta \leq \text{spec. limit}$ $I_{L5} \leq \text{spec. limit}$
Endurance	IEC 60384-18 / CECC 32300, subclause 4.15	$T_{\text{amb}} = 105 \text{ }^\circ\text{C}$; U_R applied; 1000 h	$U_R \leq 6.3 \text{ V } \Delta C/C: +15 \% / -30 \%$ $U_R \geq 10 \text{ V } \Delta C/C: \pm 15 \%$ $\tan \delta \leq 1.3 \times \text{spec. limit}$ $Z \leq 2 \times \text{spec. limit}$ $I_{L5} \leq \text{spec. limit}$
Useful life	CECC 30301, subclause 1.8.1	$T_{\text{amb}} = 105 \text{ }^\circ\text{C}$; U_R and I_R applied; 2000 h	$U_R \leq 6.3 \text{ V } \Delta C/C: +45 \% / -50 \%$ $U_R \geq 10 \text{ V } \Delta C/C: \pm 45 \%$ $\tan \delta \leq 3 \times \text{spec. limit}$ $Z \leq 3 \times \text{spec. limit}$ $I_{L5} \leq \text{spec. limit}$ no short or open circuit total failure percentage: $\leq 1 \%$
Shelf life (storage at high temperature)	IEC 60384-18 / CECC 32300, subclause 4.17	$T_{\text{amb}} = 105 \text{ }^\circ\text{C}$; no voltage applied; 500 h after test: U_R to be applied for 30 min, 24 h to 48 h before measurement	For requirements see "Endurance test" above

Statements about product lifetime are based on calculations and internal testing. They should only be interpreted as estimations. Also due to external factors, the lifetime in the field application may deviate from the calculated lifetime. In general, nothing stated herein shall be construed as a guarantee of durability.



Disclaimer

ALL PRODUCT, PRODUCT SPECIFICATIONS AND DATA ARE SUBJECT TO CHANGE WITHOUT NOTICE TO IMPROVE RELIABILITY, FUNCTION OR DESIGN OR OTHERWISE.

Vishay Intertechnology, Inc., its affiliates, agents, and employees, and all persons acting on its or their behalf (collectively, "Vishay"), disclaim any and all liability for any errors, inaccuracies or incompleteness contained in any datasheet or in any other disclosure relating to any product.

Vishay makes no warranty, representation or guarantee regarding the suitability of the products for any particular purpose or the continuing production of any product. To the maximum extent permitted by applicable law, Vishay disclaims (i) any and all liability arising out of the application or use of any product, (ii) any and all liability, including without limitation special, consequential or incidental damages, and (iii) any and all implied warranties, including warranties of fitness for particular purpose, non-infringement and merchantability.

Statements regarding the suitability of products for certain types of applications are based on Vishay's knowledge of typical requirements that are often placed on Vishay products in generic applications. Such statements are not binding statements about the suitability of products for a particular application. It is the customer's responsibility to validate that a particular product with the properties described in the product specification is suitable for use in a particular application. Parameters provided in datasheets and / or specifications may vary in different applications and performance may vary over time. All operating parameters, including typical parameters, must be validated for each customer application by the customer's technical experts. Product specifications do not expand or otherwise modify Vishay's terms and conditions of purchase, including but not limited to the warranty expressed therein.

Except as expressly indicated in writing, Vishay products are not designed for use in medical, life-saving, or life-sustaining applications or for any other application in which the failure of the Vishay product could result in personal injury or death. Customers using or selling Vishay products not expressly indicated for use in such applications do so at their own risk. Please contact authorized Vishay personnel to obtain written terms and conditions regarding products designed for such applications.

No license, express or implied, by estoppel or otherwise, to any intellectual property rights is granted by this document or by any conduct of Vishay. Product names and markings noted herein may be trademarks of their respective owners.