

FCA-212 Series, 12 Amperes, DPDT



The Series FCA-212 relay is a polarized single-side stable design, where the flux from a permanent magnet provides the armature holding force in the deactivated state, and its flux path is switched and combined with the coil flux in the operated state. This

results in appreciably increased contact pressure in both states over that of a spring return nonpolar design. We also manufacture other versions of this relay:

FCA-412 — 12 Amp 4PDT Relay

General Specifications

- Temperature Rating** — -70°C TO + 125°C
- Altitude** — 300,000 Feet
- Shock*** — Z, Y, & X Enclosures — 200 g for 6 mS
W & M Enclosures (Stud Mtg.) — 100 g for 6 mS
- Vibration, Sinusoidal*** — Z, Y, & X Enclosures — 30 g 33-3000Hz
W Enclosure — 20 g 33-3000Hz
- Vibration, Random*** — Z, Y, & X Enclosures — 0.4 g²/Hz 50-2000Hz
W & M Enclosures (Stud Mtg.) — 0.2 g²/Hz 50-2000Hz
- Dielectric Strength** — At Sea Level — All circuits to ground and circuit to circuit — 1250 V rms
Coil to ground — 1000 V rms
At 80,000 Feet — 350 V rms
- Insulation Resistance** — Initial (500 VDC) — 100 MΩ Min.
After Life or Environmental Tests — 50 MΩ Min.
- Operate Time at Nominal Voltage** — DC Relays — 10 ms or less
AC Relays — 15 ms or less
- Release Time at Nominal Voltage** — DC Relays — 10 ms or less
AC Relays — 50 ms or less

Product Facts

- Hermetically Sealed
- All Welded Construction
- Balanced Force
- Permanent Magnet Drive
- Contacts — Silver Cadmium Oxide with Gold Plating
- Coils for DC, 50 to 400Hz and 400Hz AC
- Weight 1.6 ounces max. (45.4 grams)

Contact Rating — Amperes Ratings Are Continuous Duty

Type of Load	Life (Min.) Cycles x 10 ³	28 VDC	115VAC 400Hz	115/200VAC 3Ø	
				400Hz	60Hz*
Resistive	100	12	12	12	2.5
Inductive	20	8	8	8	2.5
Motor	100	4	4	4	2.0
Lamp	100	2	2	2	1

*60 Hz loads rated for 10,000 operations

- Overload Current** — 40 AMPS DC, 60 AMPS 400Hz
- Rupture Current** — 50 AMPS DC, 80 AMPS 400Hz
- Contact Make Bounce** — 1 MILLISECOND AT NOMINAL VOLTAGE
- Max. Contact Drop at 12 Amps** — INITIAL 0.150 VOLTS
- End of Life** — 0.175 VOLTS

* Max. contact opening under vibration or shock 10 microseconds

Coil Data

Coil Code	Nominal Voltages	Freq. Hz	DC Res. AC Amps (B)	Over Temperature Range		
				Pickup or Below Volts	Dropout or Above Volts	Must Hold Voltage (C)
1	6	DC	20 Ω	4.5	0.3	2.5
2	12	DC	80 Ω	9.0	0.75	4.5
3	28	DC	320 Ω	18.0	1.5	7.0
4 (A)	28	DC	320 Ω	18.0	1.5	7.0
5	48	DC	920 Ω	32.0	2.5	14.0
6	28	400Hz	180 mA	22.0	1.25	10.0
7	28	50/400Hz	100 mA	22.0	1.25	10.0
8	115	400 Hz	40 mA	90.0	5.0	40.0
9	115	50/400 Hz	30 mA	95.0	5.0	40.0

- A. CODE 4 COILS HAVE BACK EMF SUPPRESSION TO 42 VOLTS MAX.
- B. DC COIL RESISTANCE ± 10% AT 25°C; AC COIL MAX. CURRENT AT NOMINAL VOLTAGE.
- C. RELAY WILL STAY IN PICKED-UP STATE DOWN TO MUST HOLD VOLTAGES SHOWN.
- D. MAX. OVERVOLTAGE: 6 & 12 VDC COILS 120% OF NOMINAL; ALL OTHERS 110% OF NOMINAL.
- E. COILS AVAILABLE FOR OTHER VOLTAGES AND FOR AC 50/60HZ.

FCA-212 Series, 12 Amperes, DPDT (Continued)

Below are shown the standard terminal types and the enclosures available. Specify the assembly as indicated under How To Order. Dimensions are shown in inches ± .010 and (Millimeters ± .25).

Terminals

SOCKET PINS ARE GOLD PLATED
POLARIZING PINS ARE TIN/LEAD PLATED
CIRCUIT BOARD PINS ARE TIN/LEAD PLATED
DIMENSIONS EXCEPT AS NOTED:
INCHES ± .010 (MILLIMETERS ± .25)

CODE "A" Socket Pins - All DC Coils

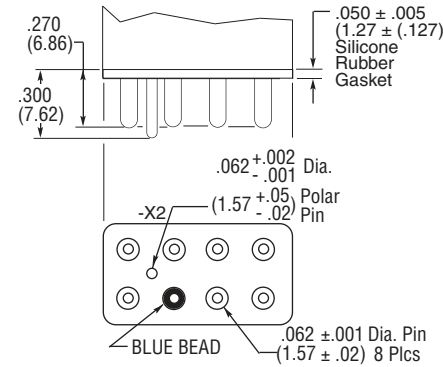

CODE "B" Circuit Board Pins - All DC Coils

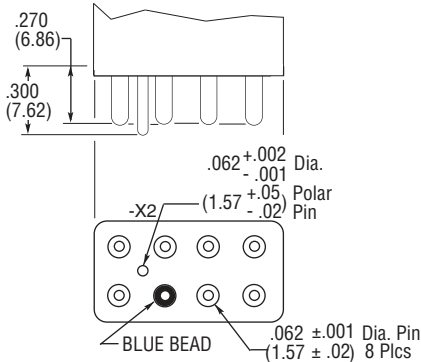

CODE "C" Solder Hook Terminals

HOOK TERMINALS TIN/LEAD PLATED

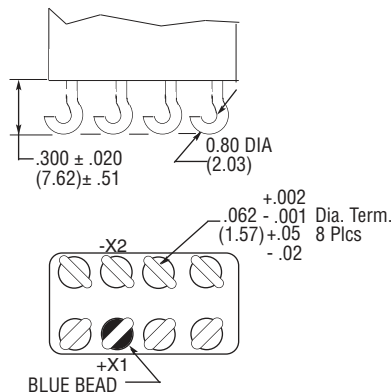

CODE "D" Socket Pins 115 VAC

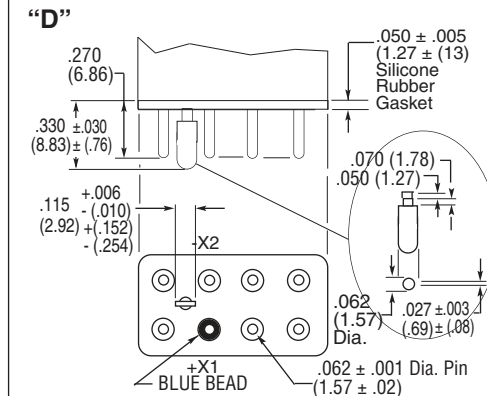

CODE "E" Socket Pins 28 VAC Coils

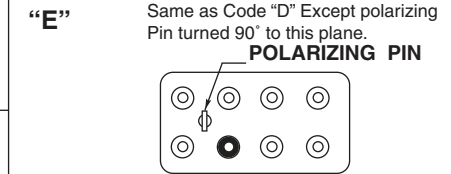

CODE "F" Circuit Board Pins 115 VAC Coils

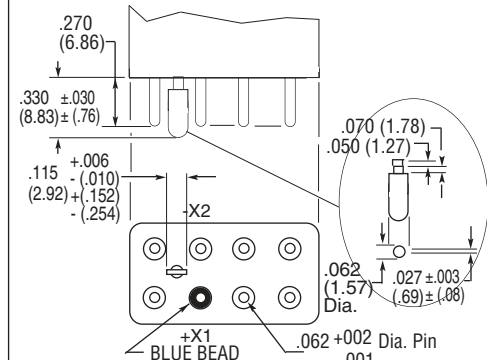

CODE "G" Circuit Board Pins 28 VAC Coils

Same as Code "F" Except polarizing Pin turned 90° to this plane.

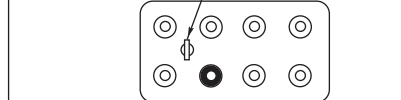

CODE "H" 90° Solder Pins

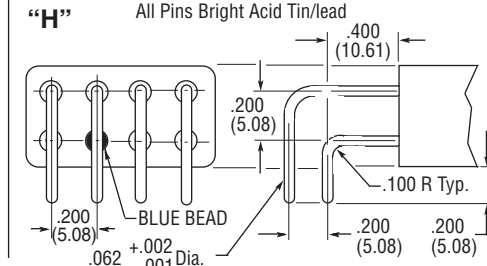

Enclosures

All Enclosures have Cupro-Nickel Cans bright acid tin/lead plated after assembly to terminal headers.

Dimensions: Inches ± .010 (mm ± .25)

"A" AC Coils 1.125 in. (28.57) Max.
DC Coils 1.010 in. (25.65) Max.

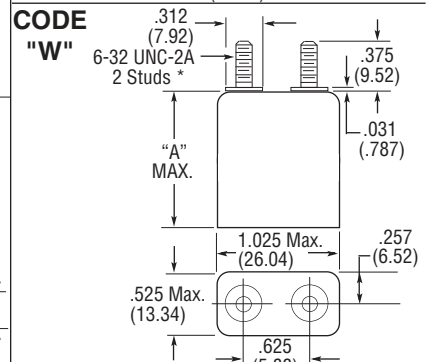
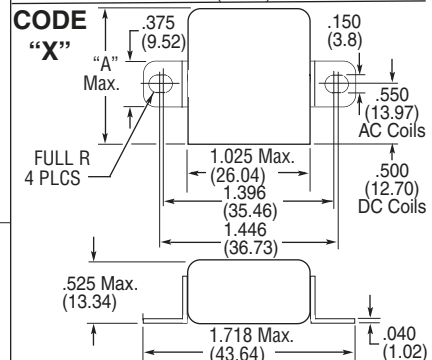
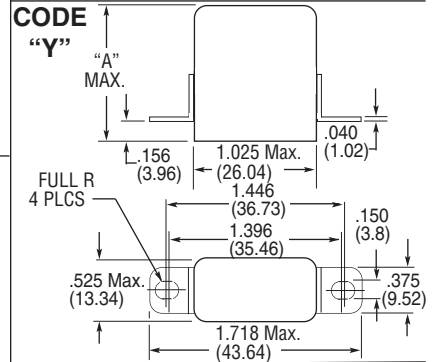
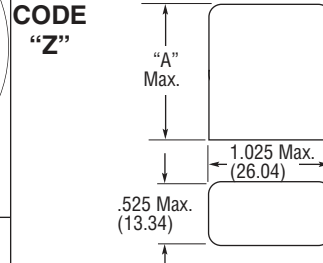

*Metric threads available. To specify use [M] in place of [W]

FCA-212 Series, 12 Amperes, DPDT (Continued)

Terminal Wiring

DC Coils with Transient Suppression

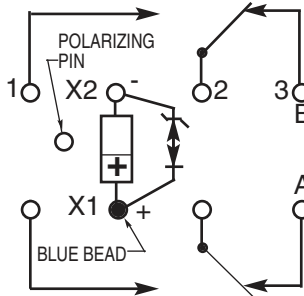

DC Coils

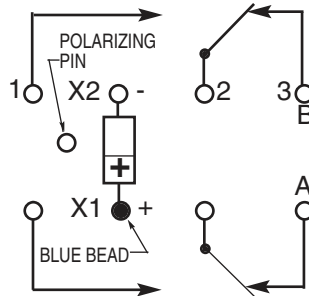

AC Coils 115 VAC

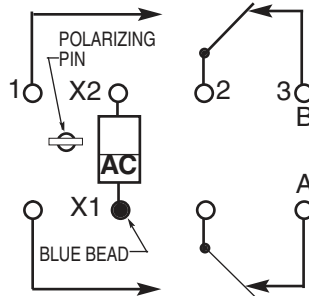

AC Coils 28 VAC

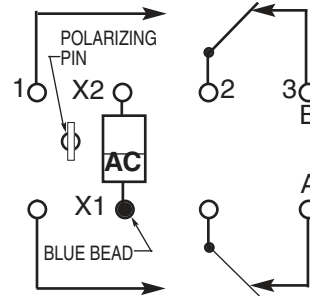

NOTE: Polarity must be observed with DC coil supply. Relay is polarized with a permanent magnet and will not operate or be damaged by reverse polarity.

Diodes used in transient suppression and in AC rectifier circuits have peak inverse voltage rating of 600 VDC minimum. Zener diodes have a minimum rating of 1 watt.

Terminal designations are for reference only and do not appear on the header.

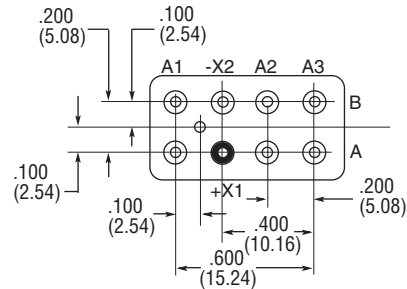

TERMINAL VIEW

HOW TO ORDER

FCA-212-A Y 4

RELAY TYPE _____

TERMINALS (Socket Pins, DC Coil) _____

ENCLOSURE (With Flanges) _____

COIL (28 VDC With Transient Suppression). _____