

DO NOT SCALE FROM THIS PRINT

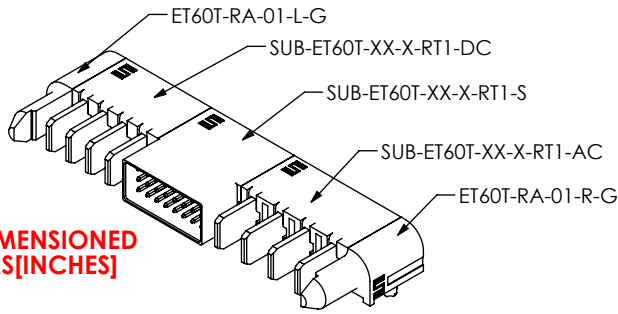

DESIGNED & DIMENSIONED IN MILLIMETERS [INCHES]

POWER OPTION (LEFT)

- AXX: AC POWER
- DXX: DC POWER
- \*-SXX: SPLIT POWER
- 000: NO POWER (SEE NOTE 5)

ROWS

- 0: NO SIGNAL
- 3: 3 ROWS
- 5: 5 ROWS

SIGNAL POS PER ROW

- 00: NO SIGNAL
- XX: SEE NOTE 6

POWER OPTION (RIGHT)

- AXX: AC POWER
- DXX: DC POWER
- \*-SXX: SPLIT POWER
- 000: NO POWER (SEE NOTE 5)

OPTIONS

- H: HOT SWAP (NOT AVAILABLE WITH -SXX) (LEAVE BLANK FOR NO HOT SWAP) (AVAILABLE FOR 3 SIGNAL ROW AND POWER OPTION ONLY)
- GUIDE POST (MUST CHOOSE ONE)
- \*\* -T: TOP
- S: SIDE
- TAIL
- R1: FOR .062" PCB
- R2: FOR .093" PCB (NOT AVAILABLE FOR -3 SIGNAL ROW)
- RP: PRESS FIT (NOT AVAILABLE FOR -3 SIGNAL ROW)

PLATING SPECIFICATION

- L: 10 μ" SELECTIVE GOLD IN CONTACT AREA, MATTE TIN ON TAIL
- S: 30 μ" SELECTIVE GOLD IN CONTACT AREA, MATTE TIN ON TAIL
- (\* = NOT TOOLED)
- (\*\* = NOT RELEASED)

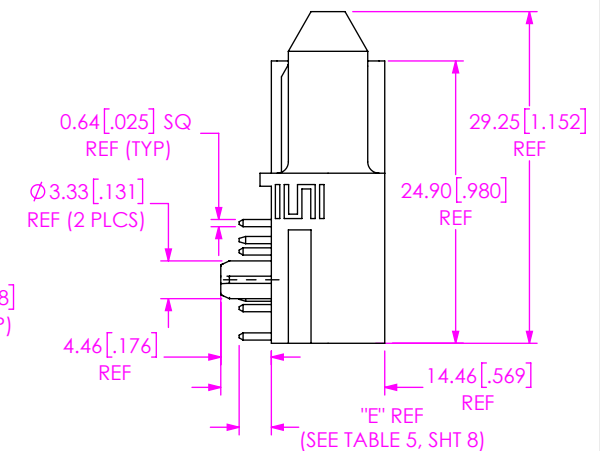
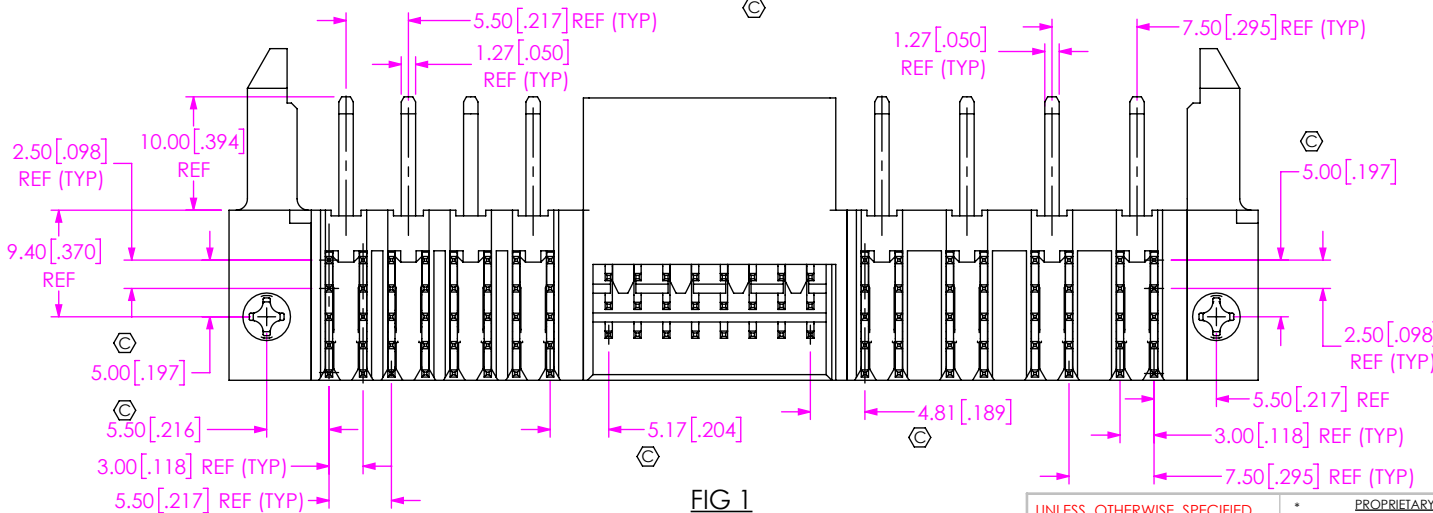
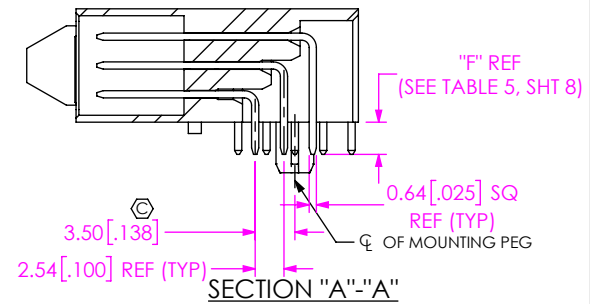
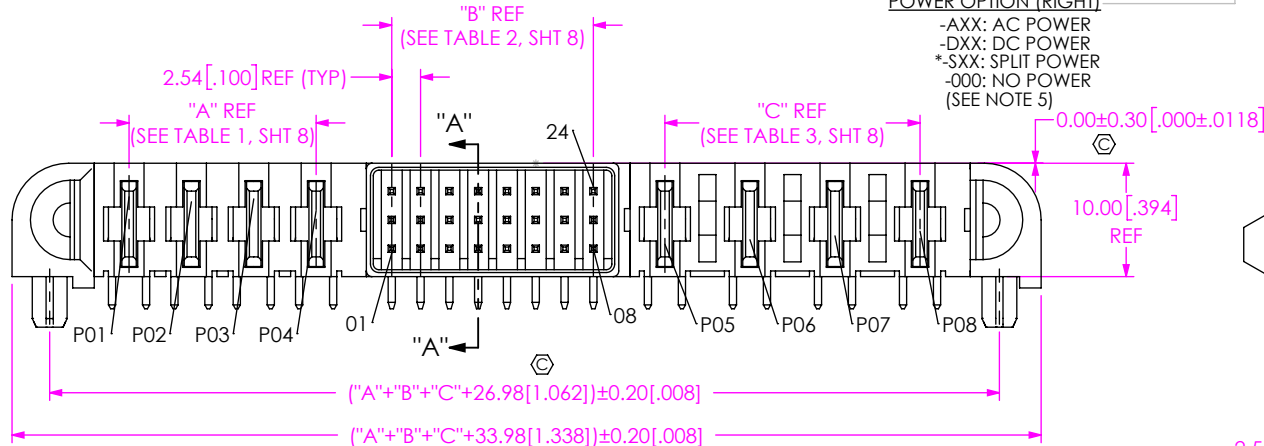

FIG 1  
ET60T-D04-3-08-A04-X-R1-S SHOWN

- NOTES:
1. Ⓢ REPRESENTS A CRITICAL DIMENSION.
  2. MINIMUM PUSHOUT FORCE: 3.0 LBS FOR SIGNAL & POWER PINS.
  3. SEE PRODUCT SPECIFICATION FOR CONNECTOR PRESS FIT INSTRUCTIONS AND REQUIRED FIXTURES.
  4. ASSEMBLIES TO BE PACKAGED IN TRAYS.
  5. -AC POWER: \*-01, -02, -03, -04, -05, -06;
  - DC POWER: \*-01, -02, -03, -04, -05, -06, -07, -08, -09, -10.
  6. -3 ROWS: \*-02, \*-04, \*-06, -08, \*-10, \*-12;
  - 5 ROWS: -01, -02, -03, -04, -05, -06, -07, -08
  7. ORDERS WILL BE PACKAGED ACCORDING TO THE SAMTEC PACKAGING EFFICIENCY STANDARDS (SPES) FOUND ON WWW.SAMTEC.COM.

UNLESS OTHERWISE SPECIFIED, DIMENSIONS ARE IN MILLIMETERS.

TOLERANCES ARE:

DECIMALS	ANGLES
X.X: ±0.3 [01]	2°
X.XX: ±0.13 [005]	
X.XXX: ±0.051 [0020]	

MATERIAL: DO NOT SCALE DRAWING SHEET SCALE: 3:2

INSULATOR: LCP, COLOR: BLACK  
SIGNAL TERMINAL: COPPER ALLOY  
POWER TERMINAL: COPPER ALLOY

F:\DWG\MISC\MKTG\ET60T-XXX-X-XX-XXX-X-RX-X-X-MKT.SLDDRW

PROPRIETARY NOTE

THIS DOCUMENT CONTAINS CONFIDENTIAL AND PROPRIETARY INFORMATION AND ALL DESIGN, MANUFACTURING, REPRODUCTION, USE, PATENT RIGHTS AND SALES RIGHTS ARE EXPRESSLY RESERVED BY SAMTEC, INC. THIS DOCUMENT SHALL NOT BE DISCLOSED, IN WHOLE OR PART, TO ANY UNAUTHORIZED PERSON OR ENTITY NOR REPRODUCED, TRANSFERRED OR INCORPORATED IN ANY OTHER PROJECT IN ANY MANNER WITHOUT THE EXPRESS WRITTEN CONSENT OF SAMTEC, INC.



520 PARK EAST BLVD., NEW ALBANY, IN 47150  
PHONE: 812-944-6733 FAX: 812-948-5047  
e-Mail: info@SAMTEC.com code 53322

DESCRIPTION: ET60 RA POWER/SIGNAL HEADER

DWG. NO. ET60T-XXX-X-XX-XXX-X-RX-X-X

BY: JOE Z 07/29/2016 SHEET 1 OF 10

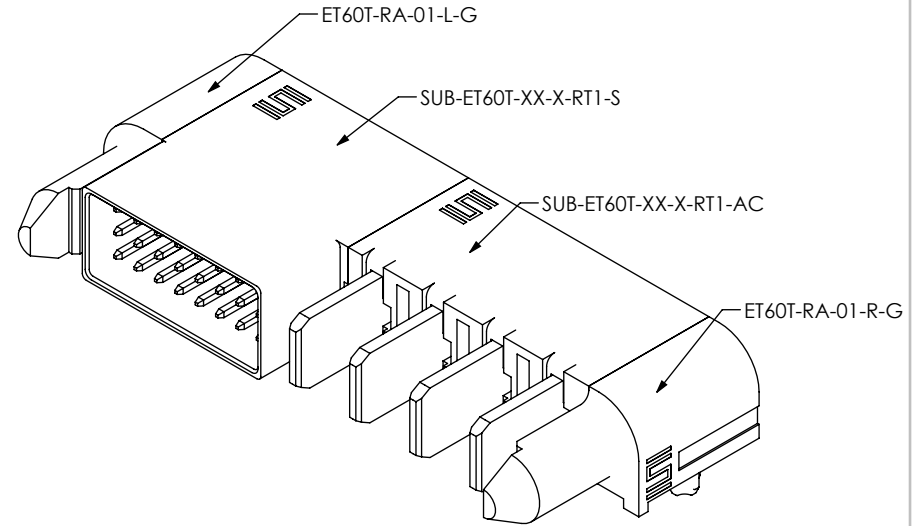
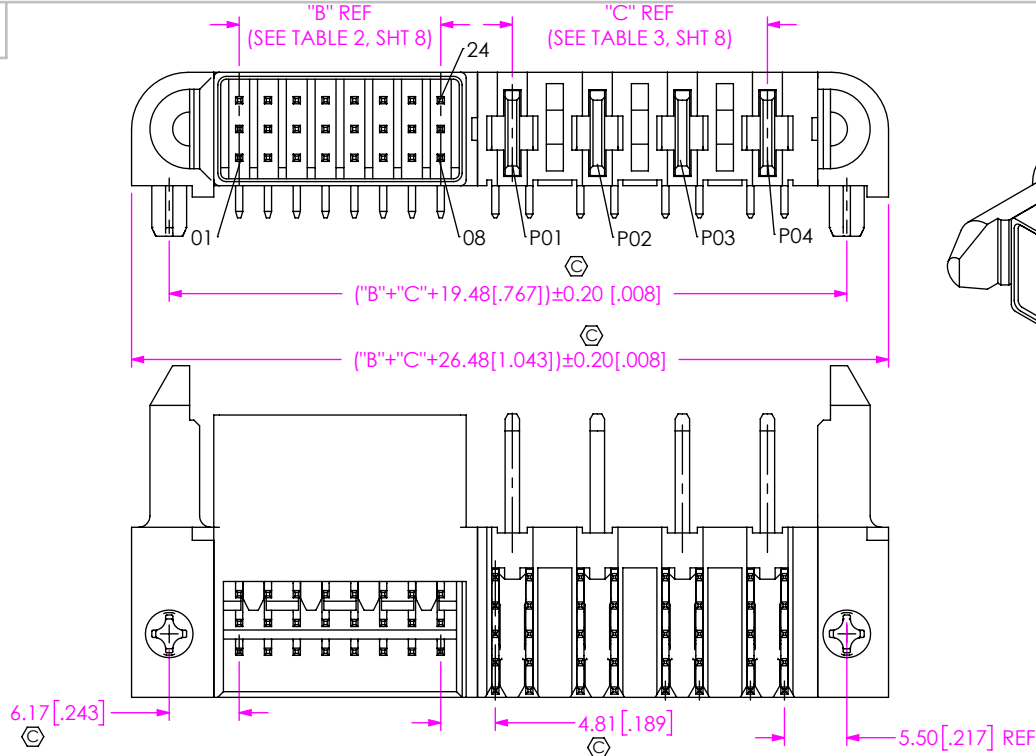

FIG 2  
ET60T-000-3-08-A04-X-R1-S SHOWN  
(DIFFERENT AS SHOWN, OTHERWISE SAME AS FIG 1)

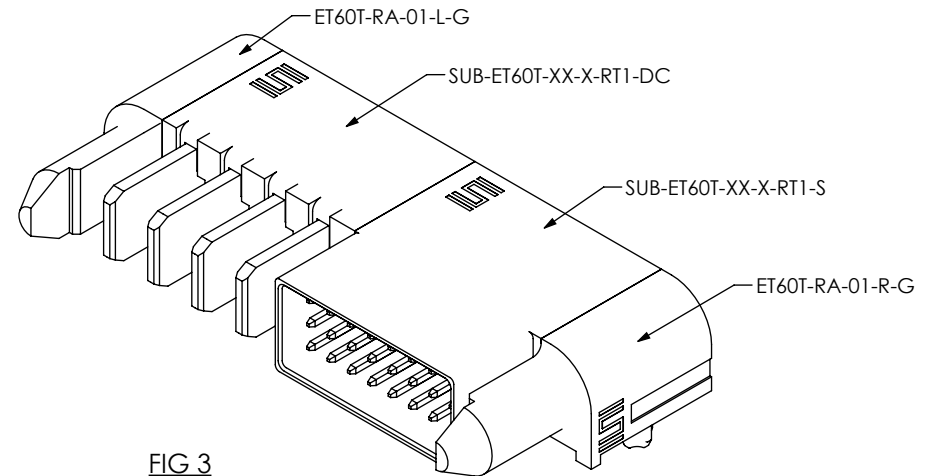
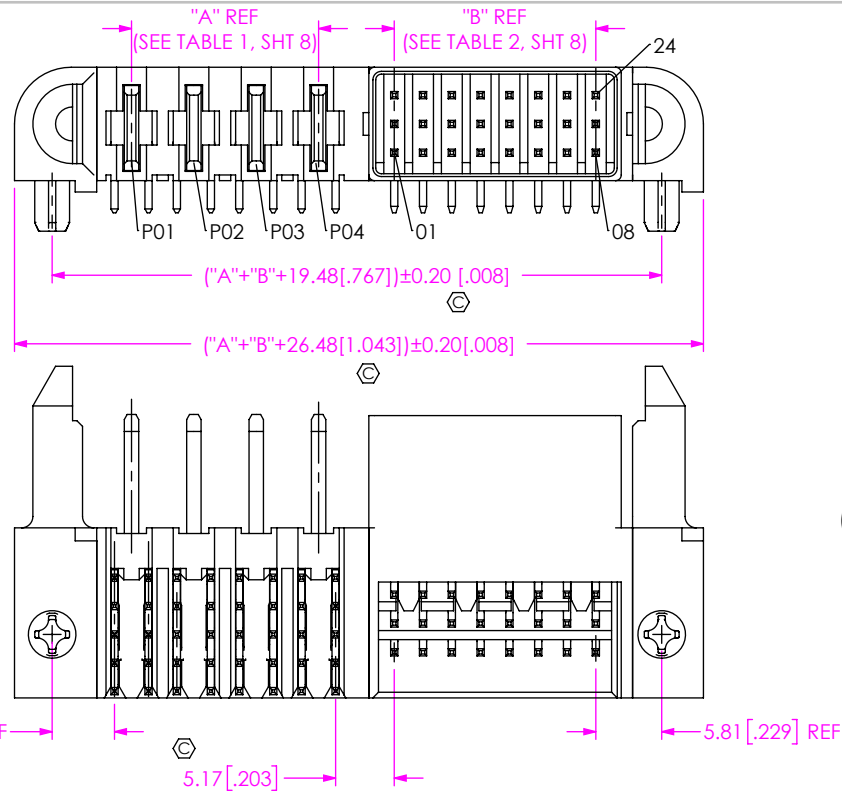

FIG 3  
ET60T-D04-3-08-000-X-R1-S SHOWN  
(DIFFERENT AS SHOWN, OTHERWISE SAME AS FIG 1)

PROPRIETARY NOTE  
THIS DOCUMENT CONTAINS CONFIDENTIAL AND PROPRIETARY INFORMATION AND ALL DESIGN, MANUFACTURING, REPRODUCTION, USE, PATENT RIGHTS AND SALES RIGHTS ARE EXPRESSLY RESERVED BY SAMTEC, INC. THIS DOCUMENT SHALL NOT BE DISCLOSED, IN WHOLE OR PART, TO ANY UNAUTHORIZED PERSON OR ENTITY NOR REPRODUCED, TRANSFERRED OR INCORPORATED IN ANY OTHER PROJECT IN ANY MANNER WITHOUT THE EXPRESS WRITTEN CONSENT OF SAMTEC, INC.

SHEET SCALE: 3:2

**samtec**

520 PARK EAST BLVD, NEW ALBANY, IN 47150  
PHONE: 812-944-6733 FAX: 812-948-5047  
e-Mail: info@SAMTEC.com code 55322

DESCRIPTION:  
ET60 RA POWER/SIGNAL HEADER

DWG. NO.  
ET60T-XXX-X-XX-XXX-X-RX-X-X

BY: JOE Z 07/29/2016 SHEET 2 OF 10

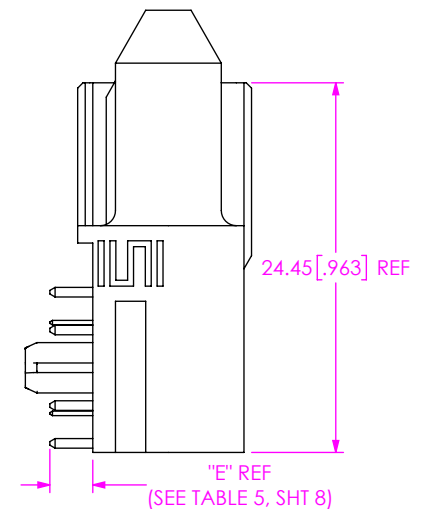
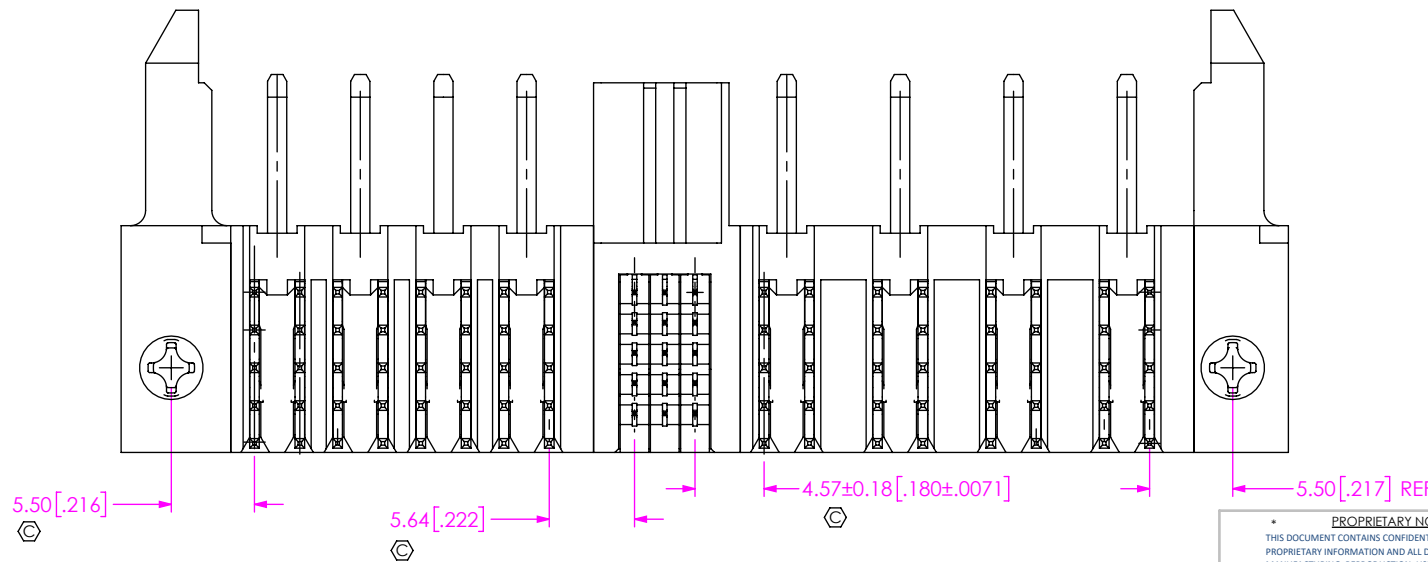
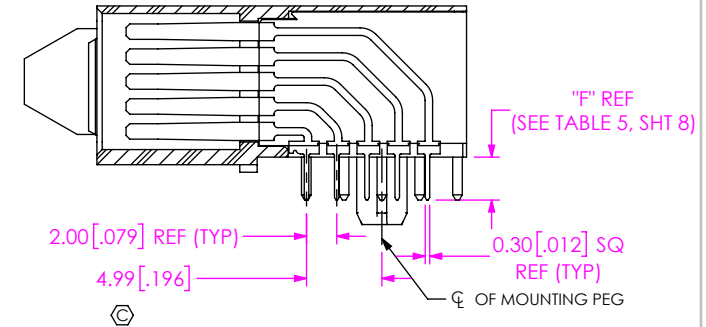
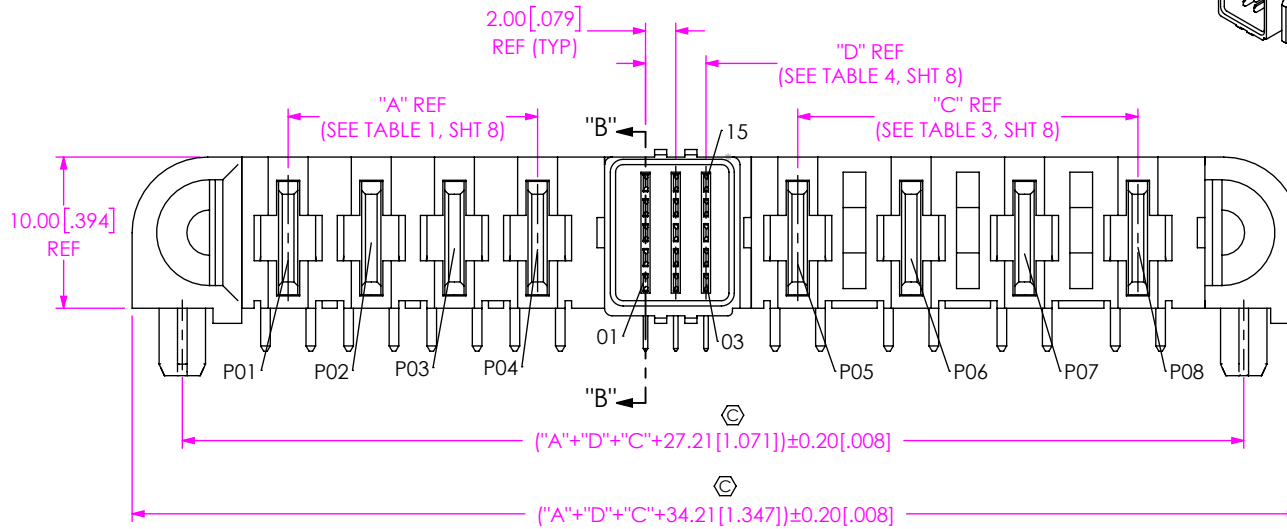
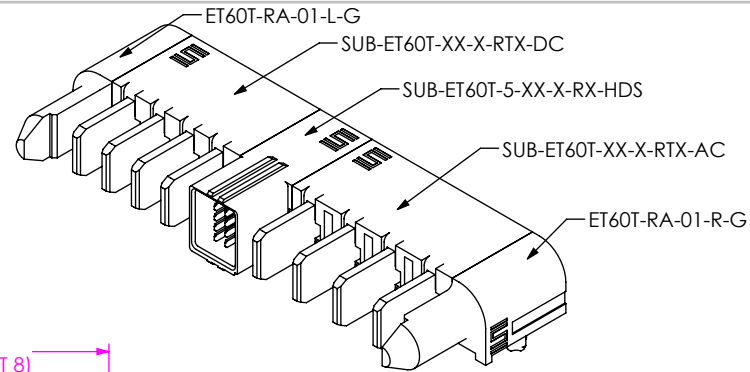

FIG 4  
ET60T-D04-5-03-A04-X-RX-S SHOWN  
(DIFFERENT AS SHOWN, OTHERWISE SAME AS FIG 1)

**PROPRIETARY NOTE**  
THIS DOCUMENT CONTAINS CONFIDENTIAL AND PROPRIETARY INFORMATION AND ALL DESIGN, MANUFACTURING, REPRODUCTION, USE, PATENT RIGHTS AND SALES RIGHTS ARE EXPRESSLY RESERVED BY SAMTEC, INC. THIS DOCUMENT SHALL NOT BE DISCLOSED, IN WHOLE OR PART, TO ANY UNAUTHORIZED PERSON OR ENTITY NOR REPRODUCED, TRANSFERRED OR INCORPORATED IN ANY OTHER PROJECT IN ANY MANNER WITHOUT THE EXPRESS WRITTEN CONSENT OF SAMTEC, INC.



520 PARK EAST BLVD. NEW ALBANY, IN 47150  
PHONE: 812-944-6733 FAX: 812-948-5047  
e-Mail: info@SAMTEC.com code 55322

SHEET SCALE: 3:2

DESCRIPTION:  
ET60 RA POWER/SIGNAL HEADER

DWG. NO.  
ET60T-XXX-X-XX-XXX-X-RX-X-X

BY: JOE Z 07/29/2016 SHEET 3 OF 10

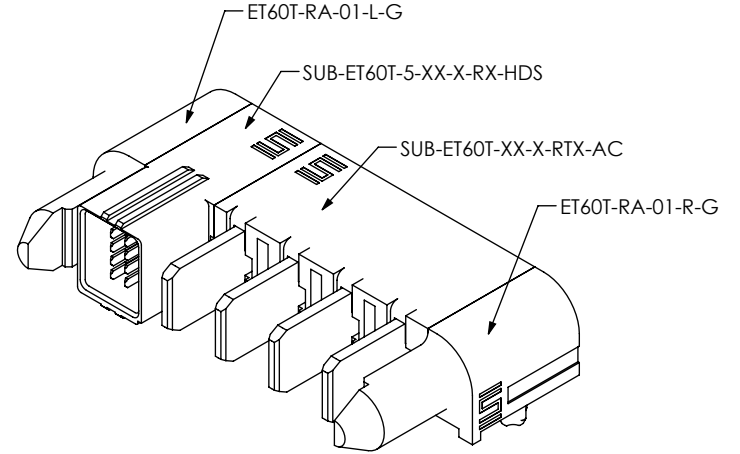
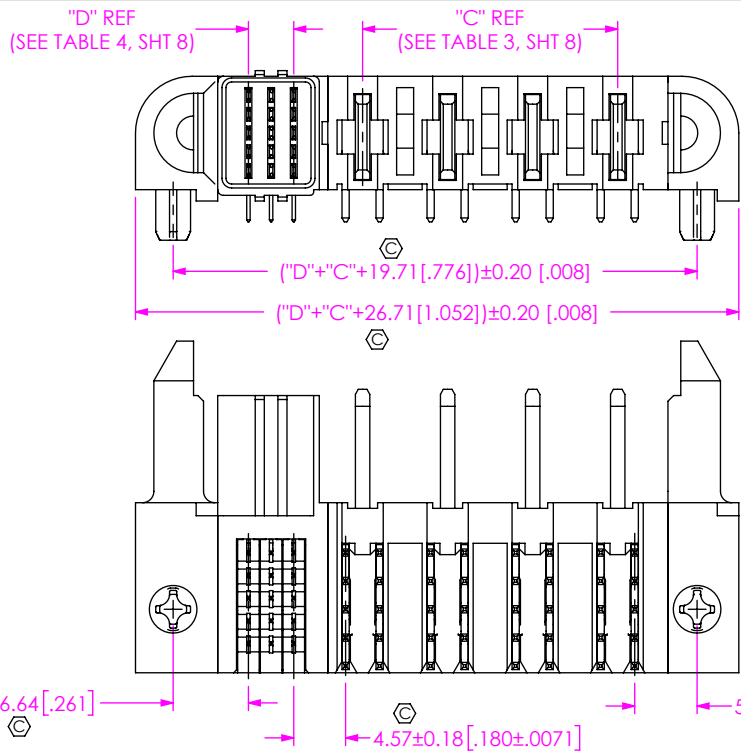

FIG 5  
ET60T-000-5-03-A04-X-RX-S SHOWN  
(DIFFERENT AS SHOWN, OTHERWISE SAME AS FIG 4)

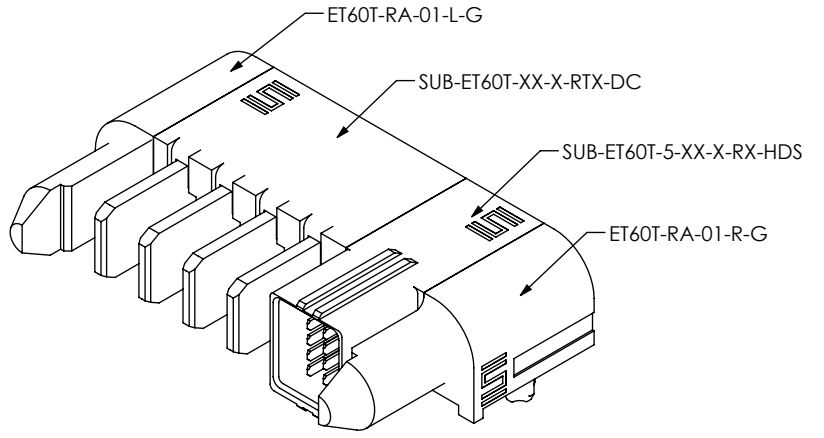
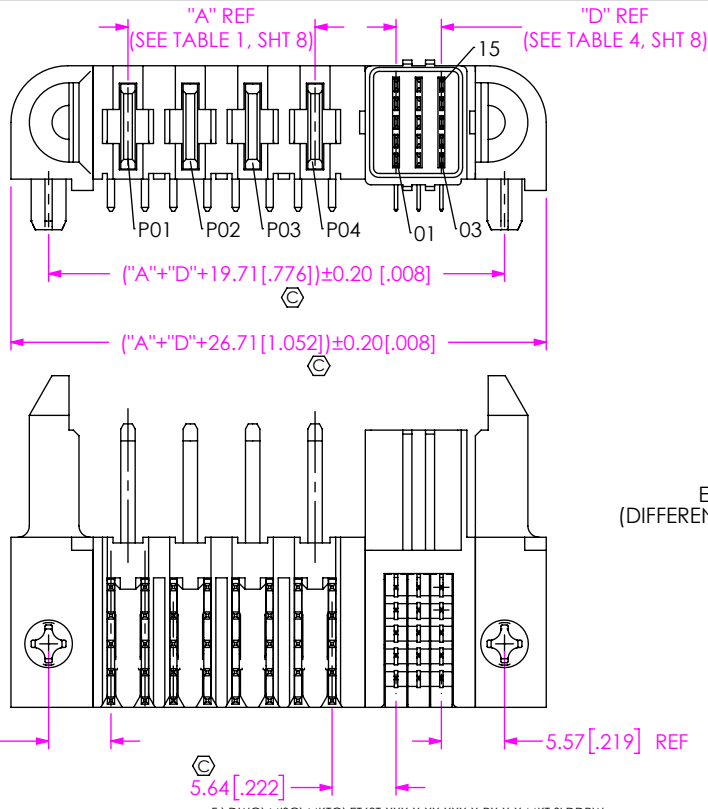

FIG 6  
ET60T-D04-5-03-000-X-RX-S SHOWN  
(DIFFERENT AS SHOWN, OTHERWISE SAME AS FIG 4)

**PROPRIETARY NOTE**  
THIS DOCUMENT CONTAINS CONFIDENTIAL AND PROPRIETARY INFORMATION AND ALL DESIGN, MANUFACTURING, REPRODUCTION, USE, PATENT RIGHTS AND SALES RIGHTS ARE EXPRESSLY RESERVED BY SAMTEC, INC. THIS DOCUMENT SHALL NOT BE DISCLOSED, IN WHOLE OR PART, TO ANY UNAUTHORIZED PERSON OR ENTITY NOR REPRODUCED, TRANSFERRED OR INCORPORATED IN ANY OTHER PROJECT IN ANY MANNER WITHOUT THE EXPRESS WRITTEN CONSENT OF SAMTEC, INC.



520 PARK EAST BLVD, NEW ALBANY, IN 47150  
PHONE: 812-944-6733 FAX: 812-948-5047  
e-Mail info@SAMTEC.com code 53322

SHEET SCALE: 3:2

DESCRIPTION:  
ET60 RA POWER/SIGNAL HEADER

DWG. NO.  
ET60T-XXX-X-XX-XXX-X-RX-X-X

BY: JOE Z 07/29/2016 SHEET 4 OF 10

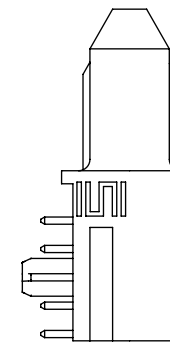
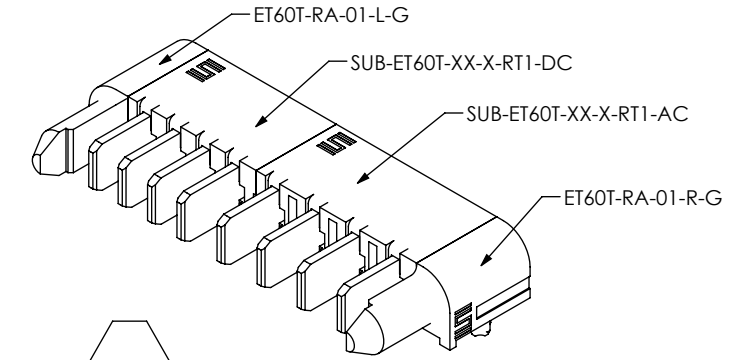
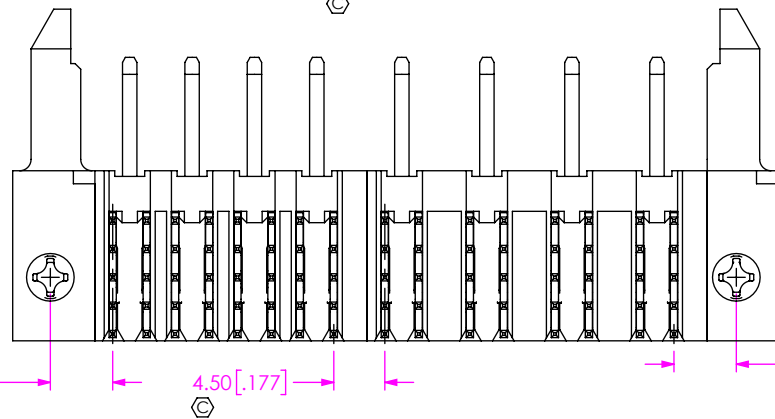
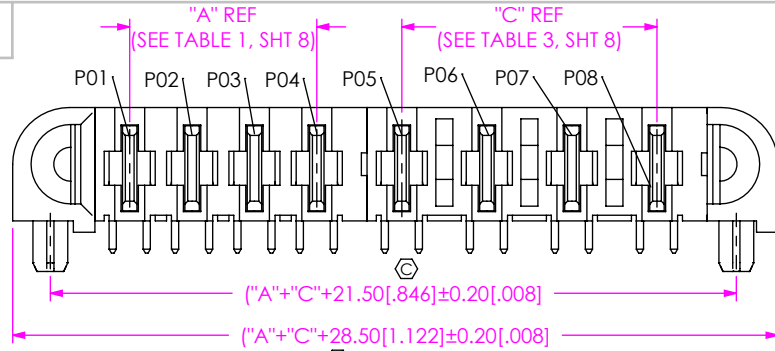

FIG 7  
 ET60T-D04-0-00-A04-X-R1-S SHOWN  
 (DIFFERENT AS SHOWN, OTHERWISE SAME AS FIG 1)

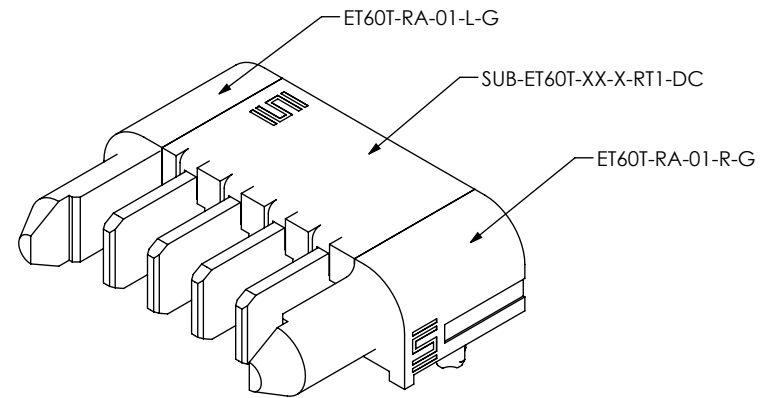
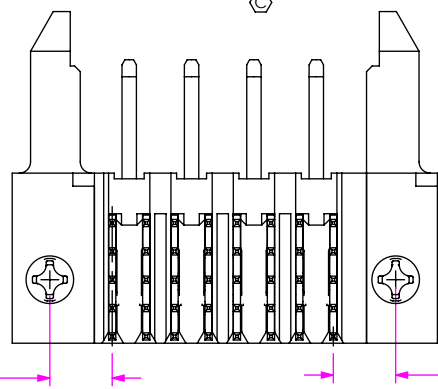
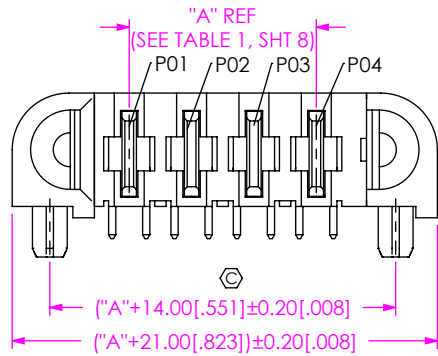

FIG 8  
 ET60T-D04-0-00-000-X-R1-S SHOWN  
 (DIFFERENT AS SHOWN, OTHERWISE SAME AS FIG 1)

**PROPRIETARY NOTE**  
 THIS DOCUMENT CONTAINS CONFIDENTIAL AND PROPRIETARY INFORMATION AND ALL DESIGN, MANUFACTURING, REPRODUCTION, USE, PATENT RIGHTS AND SALES RIGHTS ARE EXPRESSLY RESERVED BY SAMTEC, INC. THIS DOCUMENT SHALL NOT BE DISCLOSED, IN WHOLE OR PART, TO ANY UNAUTHORIZED PERSON OR ENTITY NOR REPRODUCED, TRANSFERRED OR INCORPORATED IN ANY OTHER PROJECT IN ANY MANNER WITHOUT THE EXPRESS WRITTEN CONSENT OF SAMTEC, INC.



520 PARK EAST BLVD, NEW ALBANY, IN 47150  
 PHONE: 812-944-6733 FAX: 812-948-5047  
 e-Mail info@SAMTEC.com code 55322

SHEET SCALE: 3:2

DESCRIPTION:  
 ET60 RA POWER/SIGNAL HEADER

DWG. NO.  
 ET60T-XXX-X-XX-XXX-X-RX-X-X

BY: JOE Z 07/29/2016 SHEET 5 OF 10





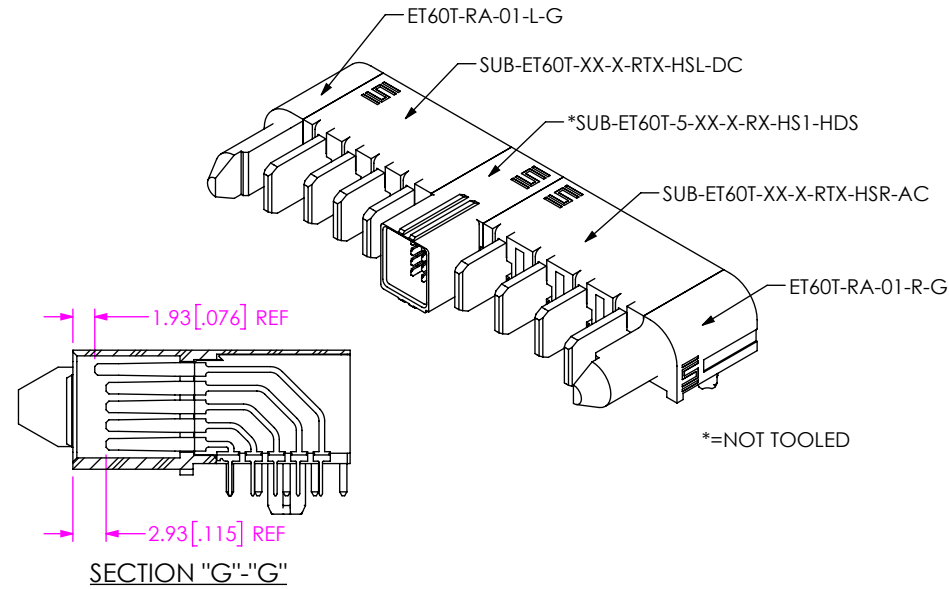
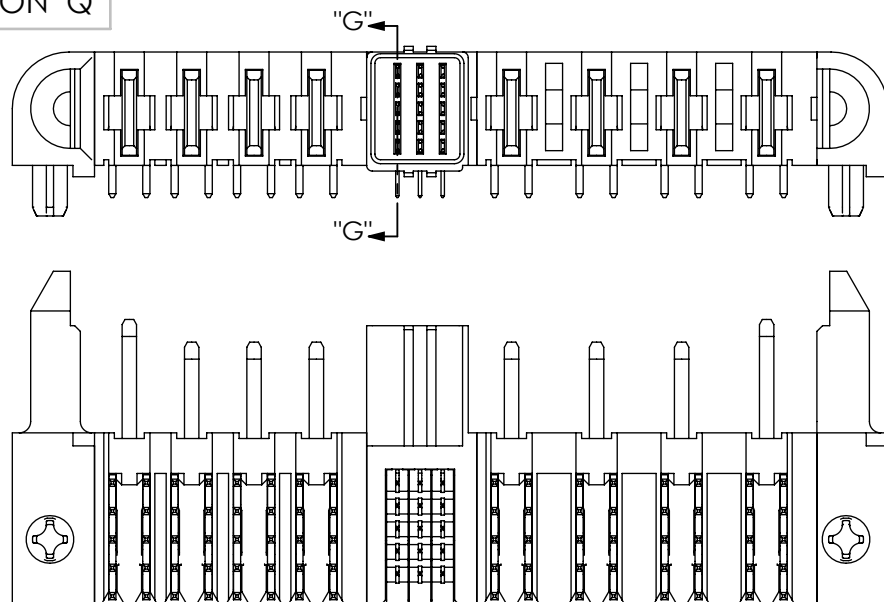

FIG 13  
ET60T-D04-5-03-A04-X-RX-S-H SHOWN  
(DIFFERENT AS SHOWN, OTHERWISE SAME AS FIG 12)

TABLE 1  
(SEE NOTE 5)

POWER POS (LEFT)	"A"	
	DC POWER	AC POWER
-01	N/A	N/A
-02	5.50 [.217]	7.50 [.295]
-03	11.00 [.433]	15.00 [.591]
-04	16.50 [.650]	22.50 [.886]
-05	22.00 [.866]	30.00 [1.181]
-06	27.50 [1.083]	37.50 [1.476]
-07	33.00 [1.299]	/
-08	38.50 [1.516]	/
-09	44.00 [1.732]	/
-10	49.50 [1.949]	/

TABLE 2  
(SEE NOTE 6)

SIGNAL POS (-3 ROWS)	"B"
-02	2.54 [.100]
-04	7.62 [.300]
-06	12.70 [.500]
-08	17.78 [.700]
-10	22.86 [.900]
-12	27.94 [1.100]

TABLE 3  
(SEE NOTE 5)

POWER POS (RIGHT)	"C"	
	DC POWER	AC POWER
-01	N/A	N/A
-02	5.50 [.217]	7.50 [.295]
-03	11.00 [.433]	15.00 [.591]
-04	16.50 [.650]	22.50 [.886]
-05	22.00 [.866]	30.00 [1.181]
-06	27.50 [1.083]	37.50 [1.476]
-07	33.00 [1.299]	/
-08	38.50 [1.516]	/
-09	44.00 [1.732]	/
-10	49.50 [1.949]	/

TABLE 4  
(SEE NOTE 6)

SIGNAL POS (-5 ROWS)	"D"
-01	N/A
-02	2.00 [.079]
-03	4.00 [.157]
-04	6.00 [.236]
-05	8.00 [.315]
-06	10.00 [.394]
-07	12.00 [.472]
-08	14.00 [.551]

TABLE 5

TAIL	"E"	"F"
-R1	2.84 [.112]	2.84 [.112]
-R2	3.61 [.142]	3.41 [.134]
-RP	3.28 [.129]	2.50 [.098]

PROPRIETARY NOTE

THIS DOCUMENT CONTAINS CONFIDENTIAL AND PROPRIETARY INFORMATION AND ALL DESIGN, MANUFACTURING, REPRODUCTION, USE, PATENT RIGHTS AND SALES RIGHTS ARE EXPRESSLY RESERVED BY SAMTEC, INC. THIS DOCUMENT SHALL NOT BE DISCLOSED, IN WHOLE OR PART, TO ANY UNAUTHORIZED PERSON OR ENTITY NOR REPRODUCED, TRANSFERRED OR INCORPORATED IN ANY OTHER PROJECT IN ANY MANNER WITHOUT THE EXPRESS WRITTEN CONSENT OF SAMTEC, INC.



520 PARK EAST BLVD, NEW ALBANY, IN 47150  
PHONE: 812-944-6733 FAX: 812-948-5047  
e-Mail: info@SAMTEC.com code 55322

SHEET SCALE: 3:2

DESCRIPTION:  
ET60 RA POWER/SIGNAL HEADER

DWG. NO.  
ET60T-XXX-X-XX-XXX-X-RX-X-X

BY: JOE Z 07/29/2016 SHEET 8 OF 10



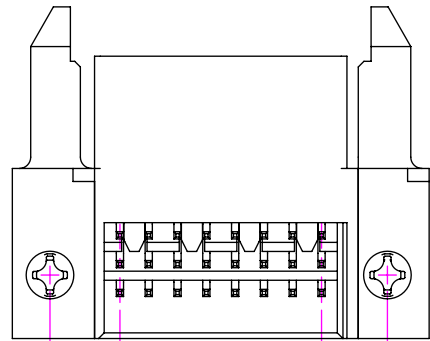
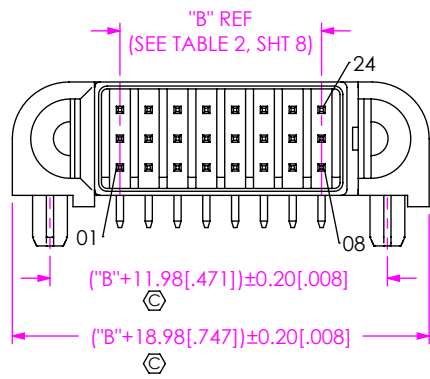

6.17[.243] 5.81[.229] REF

**FIG 14**  
ET60T-000-3-08-000-X-R1-S SHOWN  
(DIFFERENT AS SHOWN, OTHERWISE SAME AS FIG 1)

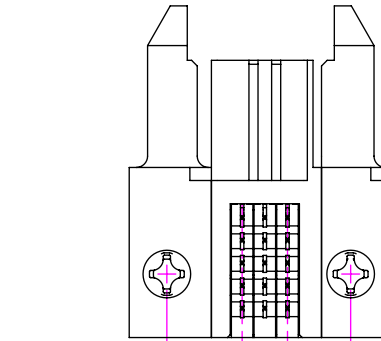
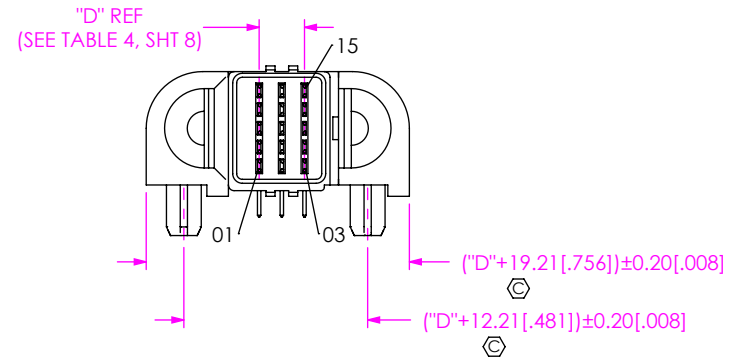

6.64[.261] 5.57[.219] REF

**FIG 15**  
ET60T-000-5-03-000-X-RX-S SHOWN  
(DIFFERENT AS SHOWN, OTHERWISE SAME AS FIG 4)

**PROPRIETARY NOTE**

THIS DOCUMENT CONTAINS CONFIDENTIAL AND PROPRIETARY INFORMATION AND ALL DESIGN, MANUFACTURING, REPRODUCTION, USE, PATENT RIGHTS AND SALES RIGHTS ARE EXPRESSLY RESERVED BY SAMTEC, INC. THIS DOCUMENT SHALL NOT BE DISCLOSED, IN WHOLE OR PART, TO ANY UNAUTHORIZED PERSON OR ENTITY NOR REPRODUCED, TRANSFERRED OR INCORPORATED IN ANY OTHER PROJECT IN ANY MANNER WITHOUT THE EXPRESS WRITTEN CONSENT OF SAMTEC, INC.



520 PARK EAST BLVD, NEW ALBANY, IN 47150  
PHONE: 812-944-6733 FAX: 812-948-5047  
e-Mail info@SAMTEC.com code 55322

SHEET SCALE: 3:2

DESCRIPTION:  
ET60 RA POWER/SIGNAL HEADER

DWG. NO.  
ET60T-XXX-X-XX-XXX-X-RX-X-X

BY: JOE Z 07/29/2016 SHEET 9 OF 10

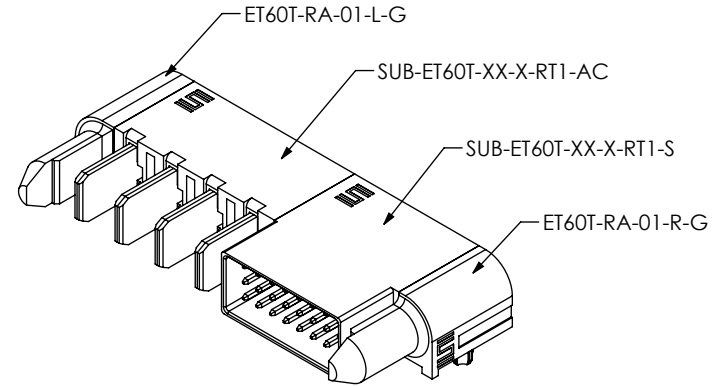
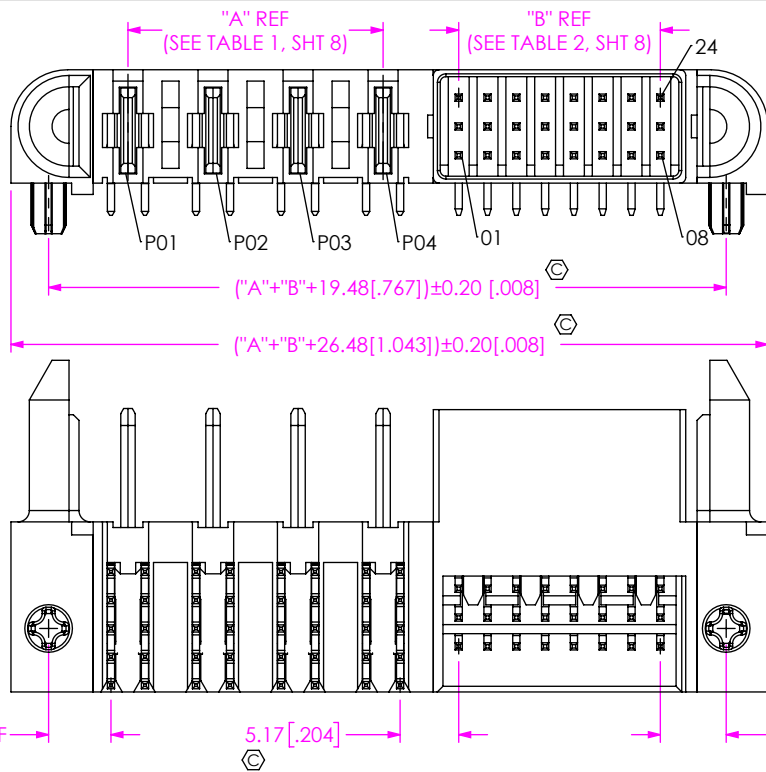

FIG 16  
ET60T-A04-3-08-000-X-R1-S SHOWN  
(DIFFERENT AS SHOWN, OTHERWISE SAME AS FIG 1)

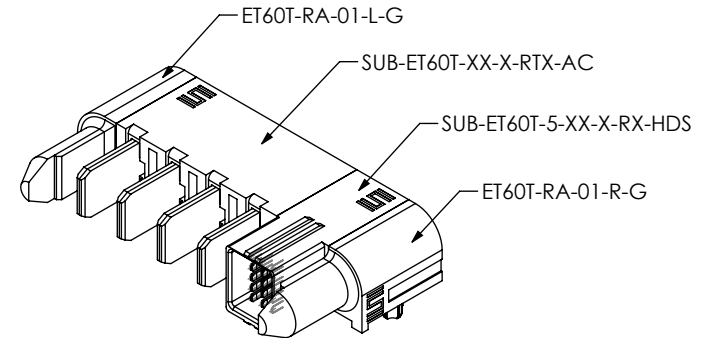
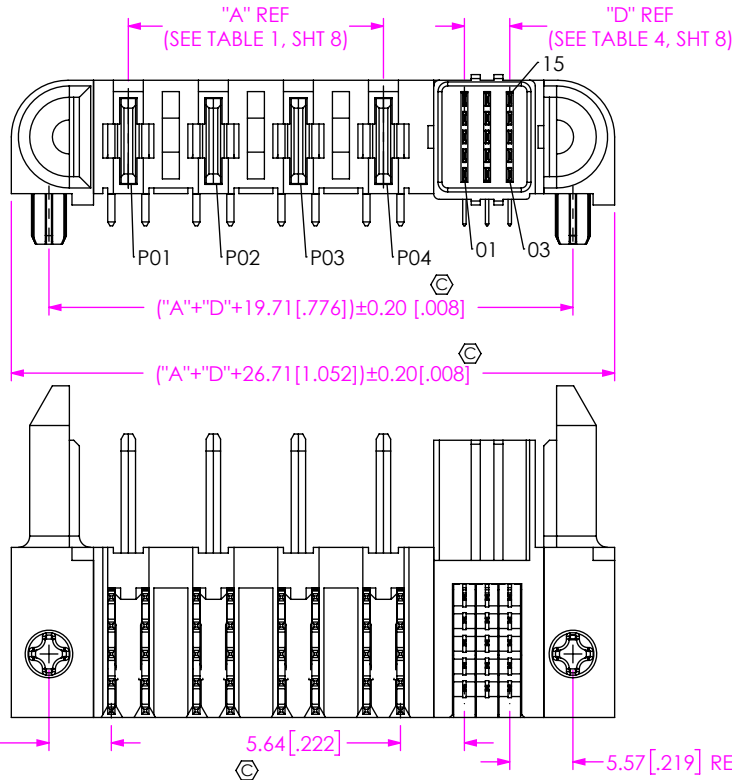

FIG 17  
ET60T-A04-5-03-000-X-RX-S SHOWN  
(DIFFERENT AS SHOWN, OTHERWISE SAME AS FIG 4)

F:\DWG\MISC\MKTG\ET60T-XXX-X-XX-XXX-X-RX-X-X-MKT.SLDDRW

<p><b>PROPRIETARY NOTE</b></p> <p>THIS DOCUMENT CONTAINS CONFIDENTIAL AND PROPRIETARY INFORMATION AND ALL DESIGN, MANUFACTURING, REPRODUCTION, USE, PATENT RIGHTS AND SALES RIGHTS ARE EXPRESSLY RESERVED BY SAMTEC, INC. THIS DOCUMENT SHALL NOT BE DISCLOSED, IN WHOLE OR PART, TO ANY UNAUTHORIZED PERSON OR ENTITY NOR REPRODUCED, TRANSFERRED OR INCORPORATED IN ANY OTHER PROJECT IN ANY MANNER WITHOUT THE EXPRESS WRITTEN CONSENT OF SAMTEC, INC.</p>	 <p>520 PARK EAST BLVD. NEW ALBANY, IN 47150 PHONE: 812-944-6733 FAX: 812-948-5047 e-Mail: info@SAMTEC.com code 55322</p>	
	<p>DESCRIPTION: ET60 RA POWER/SIGNAL HEADER</p>	
	<p>DWG. NO. ET60T-XXX-X-XX-XXX-X-RX-X-X</p>	<p>BY: JOE Z 07/29/2016 SHEET 10 OF 10</p>