

# PC-16

## 16-mm carbon panel mount potentiometer

The PC-16 is a single-turn panel control potentiometer using a carbon resistive element with plastic housing and incorporated shaft. A wide variety of configurable options, such as ganging up to four modules, different shaft types and tapers, make the PC-16 suitable for numerous applications in the home appliance, industrial and automotive markets.

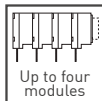
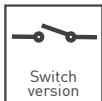

### KEY FEATURES

- ▶ IP54 protection according to IEC 60529
- ▶ Modular gang type (up to 4)
- ▶ Self extinguishable material UL 94-V0
- ▶ Selection of plastic and metal shafts
- ▶ Linear, log (audio) and antilog (reverse) tapers
- ▶ Solder lugs or PC pins

### On request

- ▶ Stereo matching
- ▶ Rotary switch
- ▶ Nut & washer
- ▶ Bushless & shaftless models
- ▶ Assemblies with wires and connectors
- ▶ Metallic support (mounting brackets)

### ELECTRICAL SPECIFICATIONS

Taper	Lin, Log, Alog
Range of values* (Decad. 1.0 - 2.0 - 2.2 - 2.5 - 4.7 - 5.0)	
Lin	100Ω ≤ Rn ≤ 5MΩ
Log, Alog	1KΩ ≤ Rn ≤ 5MΩ
Tolerance*	
100Ω ≤ Rn ≤ 1MΩ	±20%
1MΩ < Rn ≤ 5MΩ	±30%
Max. Voltage	
Lin	250 VDC
Log, Alog	125 VDC
Nominal power 50°C (122°F)	
Lin	0.2 W
Log, Alog	0.1 W
Residual resistance	≤ 5% Rn (5Ω min.)
Equivalent noise resistance	≤ 3% Rn (3Ω min.)
Operating temperature**	-25°C to +70°C (-13°F to + 158°F)

\* Others: check availability \*\* Up to 85°C depending on application

### APPLICATIONS

- ▶ Appliance program selection
- ▶ Thermostat adjustment
- ▶ HVAC control
- ▶ Consumer electronics
- ▶ Industrial controls
- ▶ Automotive control
- ▶ Home and building automation

# PC-16

## 16-mm carbon panel mount potentiometer

### MECHANICAL SPECIFICATIONS

Mechanical rotation angle	300° ±5°
Electrical rotation angle	280° ±20°
Rotational torque <sup>1</sup>	0.5 to 1.5 Ncm (0.7 to 2.1 in-oz)
Stop torque	> 40 Ncm (>56 in-oz)
Max. Torque nut (binding out)	< 80 Ncm (<112 in-oz)
Thrust and pull in the shaft	> 25 N
Life	
Potentiometer	25.000 cycles <sup>2</sup>
Switch	10.000 cycles

<sup>1</sup> For single models. Tandem, triple and quadruple versions have a higher torque  
<sup>2</sup> One cycle covers forth and back the mechanical angle travel

### ENVIRONMENTAL TESTING

	Test method (CEI 393-1)	ΔR(%)- Piher typical test results
Electrical life	1.000h at 50°C; 0.15W	±5%
Mechanical life Potentiometer* Switch	25.000 cycles at 10 to 15 cpm 10.000 cycles at 1A and 50 VAC	±3% (Rn < 1MΩ)
Temperature coefficient	-25°C; +70°C	±300 ppm/°C (Rn < 100KΩ)
Thermal cycling	16h at 85°C and 2h at -25°C	±2.5%
Damp heat	500h at 40°C and 95% relative humidity (RH)	±5%
Vibration	2h each plane at 10Hz - 55Hz	±2%
Storage	6 month at 23°C ±2°C and 50% RH	±2.5%

\* Only applicable to values ≥ 1KΩ. For lower values please contact us.  
 Out of range values may not comply with these results. Standard test conditions: temperature:23°C ±2°C and 45% to 70% RH

### RECOMMENDED CONNECTIONS

Recommended connection circuit for a position sensor or control application (voltage divider circuit electronic design).

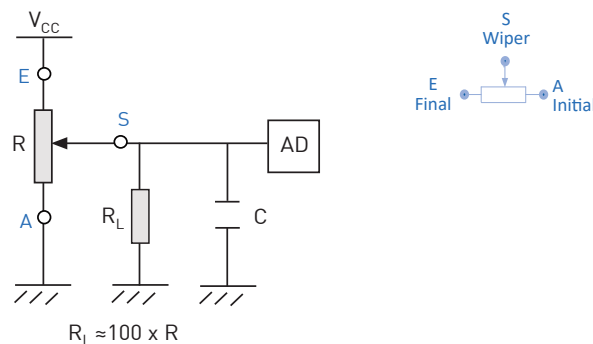

### POWER RATING CURVE

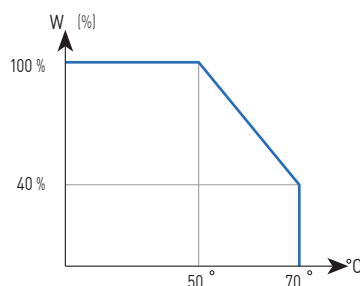

# PC-16

## 16-mm carbon panel mount potentiometer

### HOW TO ORDER

Vertical adjust (Example: PC16SV-10IP12-472A2020-TA)

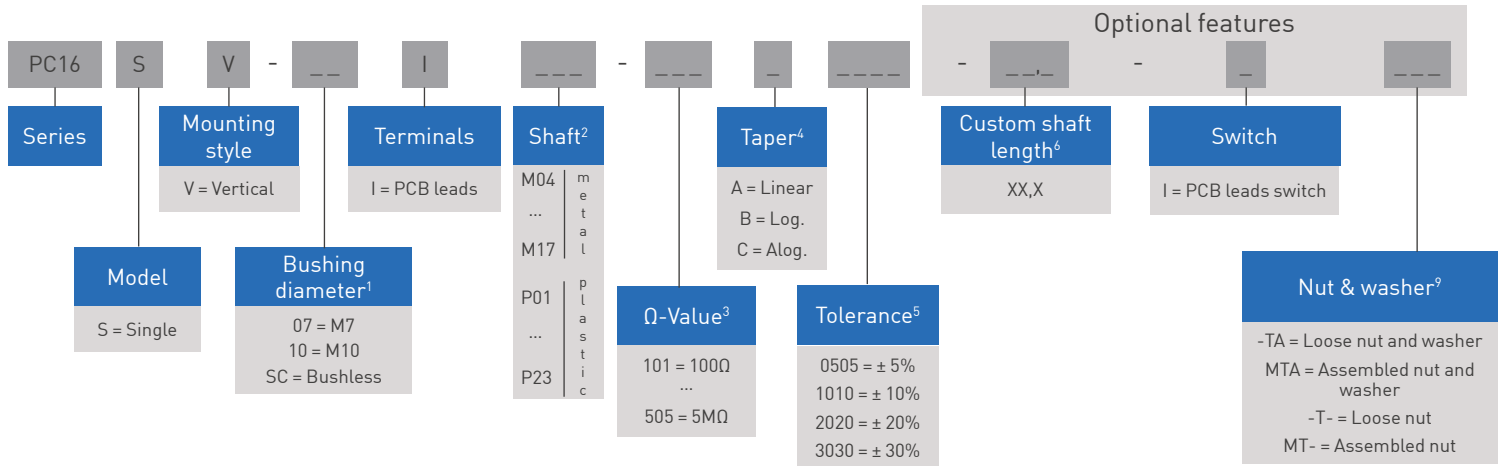

Horizontal adjust (Example: PC16SH-10CP22-105A2020-C-TA )

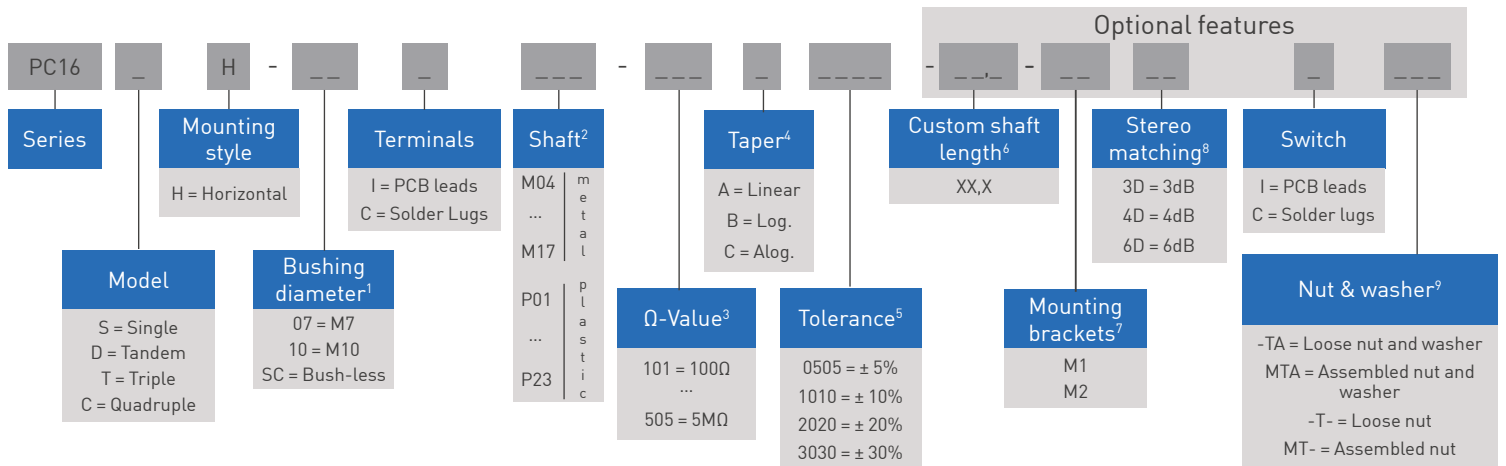

1. Bushings: Type "10" has two parallel flat surfaces to avoid rotation. Bushless option only available for single model

2. Shafts: M07 shaft is only available with M10 bushing. --- = no shaft

3. Ω- Value: XXX - First two digits of Ω-value  
XXX - Number of zeros

If you need "D", "T", "C" models with several resistive values in each module, please contact Piher before ordering

4. Taper: switch option not available with antilog (reverse) taper. Log and Alog tapers available for  $R_n \geq 1K\Omega$

5. Tolerance: custom tolerances available. Please contact Piher for more information

6. Custom shaft length (in mm): recommended maximum: 45mm.

7. Mounting brackets: only applicable for single models "S" without switch

8. Stereo matching: not applicable to single models. Maximum spec.: 3dB for model "D", 4dB for model "T", 6dB for model "C".

9. Not available for bushless type

### ORDER CODE EXAMPLES

PC16SV-10IP16-105A2020-I-TA

Single body vertical adjust potentiometer with M10 bushing, PCB pin leads, "P16" shaft, 1MΩ resistive value, 20% resistive tolerance, switch with PCB pin leads and loose nut and washer.

PC16DH-07CP06-103A1010-15,0-MTA

Double body horizontal adjust potentiometer with M07 bushing, solder lug leads, "P06" shaft type, 10KΩ resistive value, 10% resistive tolerance, shaft cut to L=15mm and factory-assembled nut and washer.

# PC-16

## 16-mm carbon panel mount potentiometer

### STANDARD CONFIGURATION

Shaft length	Standard length according to shaft's drawing
Mounting brackets	None
Stereo matching	Only on request
Switch	None
Nut and washer	None

### MODELS

PC-16 S/D/T/C...H...	PC-16 SV .....



Download STEP files here: <https://piher.net/piher/?p=938>

### METALLIC SUPPORT (MOUNTING BRACKETS)

PC-16 SH.....M1	PC-16 SH.....M2

# PC-16

## 16-mm carbon panel mount potentiometer

### BUSHINGS

07

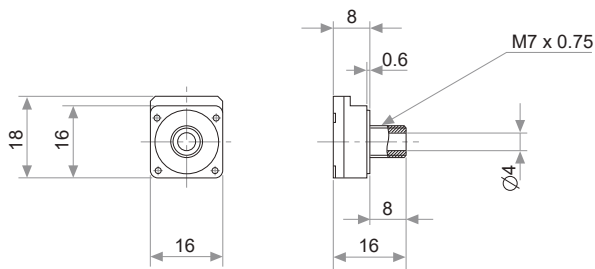

10

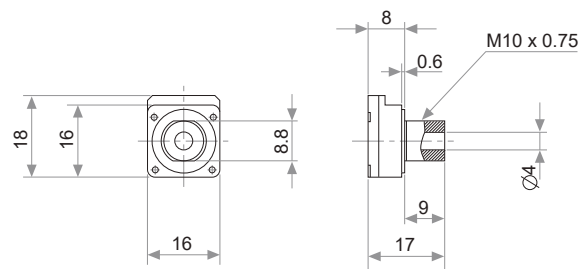

### SC (BUSHLESS)

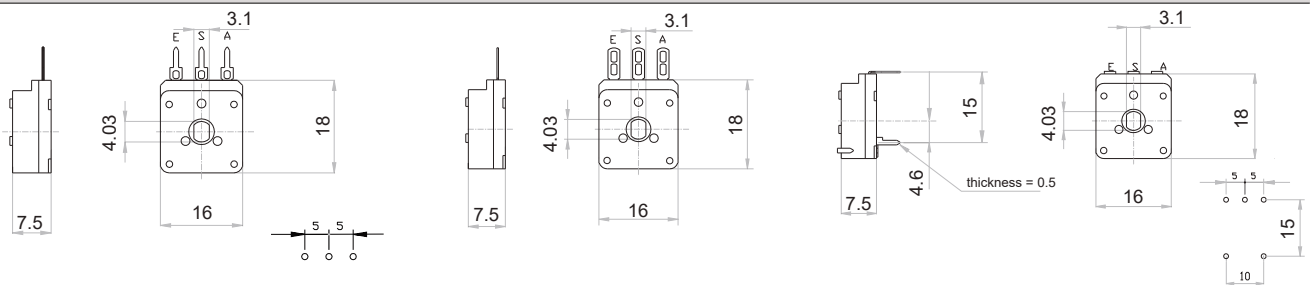

### TERMINALS

C - Solder Lugs

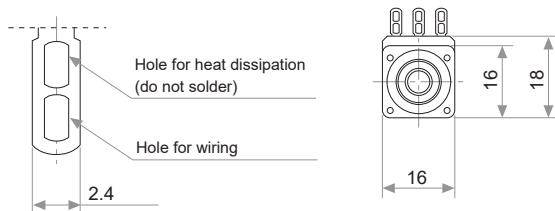

I = PCB

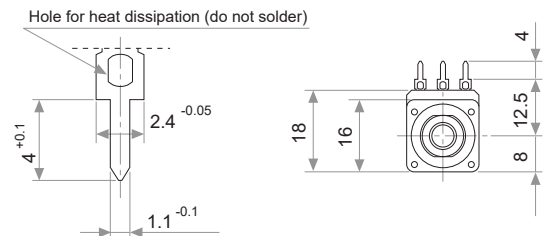

### NUTS & WASHERS

BUSHING 10

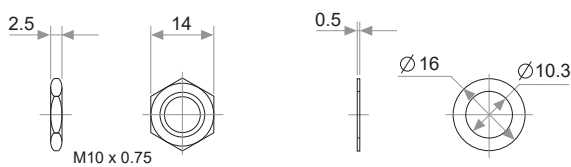

BUSHING 07

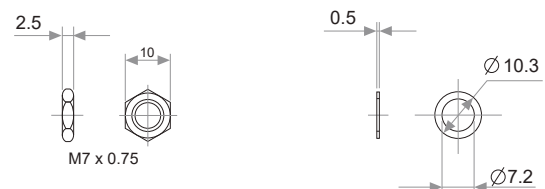

### TAPERS

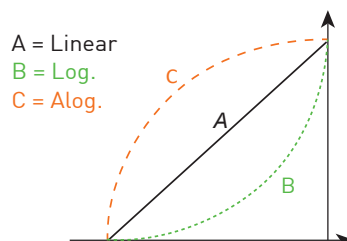

For more information on custom tapers contact Piher Sensing Systems.

# PC-16

## 16-mm carbon panel mount potentiometer

### OPEN CIRCUIT FEATURE

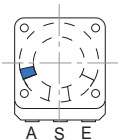

PCI  
Cut track at the beginning of the travel.

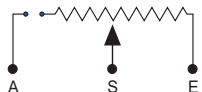

PCF  
Cut track at the end of the travel.

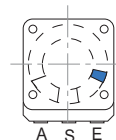
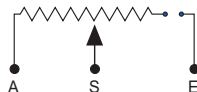

CCW on-off (A)

CW on-off (E)

A = Initial S = Wiper E = Final.  
PCI, PCF and other configurations available upon request. Check the ordering code with Piher.

### PACKAGING

Bulk



Box dimensions (mm): 250x160x95

Units per box: 100 pcs

(Triple and quadruple models with switch: 50pcs)

### SWITCH

PC-16S ... H I / C

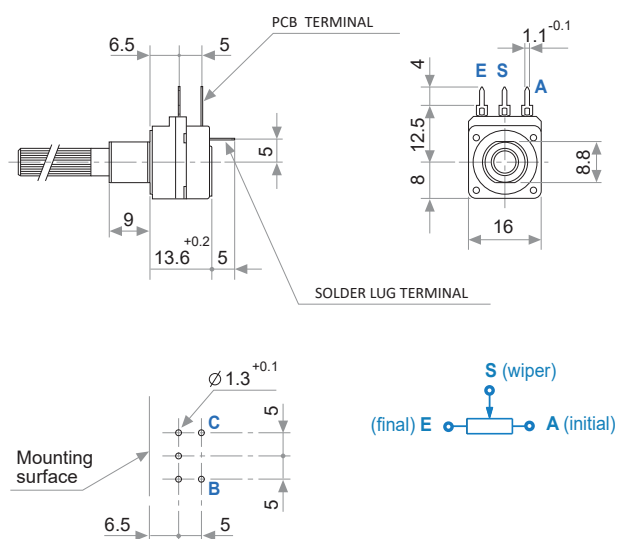

PC-16SV ... I

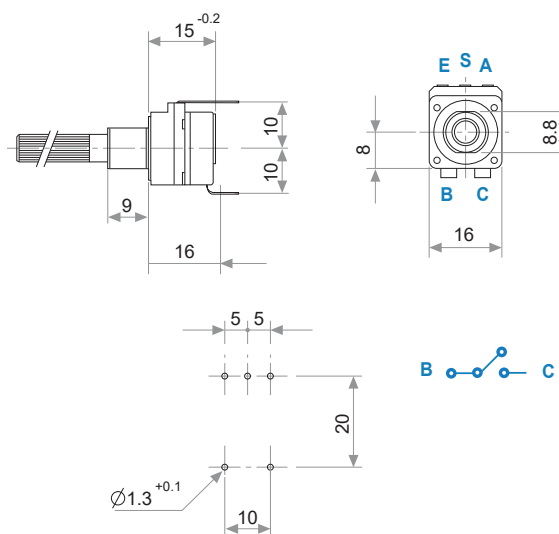

### SWITCH SPECIFICATIONS

Nominal current	1A, 250 VAC
Contact resistance (initial)	10 mΩ
Operating torque	1 to 3 Ncm [1.4 to 4.2 in-oz]
Operating angle	30°±5°
Test voltage	500 V

### 360° CONTINUOUS ROTATION

### METAL HOUSING + STOP POSITIONS

### CUSTOMIZATION POSSIBILITIES

STM-15

T-16

Potentiometer + wires + connector



Check available models at [www.piher.net](http://www.piher.net)

# PC-16

## 16-mm carbon panel mount potentiometer

### METALIC SHAFTS

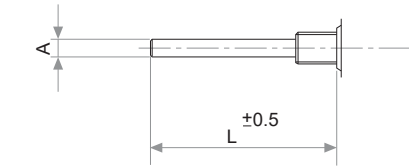

Code	A	L
M04	4	45
M06	6	45
M07	6.35	45

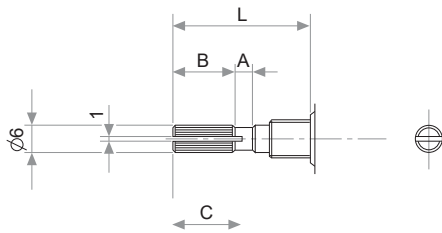

Code	A	B	C	L
M11	2	5	7	15
M12	2	10	11	20
M13	4	12	14	25
M14	4	12	14	30
M15	4	12	14	35
M16	4	12	14	40
M17	4	12	14	45

### Models upon request

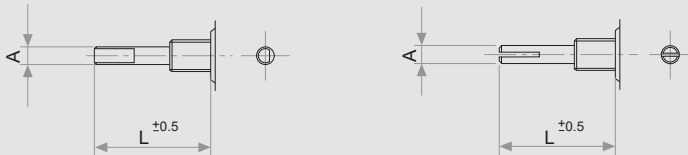

A
Ø 4
Ø 6
Ø 6.35

### PLASTIC SHAFTS Ø3.1

P09

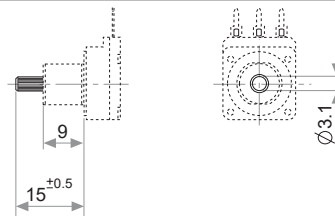

### PLASTIC SHAFTS Ø4

P01

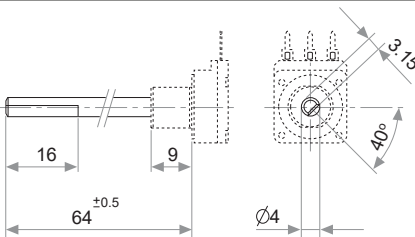

P02

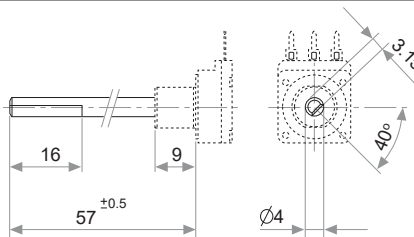

P04

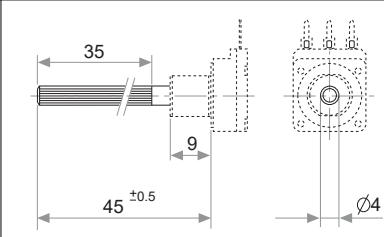

P07

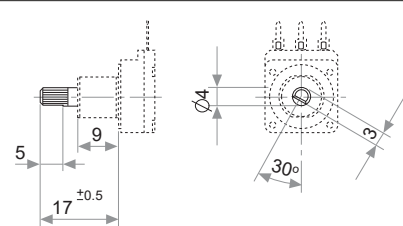

P08

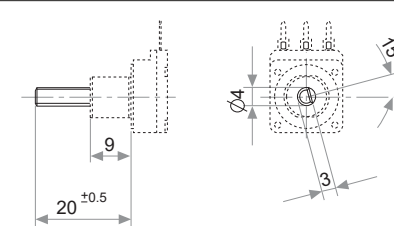

P10

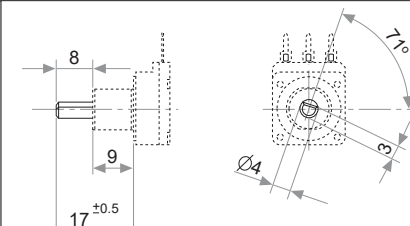

# PC-16

## 16-mm carbon panel mount potentiometer

### PLASTIC SHAFTS Ø4

P21

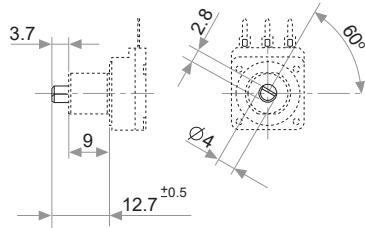

### PLASTIC SHAFTS Ø6

P05

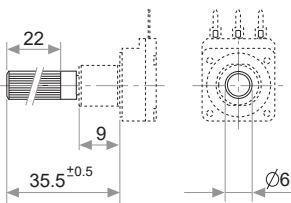

P06

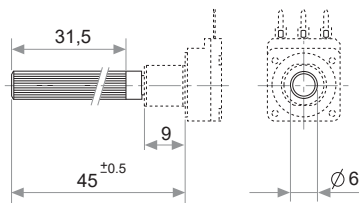

P11

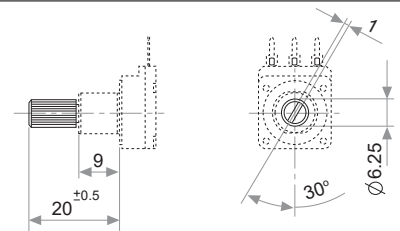

P12

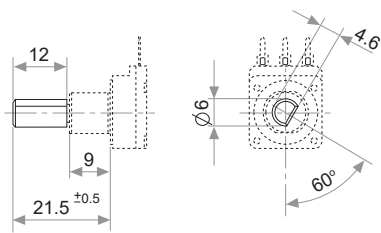

P13

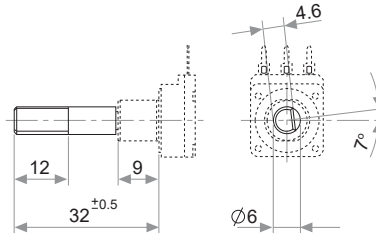

P14

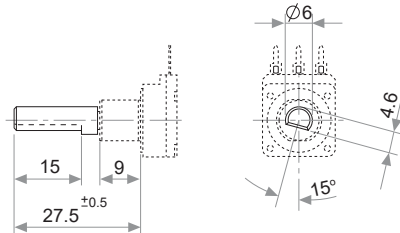

P15

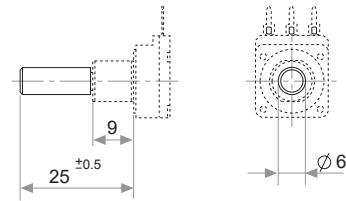

P16

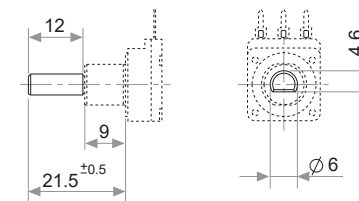

P17

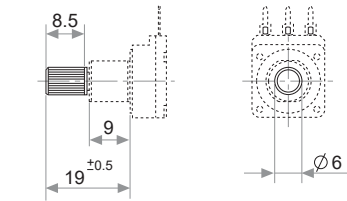

P18

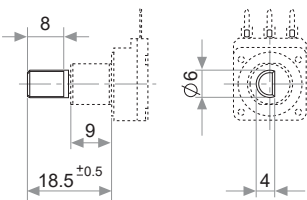

P19

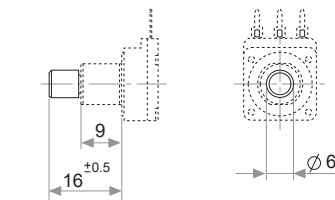

P20

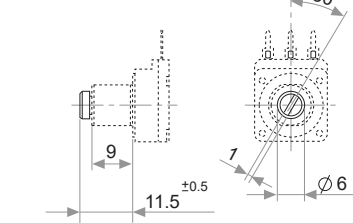

P22

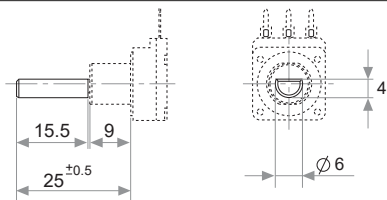

P23

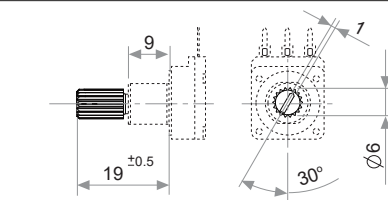

18 teeth knurl with arrow shape shaft

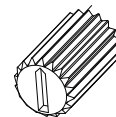

Shaft position shown full CCW. Any other position for plastic shafts has to be shifted n times 24°. Other positions upon request..



# PC-16

## 16-mm carbon panel mount potentiometer

### OUR ADVANTAGE

- ▶ Leading-edge innovative position sensing solutions
  - ▷ Contactless (Hall-effect and Inductive Technology)
  - ▷ Contacting (Potentiometers, Printed Electronics)
- ▶ Engineering design-in support
- ▶ All our products can be customized to fit target application and customer requirement
- ▶ Capability to move seamlessly from development to true high-volume production
- ▶ A global footprint with global engineering and commercial support
- ▶ One-stop shop not limited to position sensors (temperature, pressure, gas,...) through group collaboration
- ▶ Flexibility and entrepreneurship of a medium-sized company with the backing of Amphenol Corporation



Please always use the latest updated datasheets and 3D models published on our website.

#### Disclaimer:

The product information in this catalog is for reference purposes. Please consult for the most up to date and accurate design information. Piher Sensors & Controls S.A., its affiliates, agents, and employees, and all persons acting on its or their behalf (collectively, "Piher"), disclaim any and all liability for any errors, inaccuracies or incompleteness contained herein or in any other disclosure relating to any product described herein. Piher disclaims any and all liability arising out of the use or application of any product described herein or of any information provided herein to the maximum extent permitted by law. The product specifications do not expand or otherwise modify Piher's terms and conditions of sale, including but not limited to the warranty expressed therein, which apply to these products. No license, express or implied, by estoppel or otherwise, to any intellectual property rights is granted by this document or by any conduct of Piher. The products shown herein are not designed for use in medical, life-saving, or life-sustaining applications unless otherwise expressly indicated. Customers using or selling Piher products not expressly indicated for use in such applications do so entirely at their own risk and agree to fully indemnify Piher for any damages arising or resulting from such use or sale. Please contact authorized Piher personnel to obtain written terms and conditions regarding products designed for such applications. Product names and markings noted herein may be trademarks of their respective owners. Information contained in and/or attached to this catalogue may be subject to export control regulations of the European Community, USA, or other countries. Each recipient of this document is responsible to ensure that usage and/or transfer of any information contained in this document complies with all relevant export control regulations. If you are in any doubt about the export control restrictions that apply to this information, please contact the sender immediately. For any Piher Exports, Note: All products / technologies are EAR99 Classified commodities. Exports from the United States are in accordance with the Export Administration Regulations. Diversion contrary to US Law is prohibited.

### CONTACT

**Piher Sensing Systems**  
Polígono Industrial Municipal  
Vial T2, Nº22  
31500 Tudela  
Spain

[sales@piher.net](mailto:sales@piher.net)

Europe: +34 948 820 450  
Americas: +1 636 251 0855  
Asia Pacific: +65 9641 8886  
India: +91 9538 686 586

Rev-07/2022 © 2022 Piher Sensors & Controls S.A.