

DPDT SWITCH GaAs MMIC

■ GENERAL DESCRIPTION

NJG1602HE3 is a GaAs high power DPDT switch MMIC for antenna switch of tri- and dual-mode cellular phone application such as CDMA, GPS and PCS.

This switch features low loss, high isolation at high power.

This device includes logic decoder function, and can be operated by 1 bit control signal for path switching.

The ultra small & ultra thin USB12 package is adopted.

■ PACKAGE OUTLINE

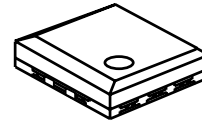

■ FEATURES

- Low voltage operation +2.5V min.
- Pin at 0.2dB compression point 36dBm typ. @f=0.9GHz, $V_{CTL}=2.7V$
- Low insertion loss 0.3dB typ. @f=0.9GHz, $P_{IN}=25dBm$, $V_{CTL}=2.7V$
0.55dB typ. @f=1.9GHz, $P_{IN}=25dBm$, $V_{CTL}=2.7V$
- High isolation 21dB typ. @f=0.9GHz, $P_{IN}=25dBm$, $V_{CTL}=2.7V$
15dB typ. @f=1.9GHz, $P_{IN}=25dBm$, $V_{CTL}=2.7V$
- Low current consumption 17uA typ. @f=0.9GHz, $P_{IN}=25dBm$, $V_{CTL}=2.7V$
- Ultra small & ultra thin package USB12-E3 (Package size: 2.35x2.35x0.75mm)

■ PIN CONFIGURATION

USB12Type
(Top View)

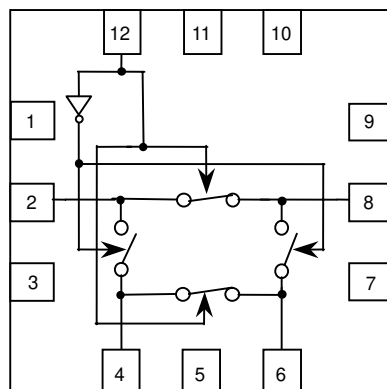

Pin connection

1. VDD
2. P1
3. GND
4. P2
5. GND
6. P3
7. GND
8. P4
9. GND
10. GND
11. GND
12. CTL

■ TRUTH TABLE

“H”=CTL(H), “L”=CTL(L)

| CTL | H | L |
|--------------|-----|-----|
| P1-P4, P2-P3 | ON | OFF |
| P1-P2, P3-P4 | OFF | ON |

NOTE: Please note that any information on this catalog will be subject to change.

NJG1602HE3

■ ABSOLUTE MAXIMUM RATINGS

($T_a=+25^{\circ}\text{C}$, $Z_s=Z_l=50\Omega$)

| PARAMETER | SYMBOL | CONDITIONS | CONDITIONS | UNITS |
|-------------------|-----------|--|------------|--------------------|
| RF Input Power | P_{IN} | $V_{DD}=2.7\text{V}$, $CTL=0\text{V}/2.7\text{V}$ | 37 | dBm |
| Supply Voltage | V_{DD} | VDD terminal | 7.5 | V |
| Control Voltage | V_{CTL} | CTL terminal | 7.5 | V |
| Power Dissipation | P_D | | 250 | mW |
| Operating Temp. | T_{opr} | | -40~+85 | $^{\circ}\text{C}$ |
| Storage Temp. | T_{stg} | | -55~+150 | $^{\circ}\text{C}$ |

■ ELECTRICAL CHARACTERISTICS

(General conditions: $T_a=+25^{\circ}\text{C}$, $Z_s=Z_l=50\Omega$, $V_{DD}=2.7\text{V}$, $CTL(L)=0\text{V}$, $CTL(H)=2.7\text{V}$)

| PARAMETERS | SYMBOL | CONDITIONS | MIN | TYP | MAX | UNITS |
|-----------------------------------|---------------------|---|-----|------|----------|---------------|
| Operating Current | I_{DD} | $P_{IN}=25\text{dBm}$ | - | 70 | 100 | μA |
| Supply Voltage | V_{DD} | | - | 2.7 | 5.5 | V |
| Control Voltage (LOW) | CTL(L) | | 0 | - | 0.8 | V |
| Control Voltage (HIGH) | CTL(H) | | 2.5 | 2.7 | V_{DD} | V |
| Control Current | I_{CTL} | $f=0.9\text{GHz}$, $P_{IN}=25\text{dBm}$ | - | 17 | 30 | μA |
| Insertion Loss 1 | LOSS1 | $f=0.9\text{GHz}$, $P_{IN}=25\text{dBm}$ | - | 0.3 | 0.4 | dB |
| Insertion Loss 2 | LOSS2 | $f=1.9\text{GHz}$, $P_{IN}=25\text{dBm}$ | - | 0.55 | 0.7 | dB |
| Isolation 1 | ISL1 | $f=0.9\text{GHz}$, $P_{IN}=25\text{dBm}$ | 20 | 21 | - | dB |
| Isolation 2 | ISL2 | $f=1.9\text{GHz}$, $P_{IN}=25\text{dBm}$ | 14 | 15 | - | dB |
| Pin at 0.2dB Compression Point | $P_{-0.2\text{dB}}$ | $f=1.9\text{GHz}$ | 33 | 36 | - | dBm |
| 2nd Harmonics 1 | $2f_0(1)$ | $f=0.9\text{GHz}$, $P_{IN}=25\text{dBm}$ | - | -80 | -65 | dBc |
| 2nd Harmonics 2 | $2f_0(2)$ | $f=1.9\text{GHz}$, $P_{IN}=25\text{dBm}$ | - | -75 | -70 | dBc |
| 3rd Harmonics 1 | $3f_0(1)$ | $f=0.9\text{GHz}$, $P_{IN}=25\text{dBm}$ | - | -75 | -60 | dBc |
| 3rd Harmonics 2 | $3f_0(2)$ | $f=1.9\text{GHz}$, $P_{IN}=25\text{dBm}$ | - | -70 | -60 | dBc |
| Input 3rd order intercept Point 1 | IIP3(1) | $f=900+901\text{MHz}$, $P_{in}=25\text{dBm}$ *1 | 56 | 62 | - | dBm |
| Input 3rd order intercept Point 2 | IIP3(2) | $f=1900+1901\text{MHz}$, $P_{in}=25\text{dBm}$ *1 | 54 | 60 | - | dBm |
| VSWR | $VSWR_i$ | on-state ports, $f=0.9\text{GHz}$ | - | 1.1 | 1.4 | |
| Switching time | T_{SW} | $f=0.1\sim 2.5\text{GHz}$ | - | 1.2 | - | μs |

*1: The input IP3 is defined as following equation.

$$IIP3=(3 \times P_{out} - IM3) / 2 + LOSS$$

■ TERMINAL INFORMATION

| No. | SYMBOL | DESCRIPTION |
|-----|--------|---|
| 1 | VDD | Positive voltage supply terminal. The positive voltage (+2.5~+5.5V) have to be supplied. Please connect a bypass capacitor with GND terminal for excellent RF performance. |
| 2 | P1 | RF port. This port is connected with P4 port by controlling 12pin-CTL(H) (+2.5~+VDD). This port is connected with P2 port by controlling 12pin- CTL(L) (0~+0.8V) . A DC cut capacitor 56pF is required at this terminal to block DC voltage of inner circuit. |
| 3 | GND | Ground terminal. Please connect this terminal with ground plane as close as possible for excellent RF performance. |
| 4 | P2 | RF port. This port is connected with P3 port by controlling 12pin- CTL(L) (0.2~+0.8V). This port is connected with P3 port by controlling 12pin- CTL(H)(+2.5~+VDD). A DC cut capacitor 56pF is required at this terminal to block DC voltage of inner circuit. |
| 5 | GND | Ground terminal. Please connect this terminal with ground plane as close as possible for excellent RF performance. |
| 6 | P3 | RF port. This port is connected with P2 port by controlling 12pin- CTL(H) (+2.5~+VDD). This port is connected with P4 port by controlling 12pin-V _{CTL(L)} (0~+0.8V). A DC cut capacitor 56pF is required at this terminal to block DC voltage of inner circuit. |
| 7 | GND | Ground terminal. Please connect this terminal with ground plane as close as possible for excellent RF performance. |
| 8 | P4 | RF port. This port is connected with P1 port by controlling 12pin- CTL(H) (+2.5~+VDD). This port is connected with P3 port by controlling 12pin- CTL(L) (0~+0.8V). A DC cut capacitor 56pF is required at this terminal to block DC voltage of inner circuit. |
| 9 | GND | Ground terminal. Please connect this terminal with ground plane as close as possible for excellent RF performance. |
| 10 | GND | Ground terminal. Please connect this terminal with ground plane as close as possible for excellent RF performance. |
| 11 | GND | Ground terminal. Please connect this terminal with ground plane as close as possible for excellent RF performance. |
| 12 | CTL | Control signal input terminal. This terminal is set to High-Level (+2.5V~VDD) or Low-Level (0~+0.8V). |

NJG1602HE3

■ ELECTRICAL CHARACTERISTICS

(0.1~3.0GHz, with application circuit, Losses of external circuit are excluded)

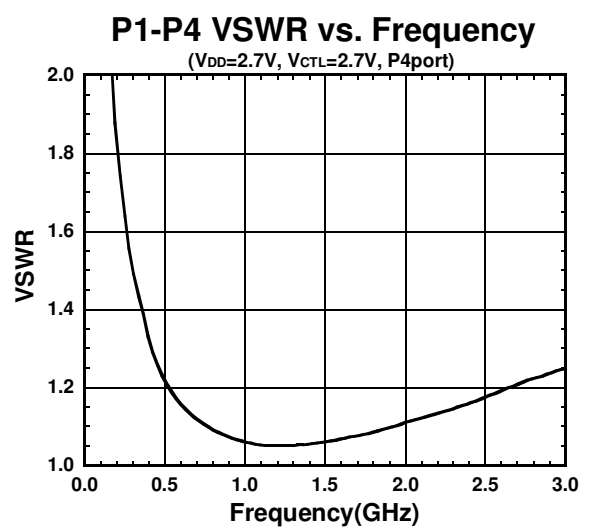
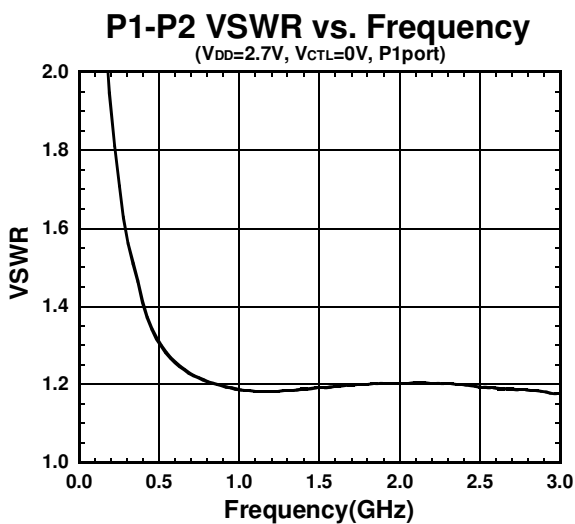
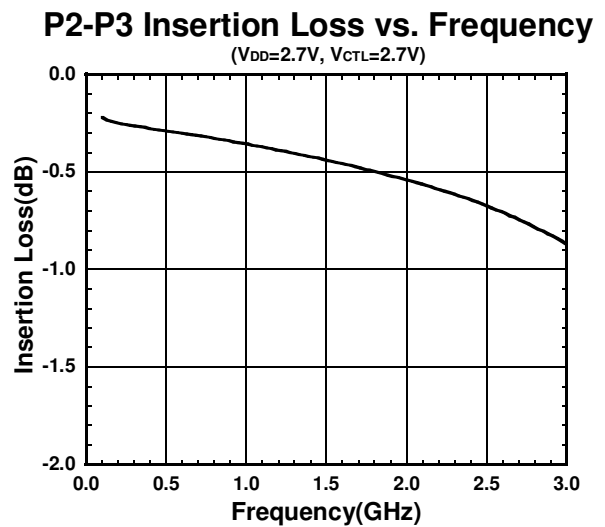
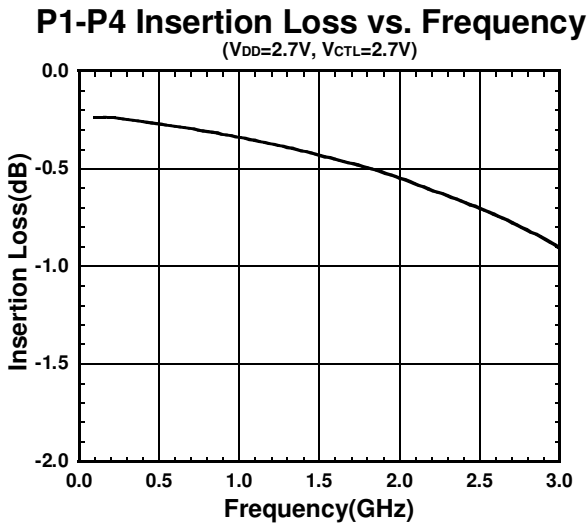
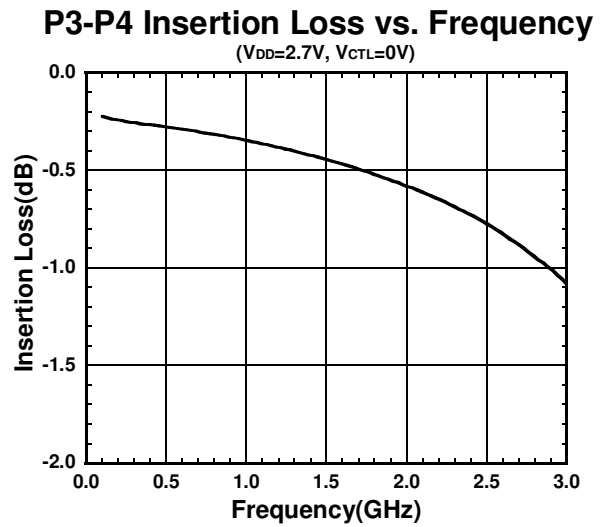
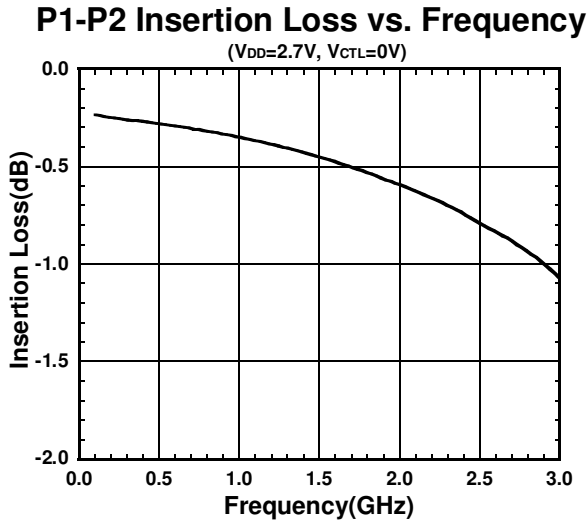

■ ELECTRICAL CHARACTERISTICS

(0.1~3.0GHz, with application circuit, Losses of external circuit are excluded)

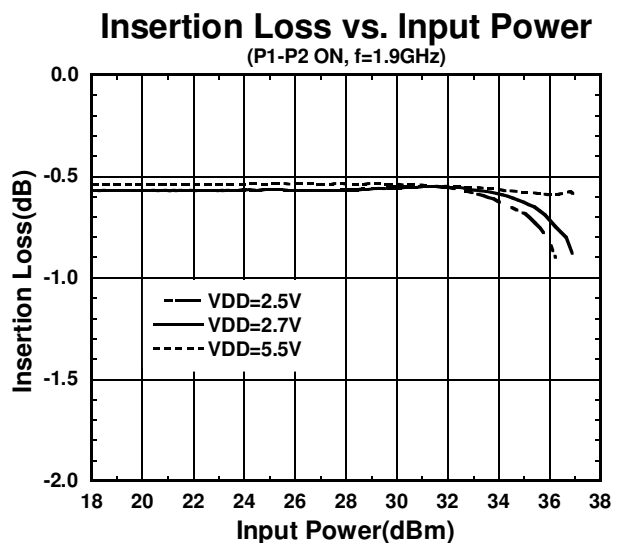
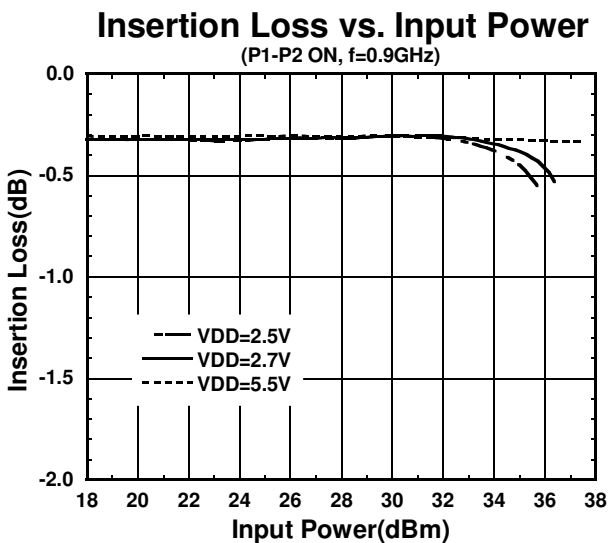
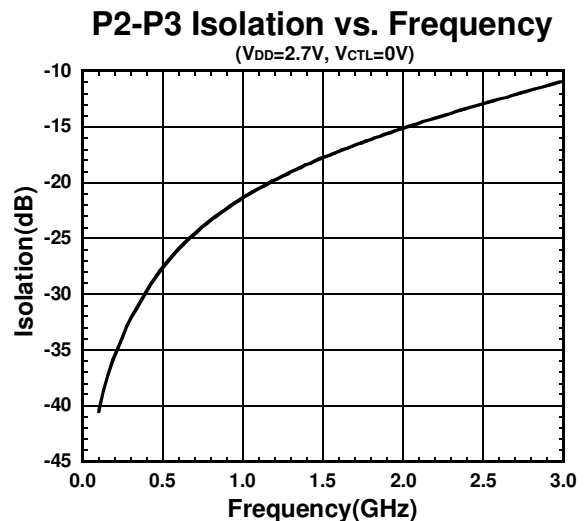
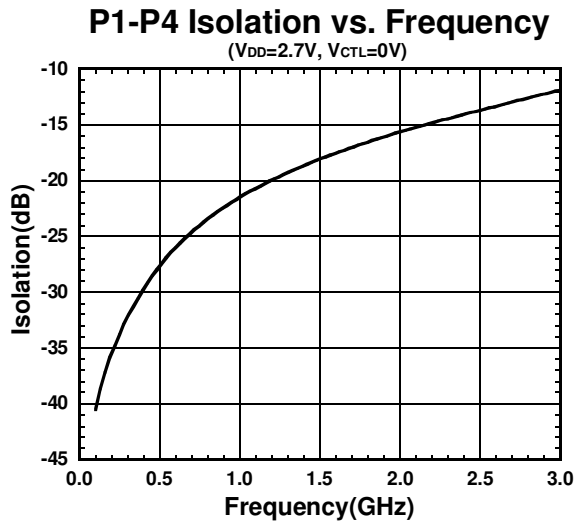
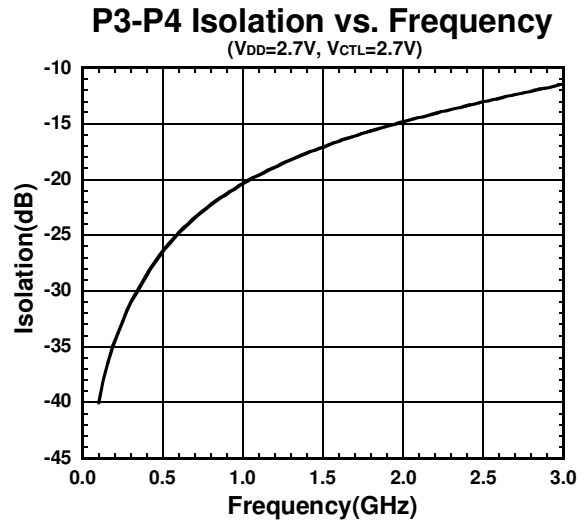
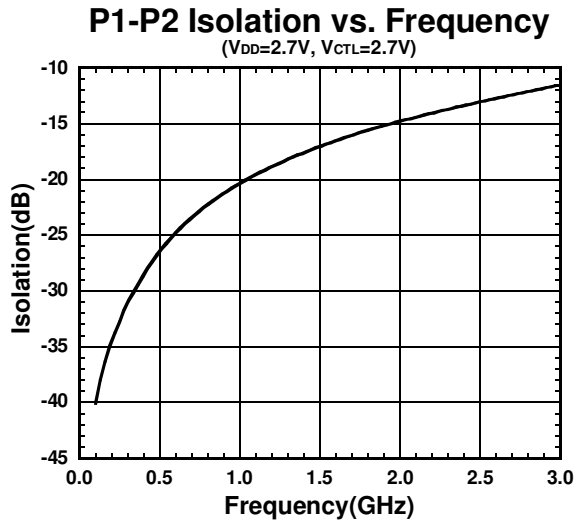

NJG1602HE3

■ ELECTRICAL CHARACTERISTICS (with application circuit)

IDD vs. Input Power
(P1-P2 ON, f=0.9GHz)

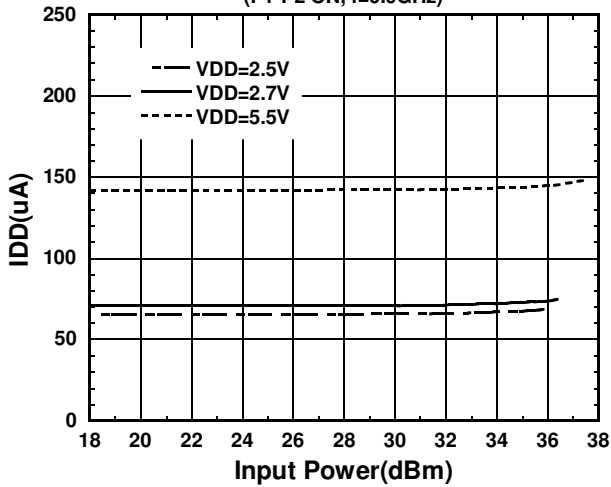

IDD vs. Input Power
(P1-P2 ON, f=1.9GHz)

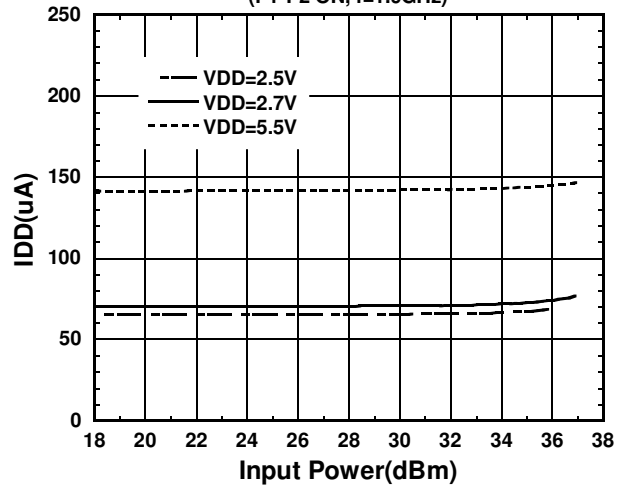

Isolation vs. Input Power
(P1-P4 ON, CTL=2.7V, f=0.9GHz)

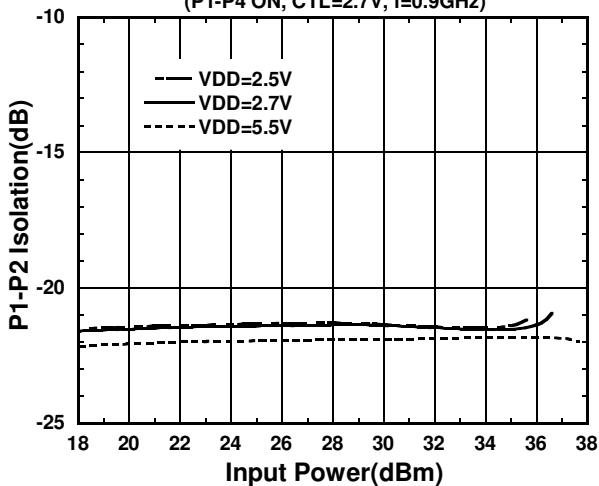

Isolation vs. Input Power
(P1-P4 ON, CTL=2.7V, f=1.9GHz)

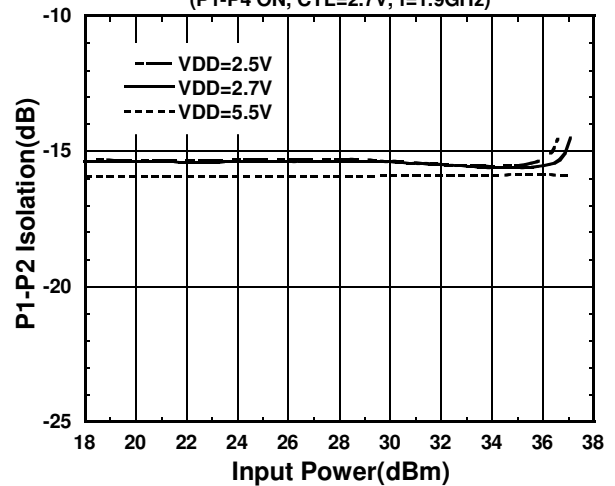

■ ELECTRICAL CHARACTERISTICS (with application circuit)

2nd Harmonics vs. Input Power (P1-P2 ON, f=0.9GHz)

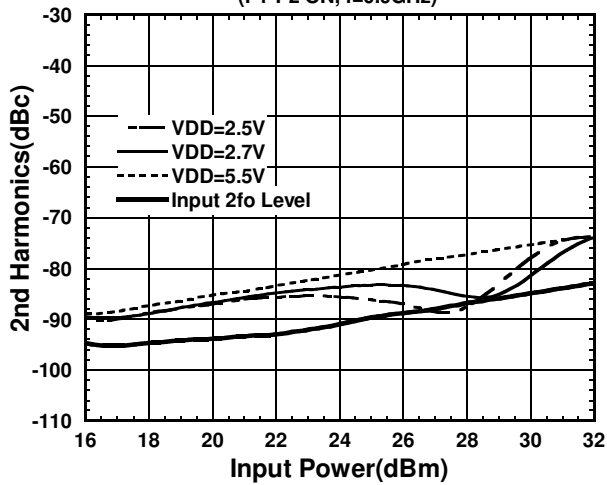

2nd Harmonics vs. Input Power (P1-P2 ON, f=1.9GHz)

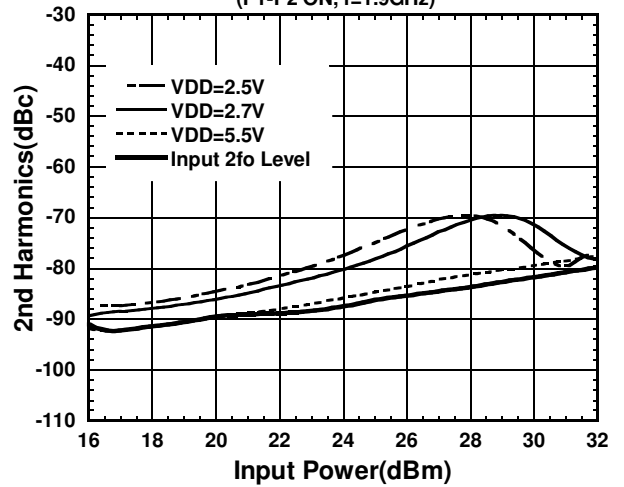

3rd Harmonics vs. Input Power (P1-P2 ON, f=0.9GHz)

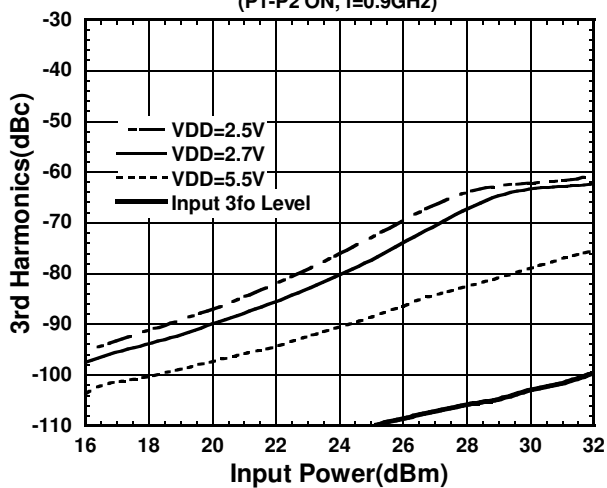

3rd Harmonics vs. Input Power (P1-P2 ON, f=1.9GHz)

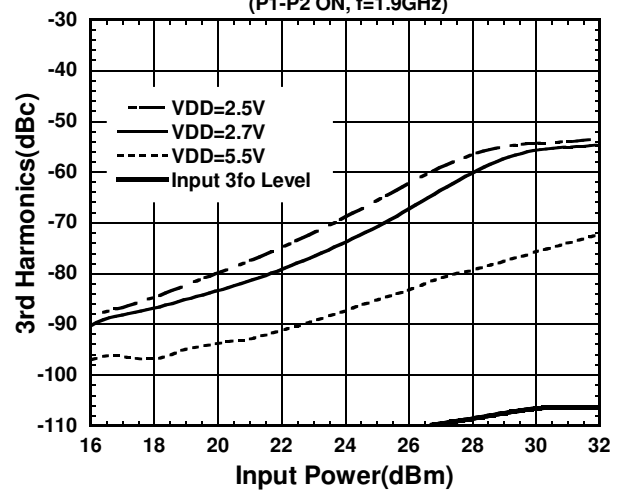

NJG1602HE3

ELECTRICAL CHARACTERISTICS (with application circuit)

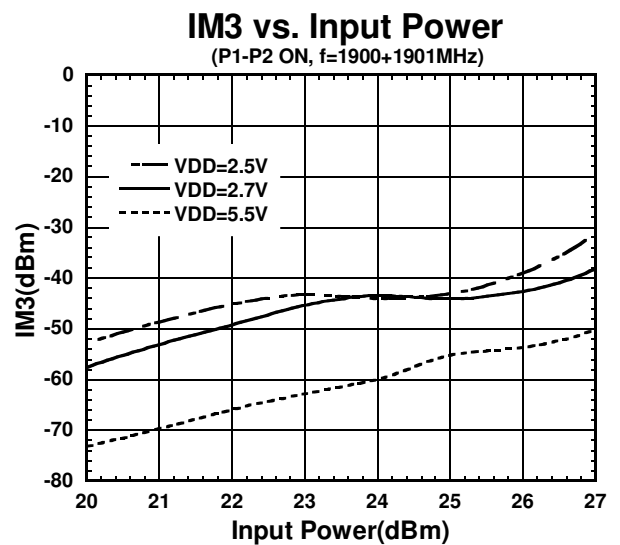
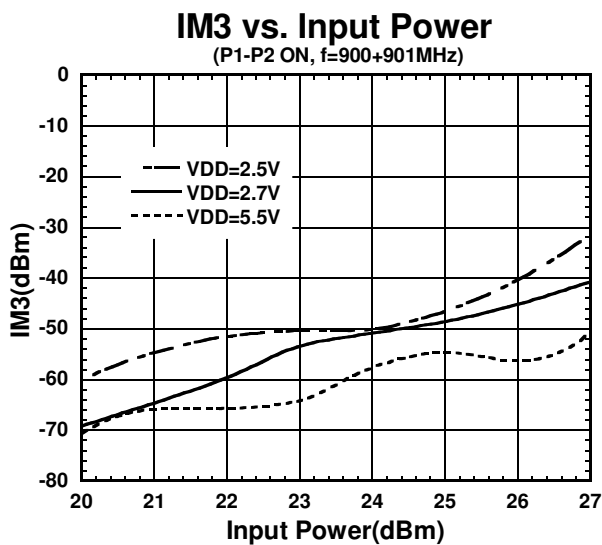
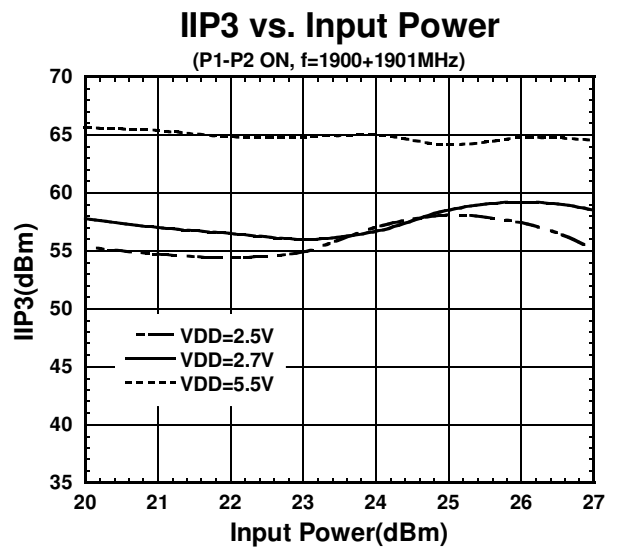
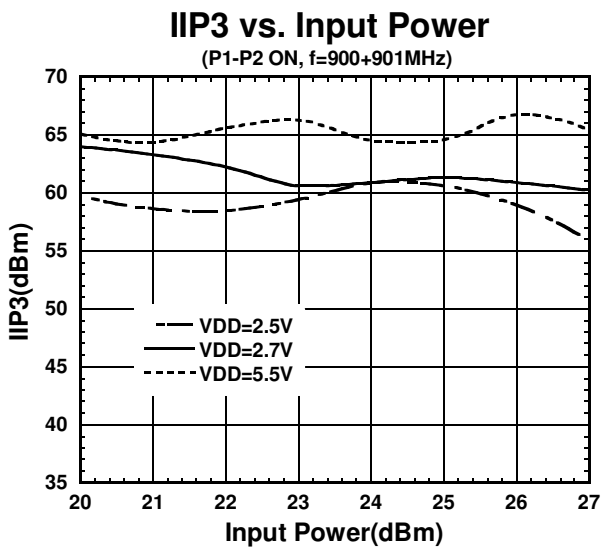
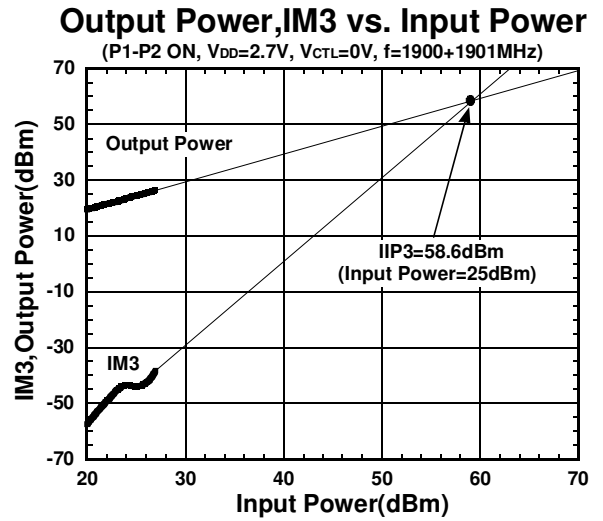
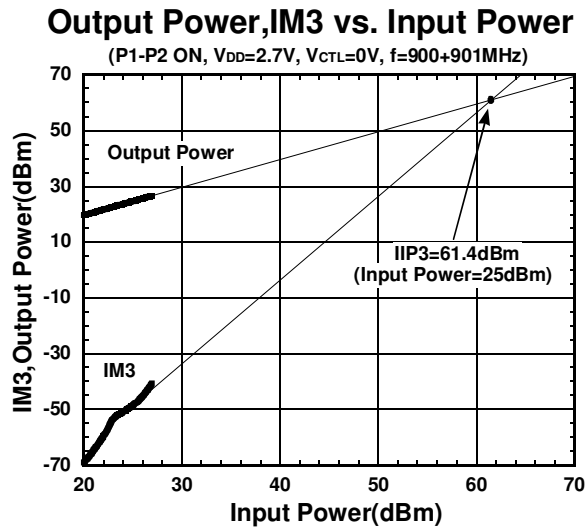

■ ELECTRICAL CHARACTERISTICS

(with application circuit, Losses of external circuit are excluded)

Insertion Loss vs. Ambient Temperature

(P1-P2 ON, f=0.9GHz, Pin=25dBm)

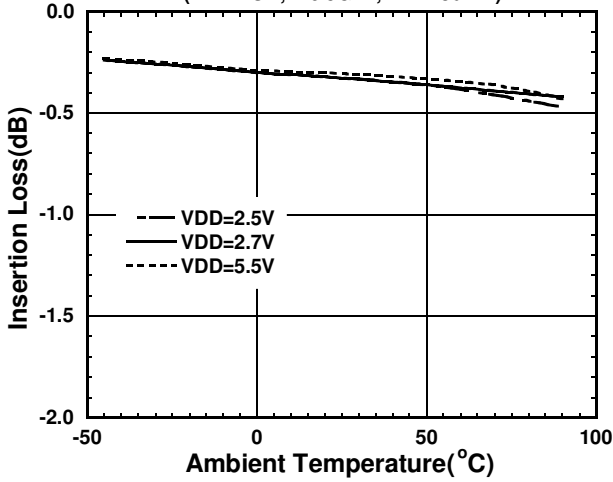

Insertion Loss vs. Ambient Temperature

(P1-P2 ON, f=1.9GHz, Pin=25dBm)

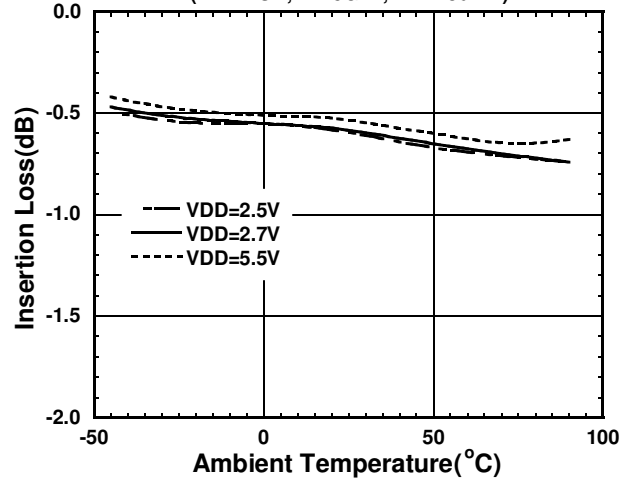

■ ELECTRICAL CHARACTERISTICS

(with application circuit)

IDD vs. Ambient Temperature

(P1-P2 ON, f=0.9GHz, Pin=25dBm)

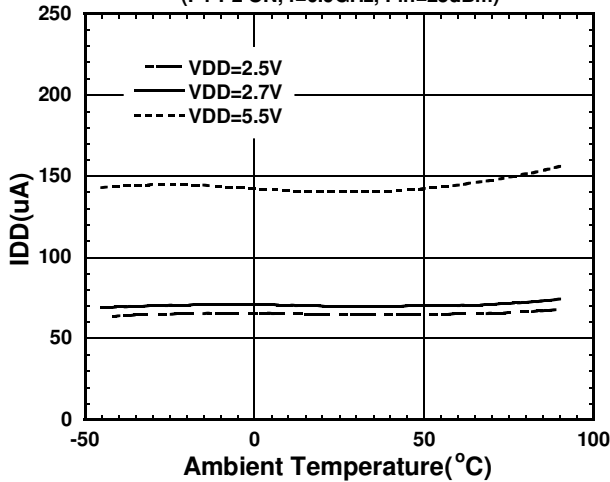

IDD vs. Ambient Temperature

(P1-P2 ON, f=1.9GHz, Pin=25dBm)

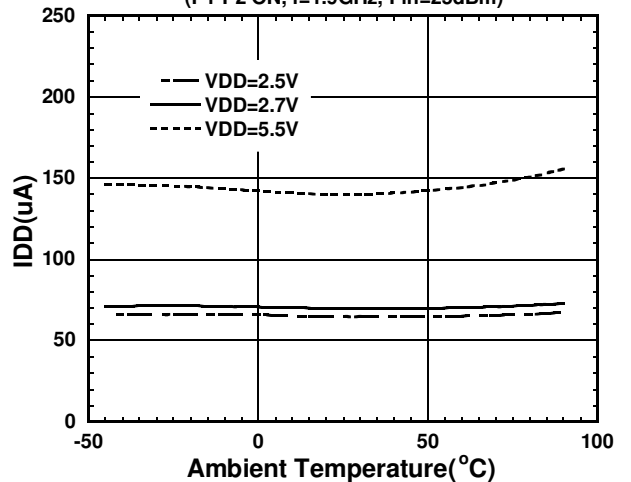

Isolation vs. Ambient Temperature

(P1-P4 ON, f=0.9GHz, Pin=25dBm)

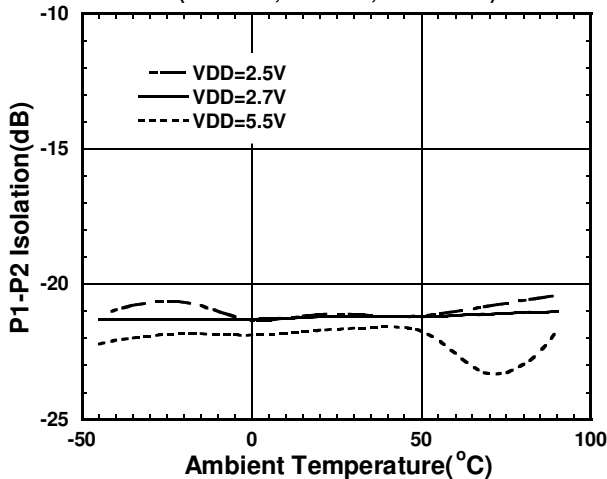

Isolation vs. Ambient Temperature

(P1-P4 ON, f=1.9GHz, Pin=25dBm)

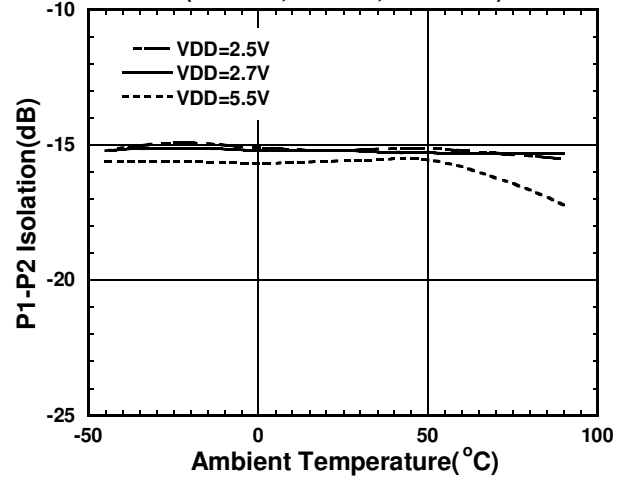

NJG1602HE3

ELECTRICAL CHARACTERISTICS

(with application circuit)

P-0.2dB vs. Ambient Temperature

(P1-P2 ON, f=0.9GHz)

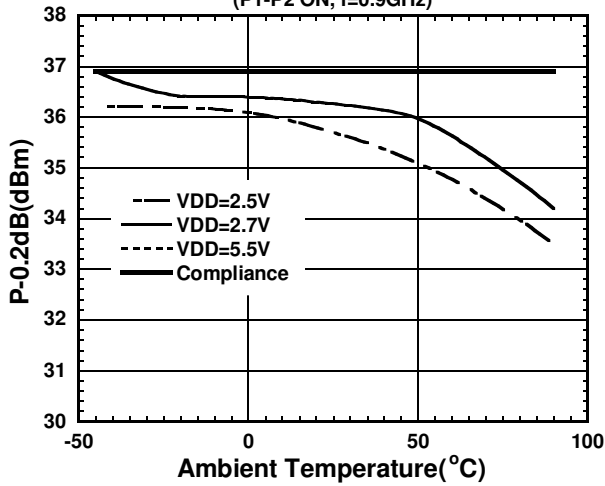

P-0.2dB vs. Ambient Temperature

(P1-P2 ON, f=1.9GHz)

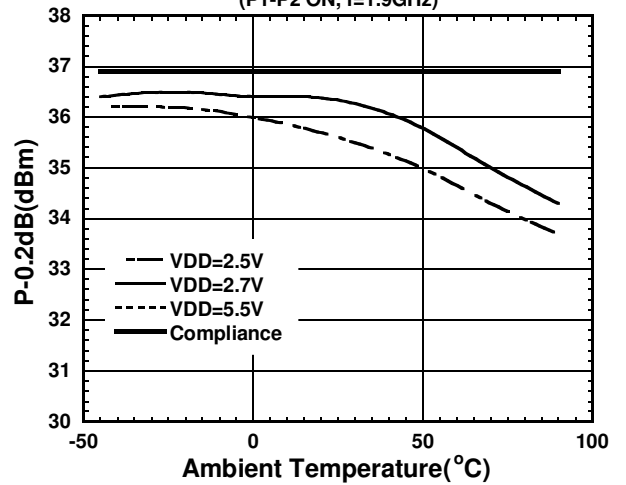

2nd Harmonics vs. Ambient Temperature

(P1-P2 ON, f=0.9GHz, Pin=25dBm)

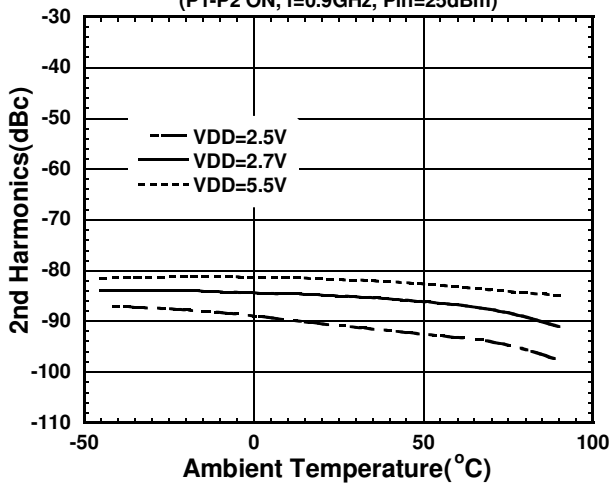

2nd Harmonics vs. Ambient Temperature

(P1-P2 ON, f=1.9GHz, Pin=25dBm)

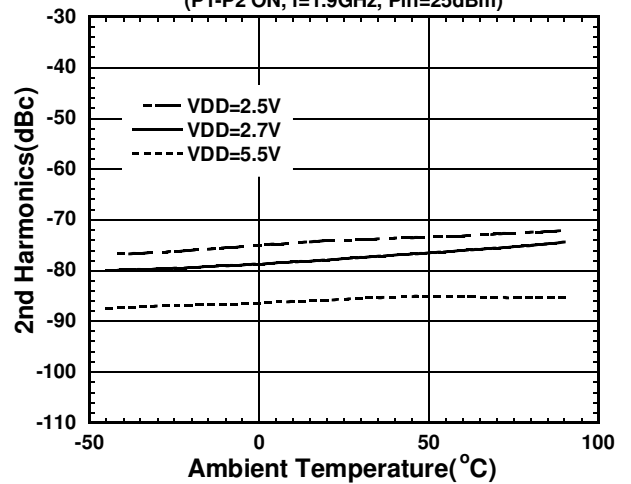

3rd Harmonics vs. Ambient Temperature

(P1-P2 ON, f=0.9GHz, Pin=25dBm)

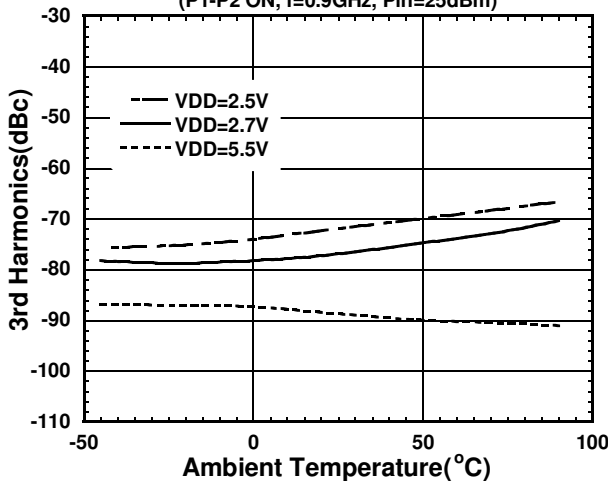

3rd Harmonics vs. Ambient Temperature

(P1-P2 ON, f=1.9GHz, Pin=25dBm)

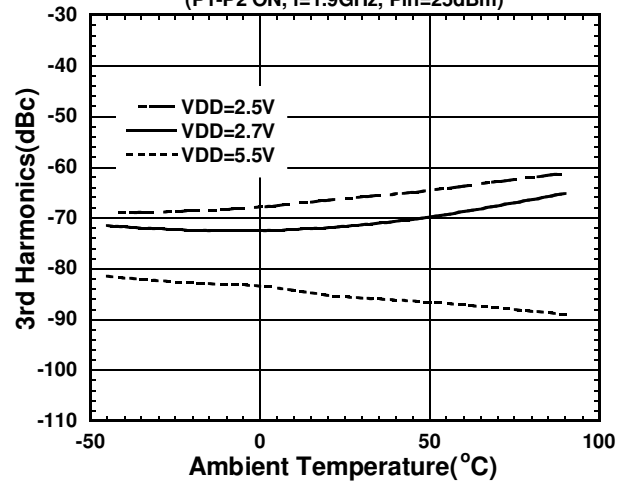

■ ELECTRICAL CHARACTERISTICS (with application circuit)

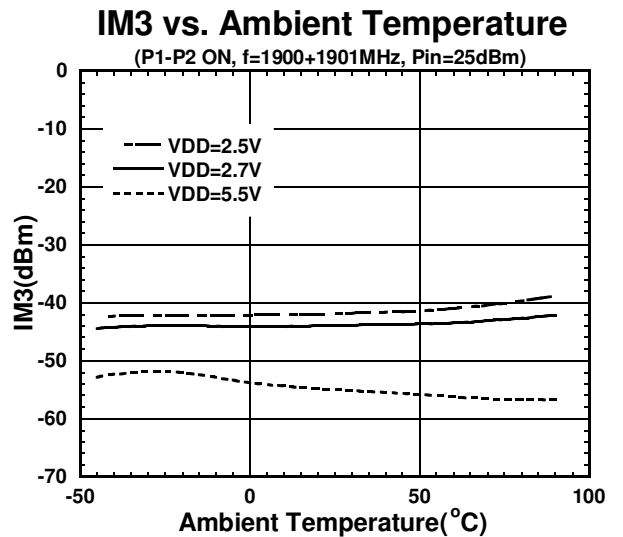
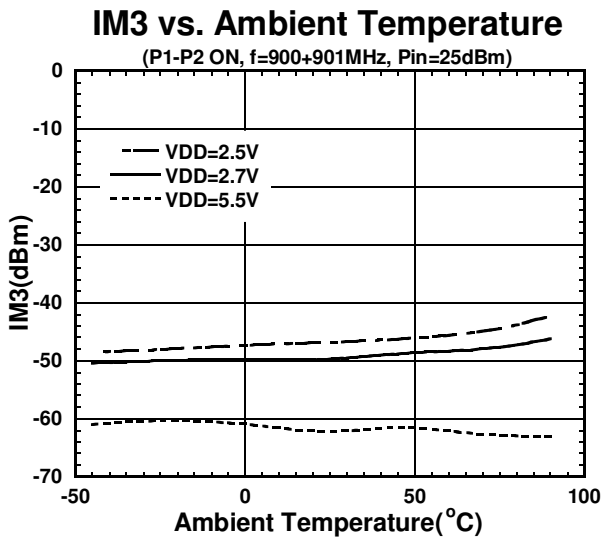
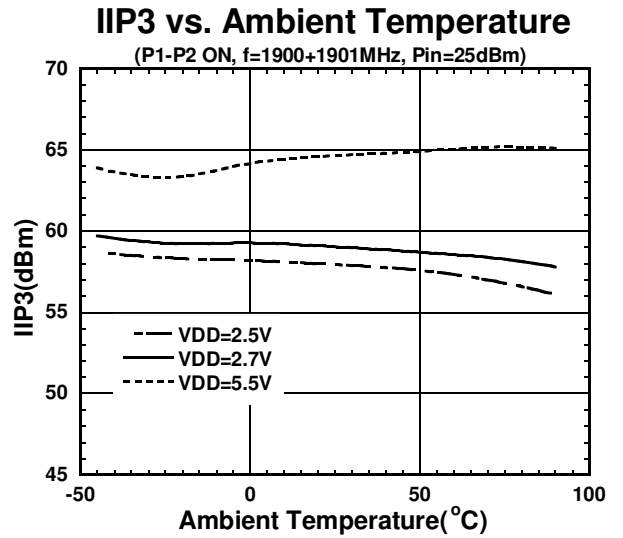
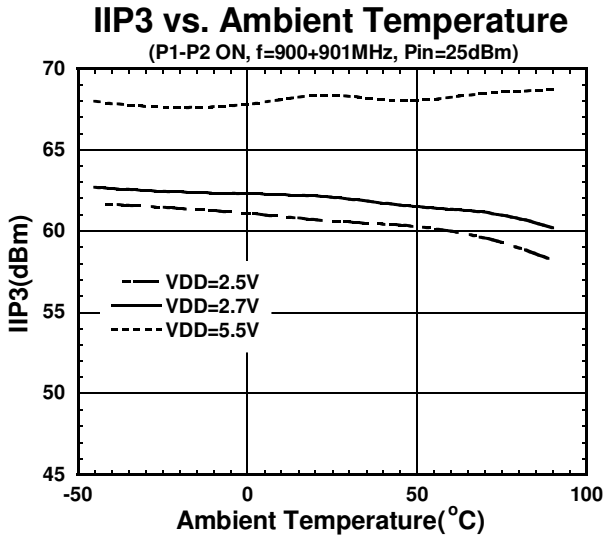

Switching Speed
(Vctl(L)=0V, Vctl(H)=2.7V)

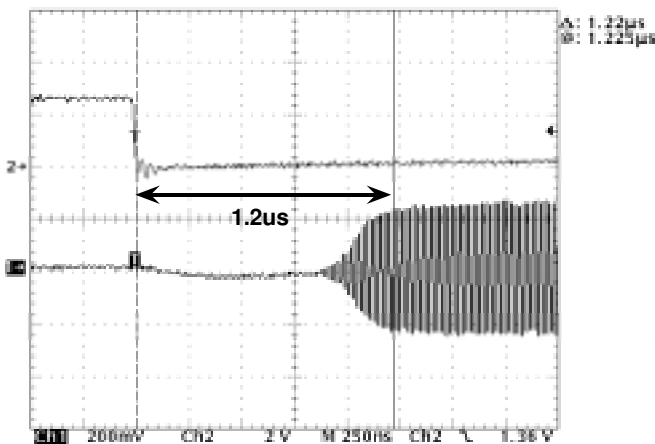

NJG1602HE3

PACKAGE OUTLINE (USB12-E3)

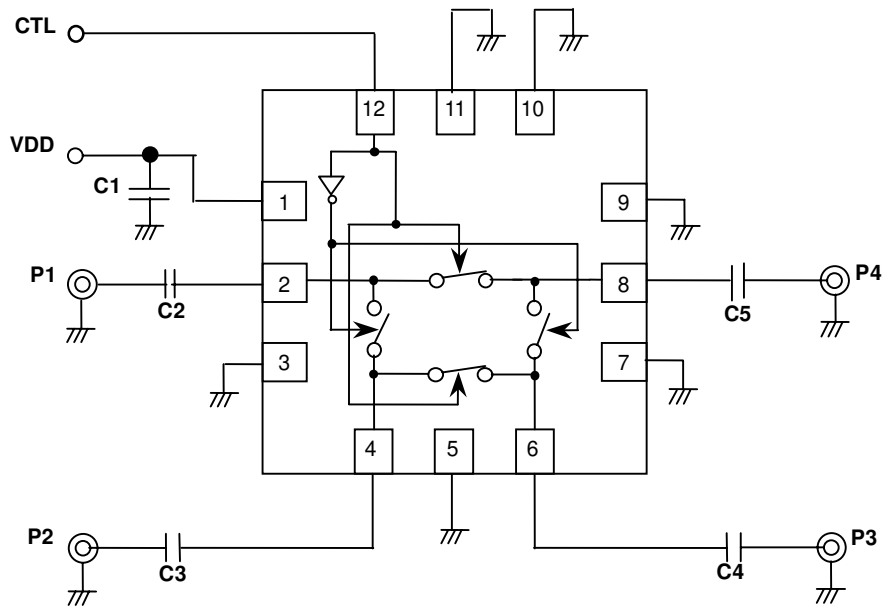

PARTS LIST

| Parts | | Notes |
|-------|--------|----------------|
| C1 | 1000pF | MURATA (GRP15) |
| C2~C5 | 56pF | MURATA (GRP15) |

RECOMMENDED PCB DESIGN

VDD CTL GND

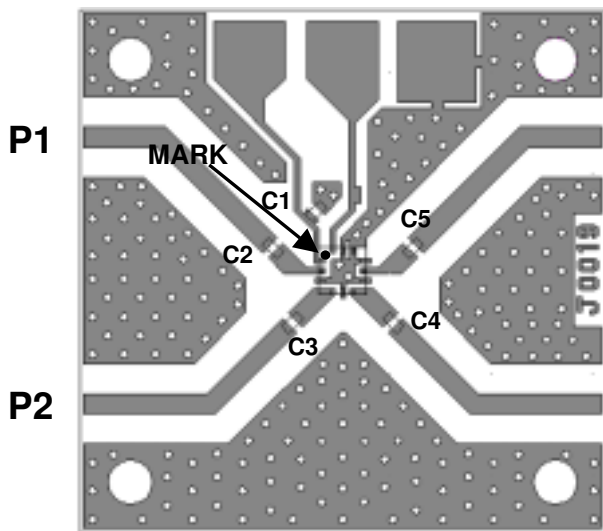

PCB SIZE=26mmX26mm
 PCB: FR-4, t=0.5mm
 Capacitor: size 1005
 Strip line Width=1.0mm ($Z_0=50\Omega$)

■Circuit losses including losses of capacitors and connectors

| Frequency | 900MHz | 1.9GHz |
|-----------|--------|--------|
| Loss(dB) | 0.20dB | 0.32dB |

MEASURING BLOCK DIAGRAM

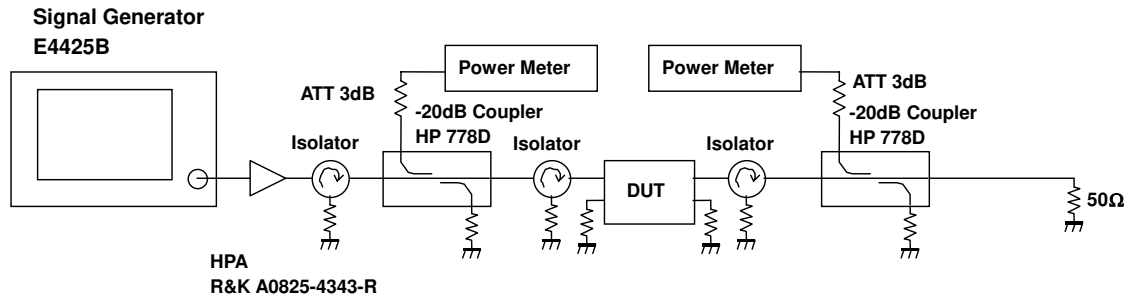

Pin-Pout Measuring Block Diagram

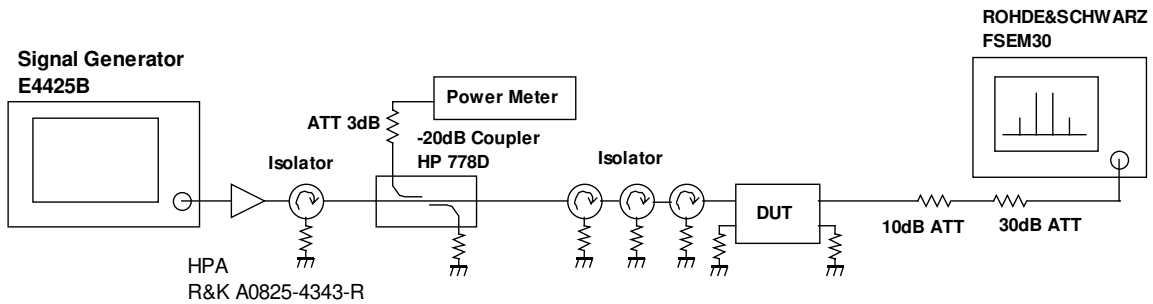

2fo, 3fo Measuring Block Diagram

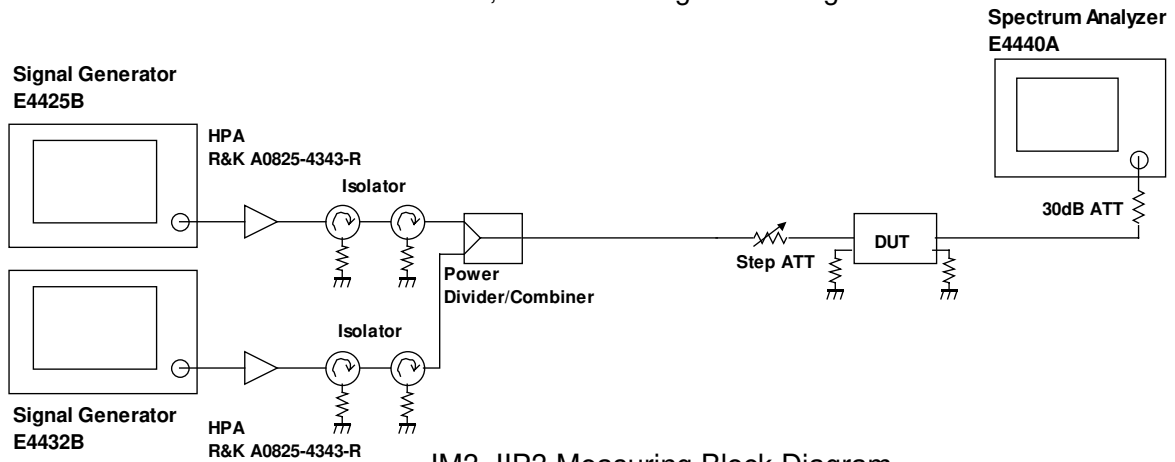

IM3, IIP3 Measuring Block Diagram

NJG1602HE3

PACKAGE OUTLINE(USB12-E3)

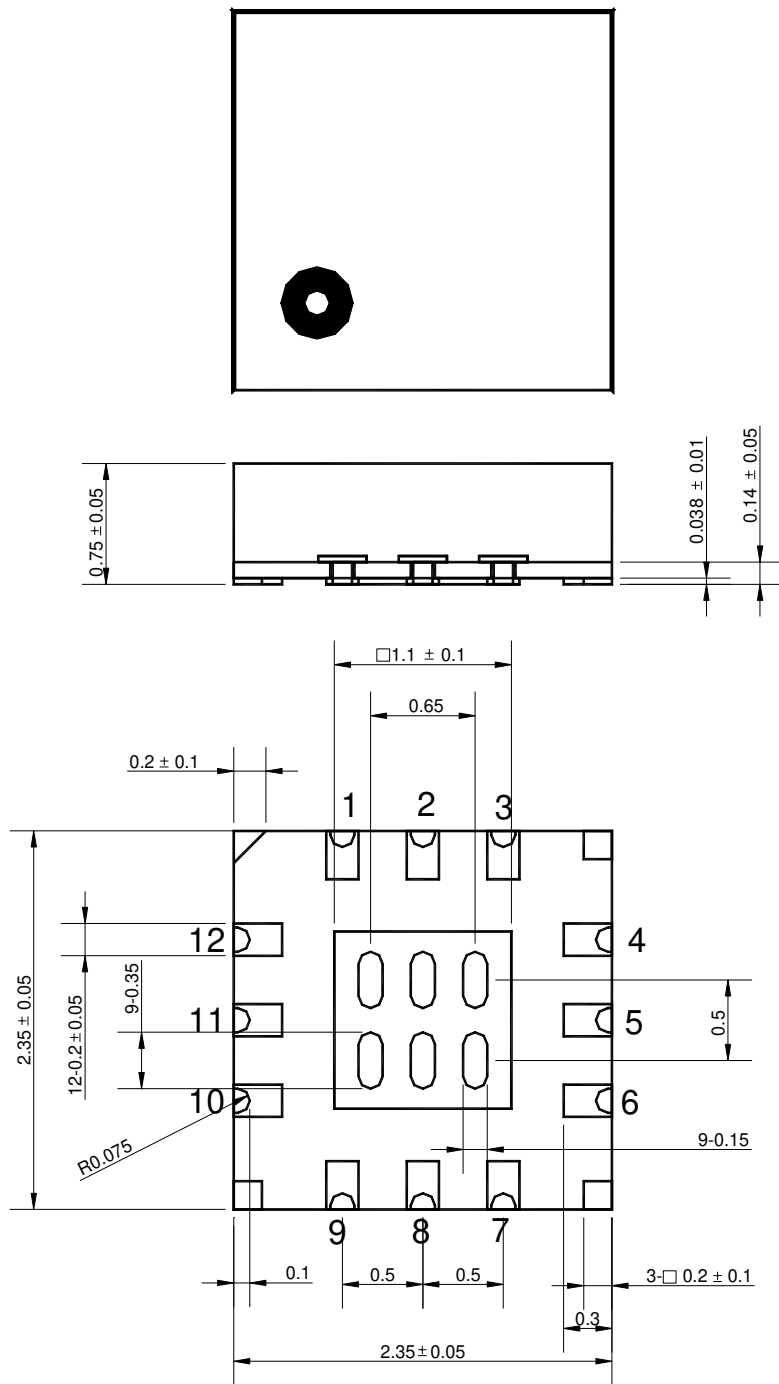

NAL TREAT :Au
 :FR5
 Molding material : Epoxy resin
 UNIT :mm
 WEIGHT :17mg

Cautions on using this product

- This product contains Gallium-Arsenide (GaAs) which is a harmful material.
- Do NOT eat or put into mouth.
 - Do NOT dispose in fire or break up this product.
 - Do NOT chemically make gas or powder with this product.
 - To waste this product, please obey the relating law of your country.

[CAUTION]

The specifications on this databook are only given for information, without any guarantee as regards either mistakes or omissions. The application circuits in this databook are described only to show representative usages of the product and not intended for the guarantee or permission of any right including the industrial rights.