

CCD SIGNAL PROCESSOR FOR DIGITAL CAMERAS

FEATURES

- **CCD Signal Processing:**
 - Correlated Double Sampling (CDS)
 - Programmable Black Level Clamping
- **Programmable Gain Amplifier (PGA)**
–6-dB to 42-dB Gain Ranging
- **12-Bit Digital Data Output:**
 - Up to 28-MHz Conversion Rate
 - No Missing Codes
- **77-dB Signal-To-Noise Ratio**
- **Portable Operation:**
 - Low Voltage: 2.7 V to 3.6 V
 - Low Power: 94 mW (Typ) at 3 V
 - Stand-By Mode: 6 mW

APPLICATIONS

- DSC, DVC, Security Camera

DESCRIPTION

The VSP2272 device is a complete mixed-signal processing IC for digital cameras providing signal conditioning and analog-to-digital conversion for the output of a charge-coupled device (CCD) array. The primary CCD channel provides correlated double sampling (CDS) to extract the video information from the pixels, –6-dB to 42-dB gain range with digital control for varying illumination conditions, and black level clamping for an accurate black level reference. Input signal clamping and offset correction of the input CDS are also performed. The stable gain control is linear in dB. Additionally, the black level is quickly recovered after gain change.

The VSP2272Y device is available in a 48-lead LQFP package and the VSP2272M device is available in a 48-lead P-VQFN package. Both devices operate from a single 3-V/3.3-V supply.

AVAILABLE OPTIONS

PRODUCT	PACKAGE	PACKAGE OUTLINE DESIGNATOR†	SPECIFIED TEMPERATURE RANGE	PACKAGE MARKING	ORDERING NUMBER‡	TRANSPORT MEDIA
VSP2272Y	48-Lead LQFP	PT	–25°C to 85°C	VSP2272Y	VSP2272Y	250-piece tray
VSP2272Y	48-Lead LQFP	PT	–25°C to 85°C	VSP2272Y	VSP2272Y/2K	Tape and reel
VSP2272M	48-Lead P-VQFN	RGN	–25°C to 85°C	VSP2272M	VSP2272M	250-piece tray
VSP2272M	48-Lead P-VQFN	RGN	–25°C to 85°C	VSP2272M	VSP2272M/2K	Tape and reel

† A detailed drawing and a dimension table are located at the end of the data sheet.

‡ Models with a slash (/) are available only in tape and reel in the quantities indicated (e.g., /2K indicates 2,000 devices per reel). Ordering 2,000 pieces of the VSP2272Y/2K device will get a single 2,000-piece tape and reel.



Please be aware that an important notice concerning availability, standard warranty, and use in critical applications of Texas Instruments semiconductor products and disclaimers thereto appears at the end of this data sheet.

PRODUCTION DATA information is current as of publication date. Products conform to specifications per the terms of Texas Instruments standard warranty. Production processing does not necessarily include testing of all parameters.

Copyright © 2001, Texas Instruments Incorporated

PACKAGING INFORMATION

Orderable Device	Status (1)	Package Type	Package Drawing	Pins	Package Qty	Eco Plan (2)	Lead finish/ Ball material (6)	MSL Peak Temp (3)	Op Temp (°C)	Device Marking (4/5)	Samples
VSP2272M/2K	LIFEBUY	VQFN	RGN	48	2000	RoHS & Green	NIPDAU	Level-1-260C-UNLIM	-25 to 85	VSP2272M	
VSP2272Y	LIFEBUY	LQFP	PT	48	250	RoHS & Green	NIPDAU	Level-1-260C-UNLIM	-25 to 85	VSP2272Y	

(1) The marketing status values are defined as follows:

ACTIVE: Product device recommended for new designs.

LIFEBUY: TI has announced that the device will be discontinued, and a lifetime-buy period is in effect.

NRND: Not recommended for new designs. Device is in production to support existing customers, but TI does not recommend using this part in a new design.

PREVIEW: Device has been announced but is not in production. Samples may or may not be available.

OBSELETE: TI has discontinued the production of the device.

(2) **RoHS:** TI defines "RoHS" to mean semiconductor products that are compliant with the current EU RoHS requirements for all 10 RoHS substances, including the requirement that RoHS substance do not exceed 0.1% by weight in homogeneous materials. Where designed to be soldered at high temperatures, "RoHS" products are suitable for use in specified lead-free processes. TI may reference these types of products as "Pb-Free".

RoHS Exempt: TI defines "RoHS Exempt" to mean products that contain lead but are compliant with EU RoHS pursuant to a specific EU RoHS exemption.

Green: TI defines "Green" to mean the content of Chlorine (Cl) and Bromine (Br) based flame retardants meet JS709B low halogen requirements of <=1000ppm threshold. Antimony trioxide based flame retardants must also meet the <=1000ppm threshold requirement.

(3) MSL, Peak Temp. - The Moisture Sensitivity Level rating according to the JEDEC industry standard classifications, and peak solder temperature.

(4) There may be additional marking, which relates to the logo, the lot trace code information, or the environmental category on the device.

(5) Multiple Device Markings will be inside parentheses. Only one Device Marking contained in parentheses and separated by a "~" will appear on a device. If a line is indented then it is a continuation of the previous line and the two combined represent the entire Device Marking for that device.

(6) Lead finish/Ball material - Orderable Devices may have multiple material finish options. Finish options are separated by a vertical ruled line. Lead finish/Ball material values may wrap to two lines if the finish value exceeds the maximum column width.

Important Information and Disclaimer:The information provided on this page represents TI's knowledge and belief as of the date that it is provided. TI bases its knowledge and belief on information provided by third parties, and makes no representation or warranty as to the accuracy of such information. Efforts are underway to better integrate information from third parties. TI has taken and continues to take reasonable steps to provide representative and accurate information but may not have conducted destructive testing or chemical analysis on incoming materials and chemicals. TI and TI suppliers consider certain information to be proprietary, and thus CAS numbers and other limited information may not be available for release.

In no event shall TI's liability arising out of such information exceed the total purchase price of the TI part(s) at issue in this document sold by TI to Customer on an annual basis.

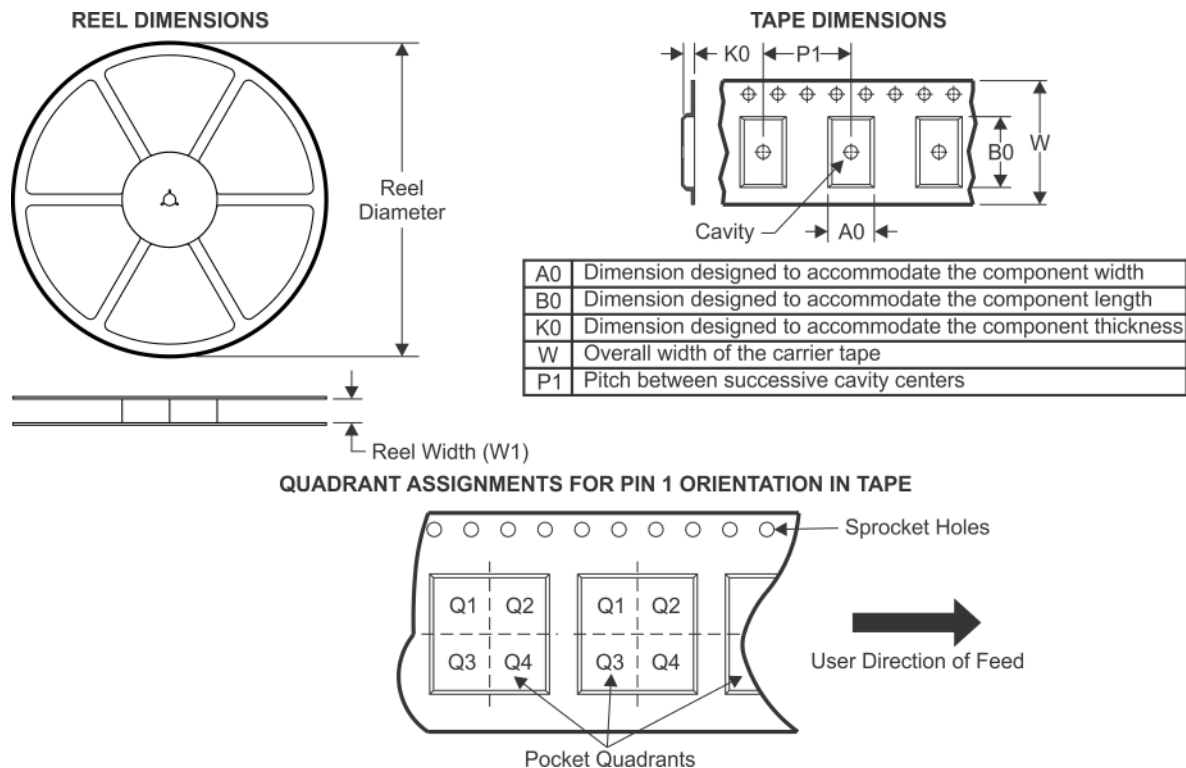
TAPE AND REEL INFORMATION

*All dimensions are nominal

Device	Package Type	Package Drawing	Pins	SPQ	Reel Diameter (mm)	Reel Width W1 (mm)	A0 (mm)	B0 (mm)	K0 (mm)	P1 (mm)	W (mm)	Pin1 Quadrant
VSP2272M/2K	VQFN	RGN	48	2000	330.0	17.4	7.4	7.4	1.3	12.0	16.0	Q1

TAPE AND REEL BOX DIMENSIONS

*All dimensions are nominal

Device	Package Type	Package Drawing	Pins	SPQ	Length (mm)	Width (mm)	Height (mm)
VSP2272M/2K	VQFN	RGN	48	2000	367.0	367.0	38.0

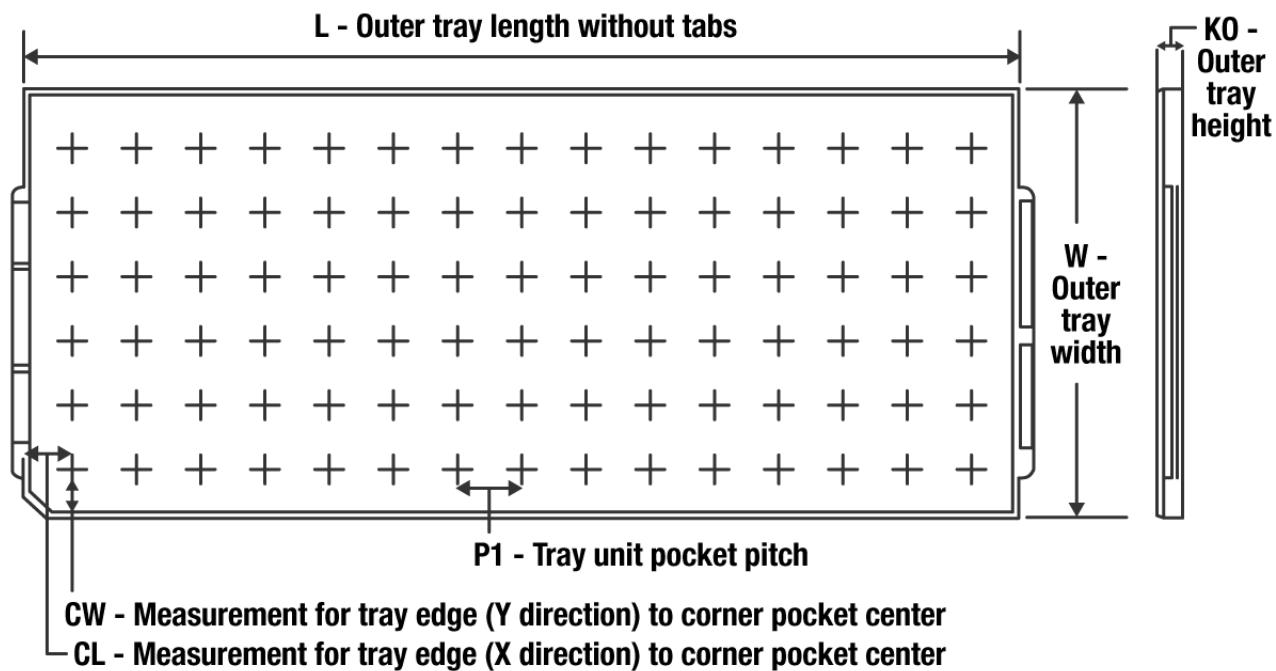
TRAY

Chamfer on Tray corner indicates Pin 1 orientation of packed units.

*All dimensions are nominal

Device	Package Name	Package Type	Pins	SPQ	Unit array matrix	Max temperature (°C)	L (mm)	W (mm)	K0 (µm)	P1 (mm)	CL (mm)	CW (mm)
VSP2272Y	PT	LQFP	48	250	10x25	150	315	135.9	7.62	12.2	11.1	11.25

RGN (S-PQFP-N48)

PLASTIC QUAD FLATPACK

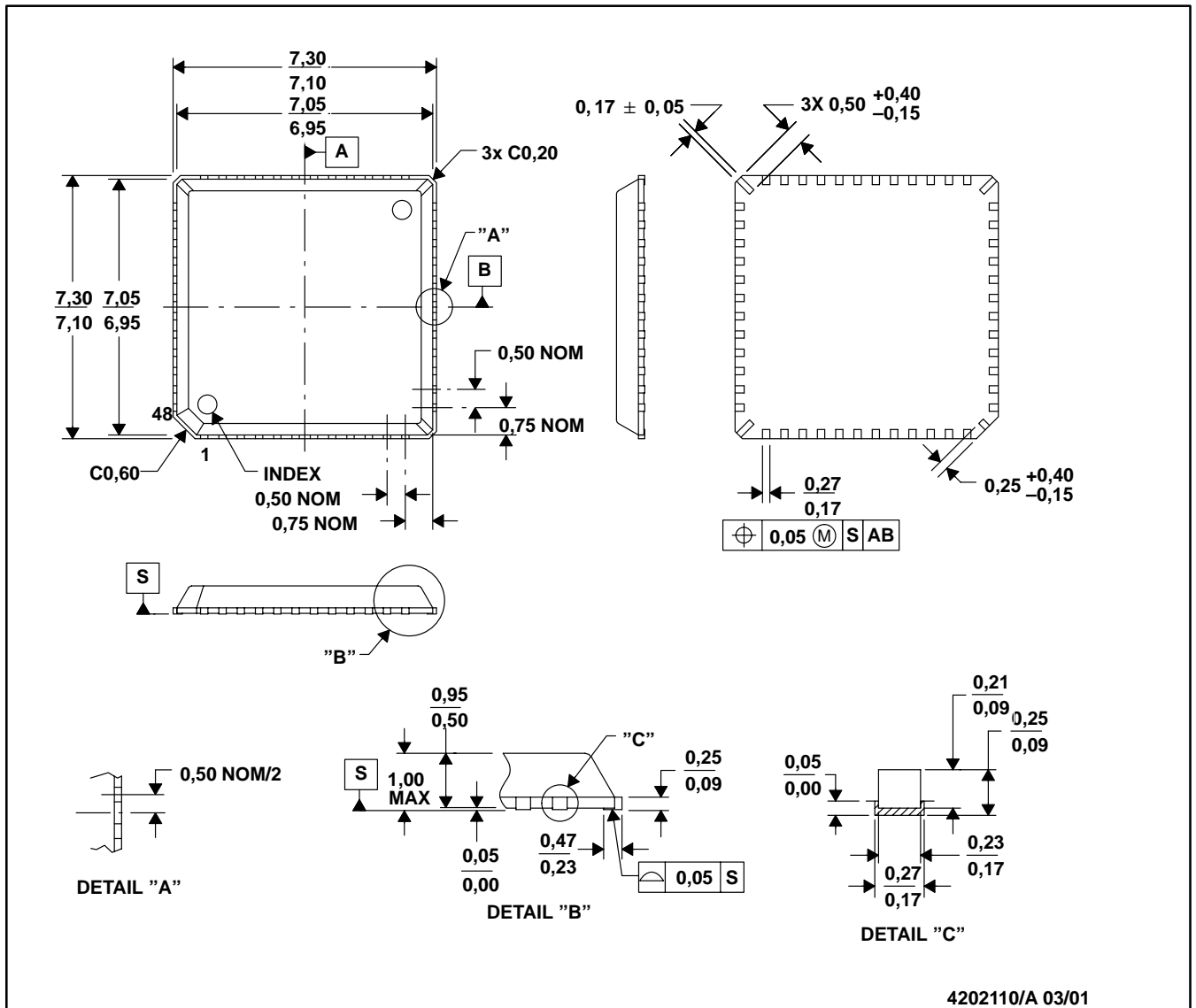

4202110/A 03/01

- NOTES: A. All linear dimensions are in millimeters.
 B. This drawing is subject to change without notice.
 C. These dimensions include package bend.

PT0048A



PACKAGE OUTLINE

LQFP - 1.6 mm max height

LOW PROFILE QUAD FLATPACK

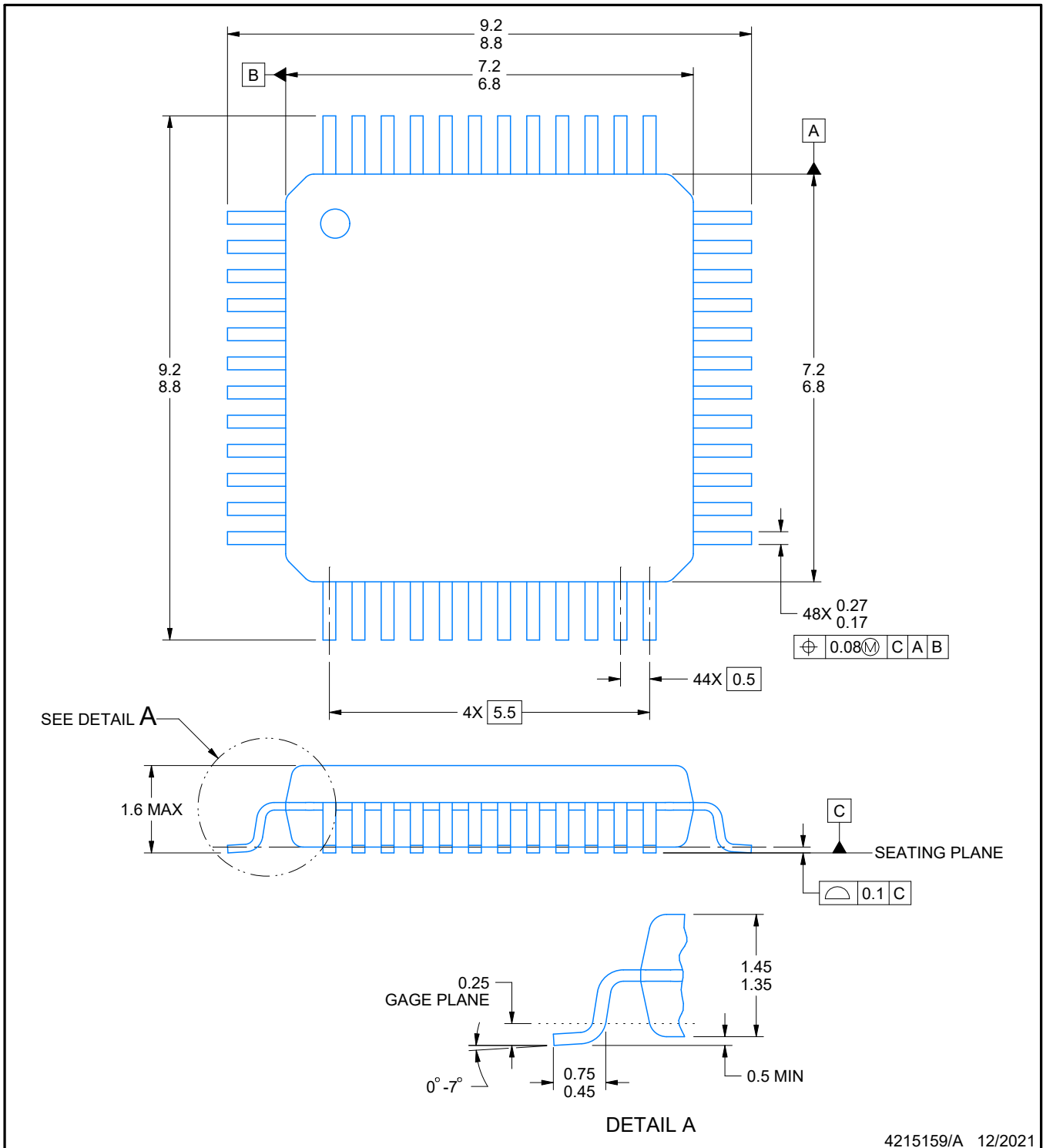

NOTES:

1. All linear dimensions are in millimeters. Any dimensions in parenthesis are for reference only. Dimensioning and tolerancing per ASME Y14.5M.
2. This drawing is subject to change without notice.
3. Reference JEDEC registration MS-026.
4. This may also be a thermally enhanced plastic package with leads connected to the die pads.

EXAMPLE BOARD LAYOUT

PT0048A

LQFP - 1.6 mm max height

LOW PROFILE QUAD FLATPACK

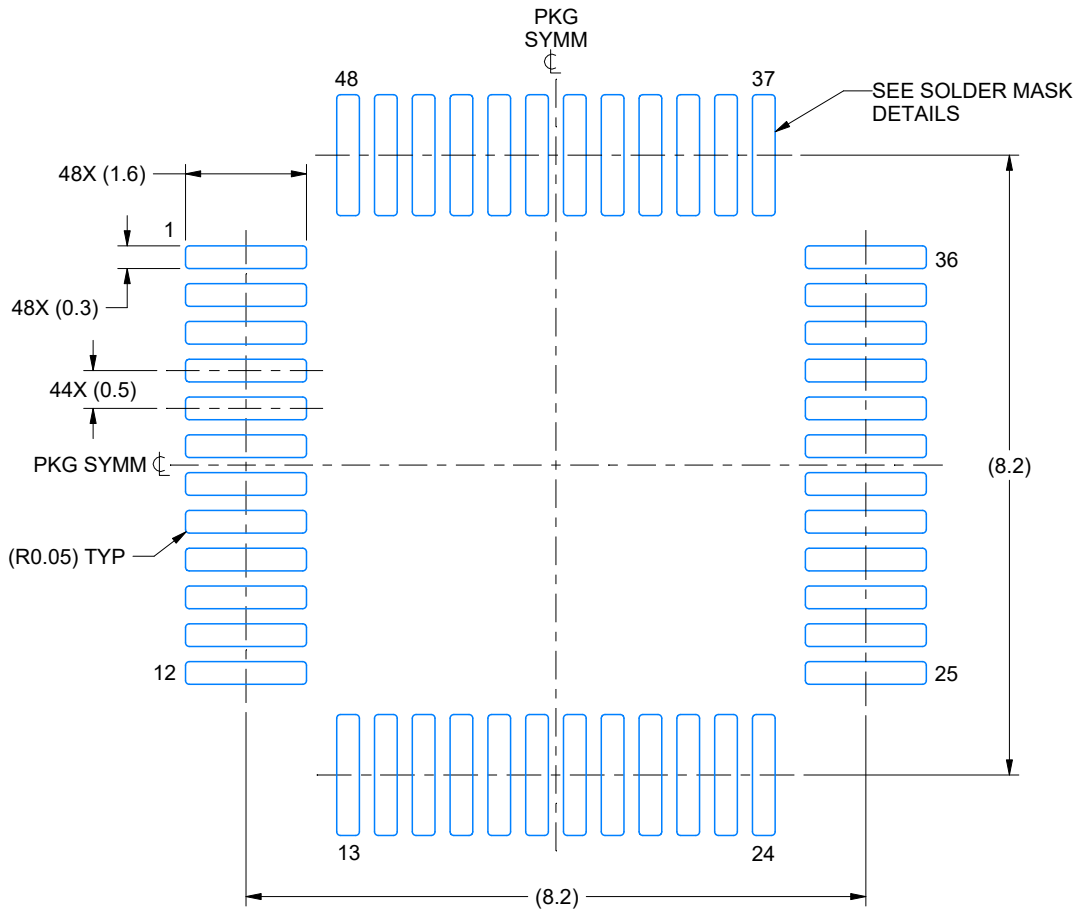

LAND PATTERN EXAMPLE
EXPOSED METAL SHOWN
SCALE 10.000

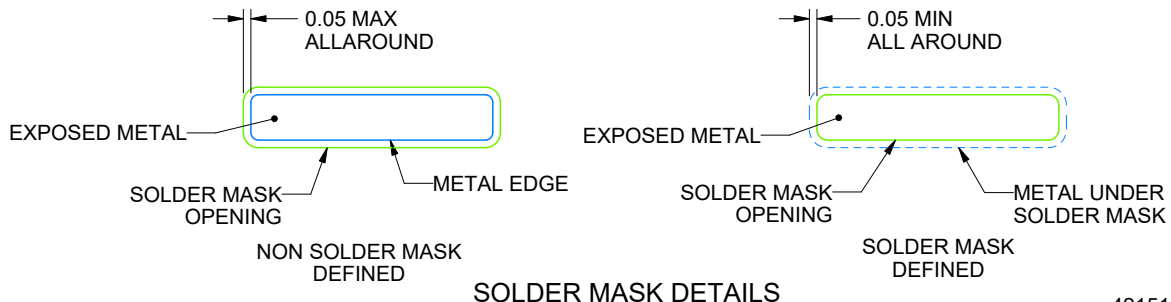

SOLDER MASK DETAILS

4215159/A 12/2021

NOTES: (continued)

5. Publication IPC-7351 may have alternate designs.
6. Solder mask tolerances between and around signal pads can vary based on board fabrication site.

EXAMPLE STENCIL DESIGN

PT0048A

LQFP - 1.6 mm max height

LOW PROFILE QUAD FLATPACK

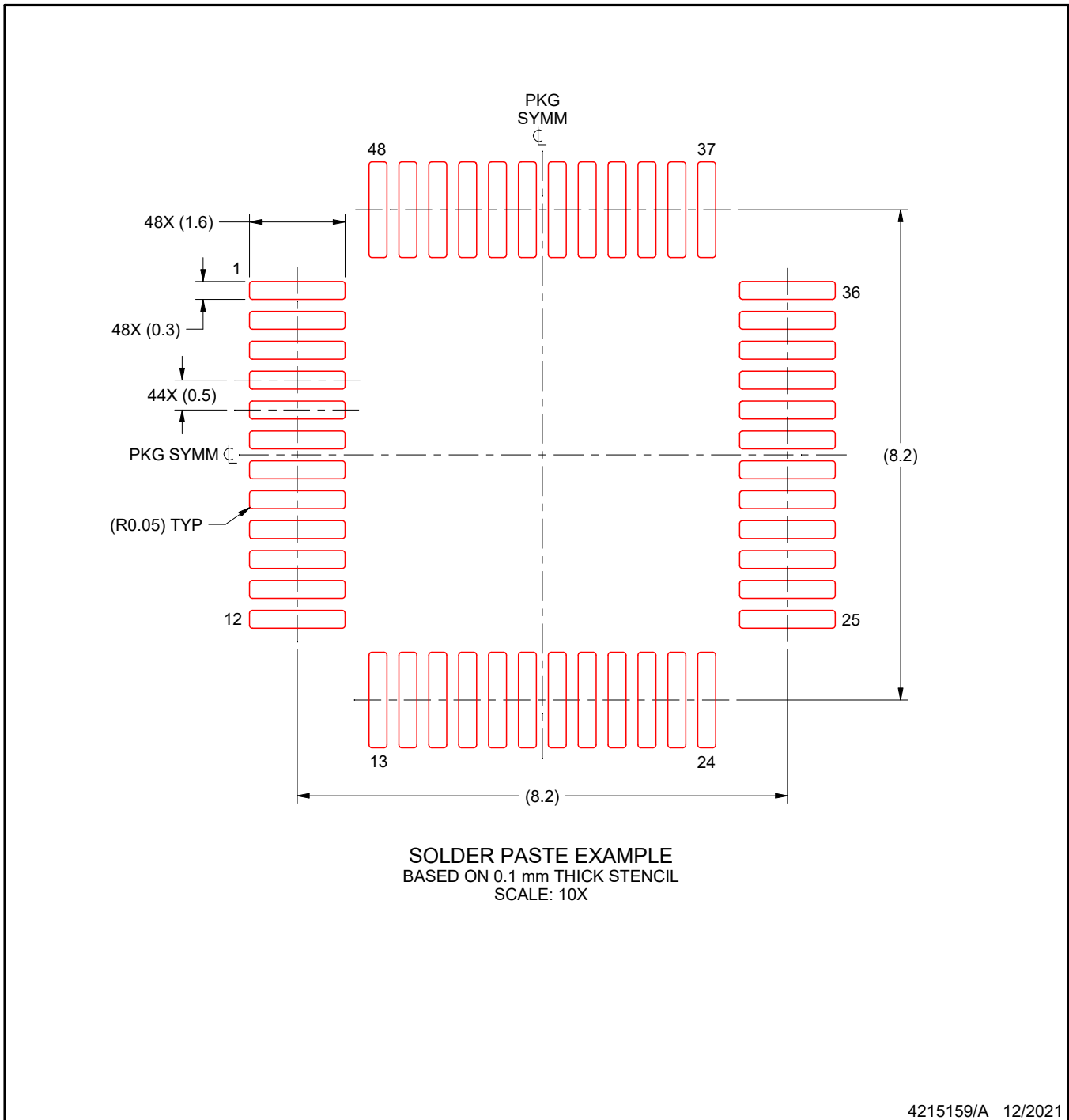

NOTES: (continued)

7. Laser cutting apertures with trapezoidal walls and rounded corners may offer better paste release. IPC-7525 may have alternate design recommendations.
8. Board assembly site may have different recommendations for stencil design.

IMPORTANT NOTICE AND DISCLAIMER

TI PROVIDES TECHNICAL AND RELIABILITY DATA (INCLUDING DATA SHEETS), DESIGN RESOURCES (INCLUDING REFERENCE DESIGNS), APPLICATION OR OTHER DESIGN ADVICE, WEB TOOLS, SAFETY INFORMATION, AND OTHER RESOURCES "AS IS" AND WITH ALL FAULTS, AND DISCLAIMS ALL WARRANTIES, EXPRESS AND IMPLIED, INCLUDING WITHOUT LIMITATION ANY IMPLIED WARRANTIES OF MERCHANTABILITY, FITNESS FOR A PARTICULAR PURPOSE OR NON-INFRINGEMENT OF THIRD PARTY INTELLECTUAL PROPERTY RIGHTS.

These resources are intended for skilled developers designing with TI products. You are solely responsible for (1) selecting the appropriate TI products for your application, (2) designing, validating and testing your application, and (3) ensuring your application meets applicable standards, and any other safety, security, regulatory or other requirements.

These resources are subject to change without notice. TI grants you permission to use these resources only for development of an application that uses the TI products described in the resource. Other reproduction and display of these resources is prohibited. No license is granted to any other TI intellectual property right or to any third party intellectual property right. TI disclaims responsibility for, and you will fully indemnify TI and its representatives against, any claims, damages, costs, losses, and liabilities arising out of your use of these resources.

TI's products are provided subject to [TI's Terms of Sale](#) or other applicable terms available either on [ti.com](https://www.ti.com) or provided in conjunction with such TI products. TI's provision of these resources does not expand or otherwise alter TI's applicable warranties or warranty disclaimers for TI products.

TI objects to and rejects any additional or different terms you may have proposed.

Mailing Address: Texas Instruments, Post Office Box 655303, Dallas, Texas 75265
Copyright © 2023, Texas Instruments Incorporated