

ON Semiconductor

Is Now

onsemi™

To learn more about onsemi™, please visit our website at
www.onsemi.com

onsemi and **onsemi** and other names, marks, and brands are registered and/or common law trademarks of Semiconductor Components Industries, LLC dba "**onsemi**" or its affiliates and/or subsidiaries in the United States and/or other countries. **onsemi** owns the rights to a number of patents, trademarks, copyrights, trade secrets, and other intellectual property. A listing of **onsemi** product/patent coverage may be accessed at www.onsemi.com/site/pdf/Patent-Marking.pdf. **onsemi** reserves the right to make changes at any time to any products or information herein, without notice. The information herein is provided "as-is" and **onsemi** makes no warranty, representation or guarantee regarding the accuracy of the information, product features, availability, functionality, or suitability of its products for any particular purpose, nor does **onsemi** assume any liability arising out of the application or use of any product or circuit, and specifically disclaims any and all liability, including without limitation special, consequential or incidental damages. Buyer is responsible for its products and applications using **onsemi** products, including compliance with all laws, regulations and safety requirements or standards, regardless of any support or applications information provided by **onsemi**. "Typical" parameters which may be provided in **onsemi** data sheets and/or specifications can and do vary in different applications and actual performance may vary over time. All operating parameters, including "Typicals" must be validated for each customer application by customer's technical experts. **onsemi** does not convey any license under any of its intellectual property rights nor the rights of others. **onsemi** products are not designed, intended, or authorized for use as a critical component in life support systems or any FDA Class 3 medical devices or medical devices with a same or similar classification in a foreign jurisdiction or any devices intended for implantation in the human body. Should Buyer purchase or use **onsemi** products for any such unintended or unauthorized application, Buyer shall indemnify and hold **onsemi** and its officers, employees, subsidiaries, affiliates, and distributors harmless against all claims, costs, damages, and expenses, and reasonable attorney fees arising out of, directly or indirectly, any claim of personal injury or death associated with such unintended or unauthorized use, even if such claim alleges that **onsemi** was negligent regarding the design or manufacture of the part. **onsemi** is an Equal Opportunity/Affirmative Action Employer. This literature is subject to all applicable copyright laws and is not for resale in any manner. Other names and brands may be claimed as the property of others.

MOSFET – Power, N-Channel, SUPERFET III, FRFET

650 V, 50 mΩ, 58 A

NVHL050N65S3F

Description

SUPERFET III MOSFET is ON Semiconductor’s brand–new high voltage super–junction (SJ) MOSFET family that is utilizing charge balance technology for outstanding low on-resistance and lower gate charge performance. This advanced technology is tailored to minimize conduction loss, provide superior switching performance, and withstand extreme dv/dt rate.

Consequently, SUPERFET III MOSFET is very suitable for the various power system for miniaturization and higher efficiency.

SUPERFET III FRFET MOSFET’s optimized reverse recovery performance of body diode can remove additional component and improve system reliability.

Features

- 700 V @ $T_J = 150^\circ\text{C}$
- Typ. $R_{DS(on)} = 42\text{ m}\Omega$
- Ultra Low Gate Charge (Typ. $Q_g = 121\text{ nC}$)
- Low Effective Output Capacitance (Typ. $C_{oss(eff.)} = 1119\text{ pF}$)
- 100% Avalanche Tested
- AEC–Q101 Qualified and PPAP Capable
- These Devices are Pb–Free, Halogen Free/BFR Free and are RoHS Compliant

Applications

- Automotive On Board Charger HEV–EV
- Automotive DC/DC Converter HEV–EV



ON Semiconductor®

www.onsemi.com

V_{DSS}	$R_{DS(on)}\text{ MAX}$	$I_D\text{ MAX}$
650 V	50 mΩ	58 A

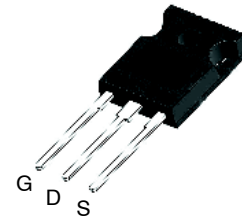
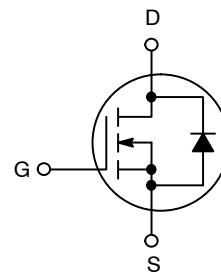

**TO–247 long leads
CASE 340CX**

MARKING DIAGRAM

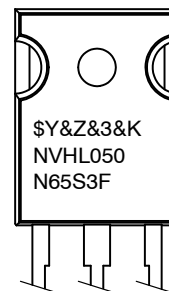

\$Y = ON Semiconductor Logo
 &Z = Assembly Plant Code
 &3 = Date Code (Year & Week)
 &K = Lot
 NVHL050N65S3F = Specific Device Code

ORDERING INFORMATION

See detailed ordering and shipping information on page 2 of this data sheet.

NVHL050N65S3F

ABSOLUTE MAXIMUM RATINGS (T_C = 25°C, Unless otherwise noted)

Symbol	Parameter	Value	Unit
V _{DSS}	Drain to Source Voltage	650	V
V _{GSS}	Gate to Source Voltage	- DC	±30
		- AC (f > 1 Hz)	±30
I _D	Drain Current	- Continuous (T _C = 25°C)	58
		- Continuous (T _C = 100°C)	36
I _{DM}	Drain Current	- Pulsed (Note 1)	145
E _{AS}	Single Pulsed Avalanche Energy (Note 2)	830	mJ
I _{AS}	Avalanche Current (Note 2)	7.5	A
E _{AR}	Repetitive Avalanche Energy (Note 1)	4.03	mJ
dv/dt	MOSFET dv/dt	100	V/ns
	Peak Diode Recovery dv/dt (Note 3)	50	
P _D	Power Dissipation	(T _C = 25°C)	403
		- Derate Above 25°C	3.23
T _J , T _{STG}	Operating and Storage Temperature Range	-55 to +150	°C
T _L	Maximum Lead Temperature for Soldering, 1/8" from Case for 5 seconds	300	°C

Stresses exceeding those listed in the Maximum Ratings table may damage the device. If any of these limits are exceeded, device functionality should not be assumed, damage may occur and reliability may be affected.

1. Repetitive rating: pulse-width limited by maximum junction temperature.
2. I_{AS} = 7.5 A, R_G = 25 Ω, starting T_J = 25°C.
3. I_{SD} ≤ 29 A, di/dt ≤ 200 A/μs, V_{DD} ≤ 400 V, starting T_J = 25°C.

THERMAL CHARACTERISTICS

Symbol	Parameter	Value	Unit
R _{θJC}	Thermal Resistance, Junction to Case, Max.	0.31	°C/W
R _{θJA}	Thermal Resistance, Junction to Ambient, Max.	40	

PACKAGE MARKING AND ORDERING INFORMATION

Part Number	Top Marking	Package	Packing Method	Reel Size	Tape Width	Quantity
NVHL050N65S3F	NVHL050N65S3F	TO-247	Tube	N/A	N/A	30 Units

NVHL050N65S3F

ELECTRICAL CHARACTERISTICS (T_C = 25°C unless otherwise noted)

Parameter	Symbol	Test Conditions	Min	Typ	Max	Unit
-----------	--------	-----------------	-----	-----	-----	------

OFF CHARACTERISTICS

Drain-to-Source Breakdown Voltage	BV _{DSS}	V _{GS} = 0 V, I _D = 1 mA, T _J = 25°C	650			V
Drain-to-Source Breakdown Voltage	BV _{DSS}	V _{GS} = 0 V, I _D = 1 mA, T _J = 150°C	700			V
Breakdown Voltage Temperature Coefficient	$\frac{\Delta BV_{DSS}}{\Delta T_J}$	I _D = 10 mA, Referenced to 25°C		640		mV/°C
Zero Gate Voltage Drain Current	I _{DSS}	V _{GS} = 0 V, V _{DS} = 650 V			10	μA
		V _{DS} = 520 V, T _C = 125°C		19		
Gate-to-Body Leakage Current	I _{GSS}	V _{GS} = ±30 V, V _{DS} = 0 V			±100	nA

ON CHARACTERISTICS

Gate Threshold Voltage	V _{GS(th)}	V _{GS} = V _{DS} , I _D = 1.7 mA	3.0		5.0	V
Threshold Temperature Coefficient	$\frac{\Delta V_{GS(th)}}{\Delta T_J}$	V _{GS} = V _{DS} , I _D = 1.7 mA		-8		mV/°C
Static Drain-to-Source On Resistance	R _{DS(on)}	V _{GS} = 10 V, I _D = 29 A		42	50	mΩ
Forward Transconductance	g _{FS}	V _{DS} = 20 V, I _D = 29 A		32.8		S

DYNAMIC CHARACTERISTICS

Input Capacitance	C _{iss}	V _{GS} = 0 V, V _{DS} = 400 V, f = 1 MHz		5404		pF
Output Capacitance	C _{oss}			110		
Reverse Transfer Capacitance	C _{rss}			13		
Effective Output Capacitance	C _{oss(eff.)}	V _{DS} = 0 V to 400 V, V _{GS} = 0 V		1119		pF
Energy Related Output Capacitance	C _{oss(er.)}	V _{DS} = 0 V to 400 V, V _{GS} = 0 V		198		pF
Total Gate Charge at 10 V	Q _{G(TOT)}	V _{GS} = 10 V, V _{DS} = 400 V, I _D = 29 A (Note 4)		123		nC
Threshold Gate Charge	Q _{G(TH)}			22.9		
Gate-to-Source Gate Charge	Q _{GS}			39.5		
Gate-to-Drain "Miller" Charge	Q _{GD}			51.4		
Equivalent Series Resistance	ESR	f = 1 MHz		1.7		Ω

SWITCHING CHARACTERISTICS

Turn-On Delay Time	t _{d(on)}	V _{GS} = 10 V, V _{DD} = 400 V, I _D = 29 A, R _g = 2.2 Ω (Note 4)		38		ns
Turn-On Rise Time	t _r			47		ns
Turn-Off Delay Time	t _{d(off)}			87		ns
Turn-Off Fall Time	t _f			6		ns

SOURCE-DRAIN DIODE CHARACTERISTICS

Maximum Continuous Source-to-Drain Diode Forward Current	I _S	V _{GS} = 0 V			58	A
Maximum Pulsed Source-to-Drain Diode Forward Current	I _{SM}	V _{GS} = 0 V			145	A
Source-to-Drain Diode Forward Voltage	V _{SD}	V _{GS} = 0 V, I _{SD} = 29 A			1.3	V
Reverse Recovery Time	t _{rr}	V _{GS} = 0 V, dI _F /dt = 100 A/μs, I _{SD} = 29 A		133		ns
Charge Time	t _a			106		
Discharge Time	t _b			27		
Reverse Recovery Charge	Q _{rr}			603		

Product parametric performance is indicated in the Electrical Characteristics for the listed test conditions, unless otherwise noted. Product performance may not be indicated by the Electrical Characteristics if operated under different conditions.

4. Essentially independent of operating temperature typical characteristics.

TYPICAL CHARACTERISTICS

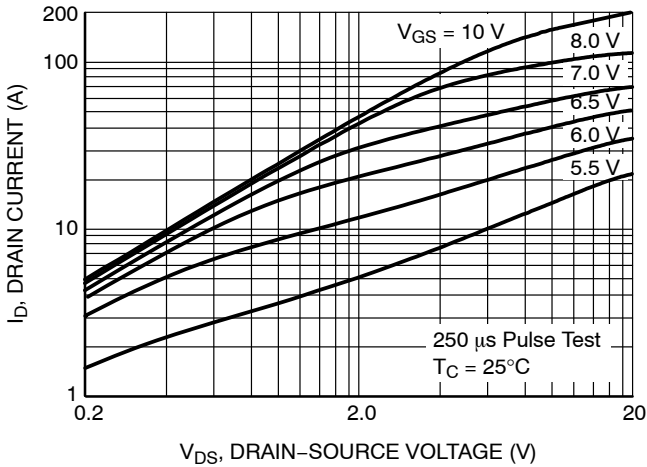

Figure 1. On-Region Characteristics

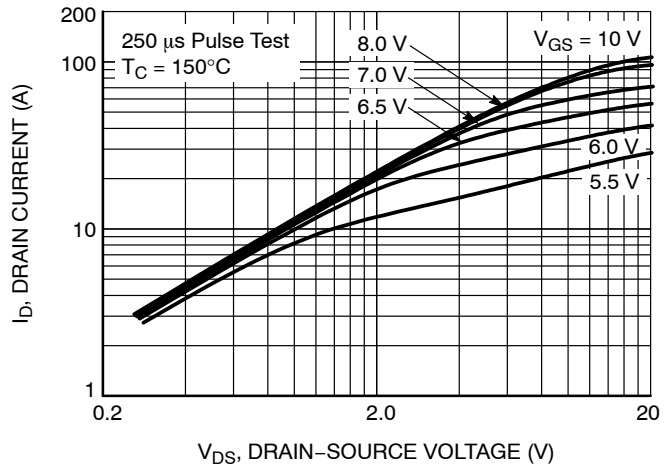

Figure 2. On-Region Characteristics

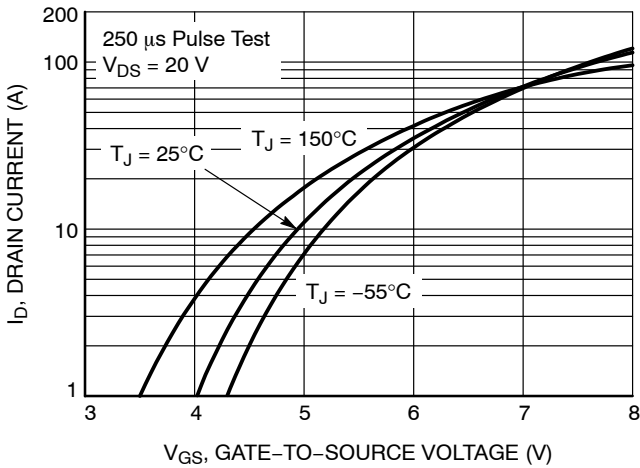

Figure 3. Transfer Characteristics

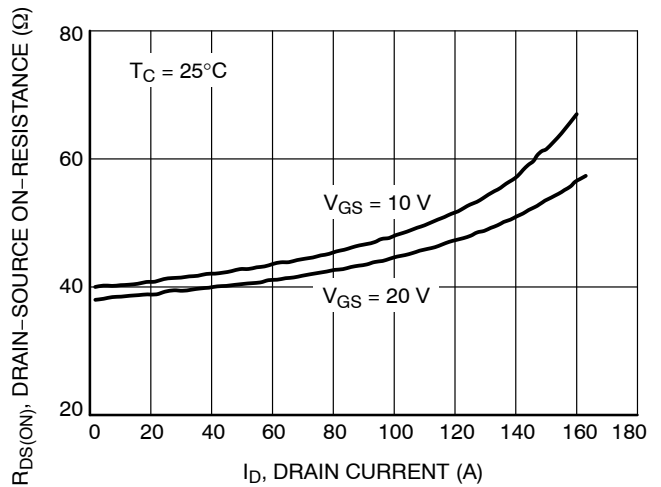

Figure 4. On-Resistance Variation vs. Drain Current and Gate Voltage

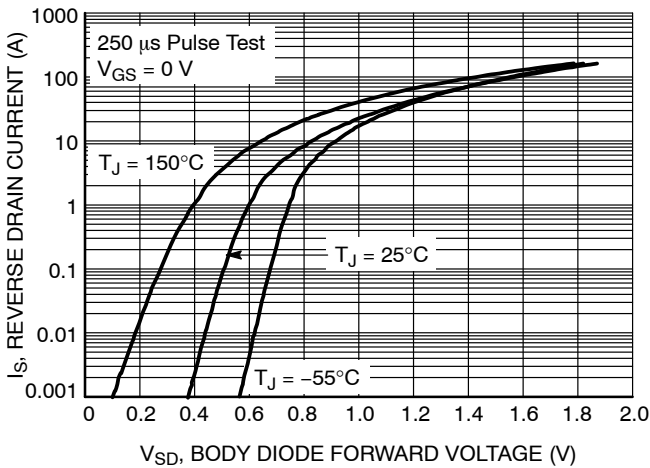

Figure 5. Body Diode Forward Voltage Variation vs. Source Current and Temperature

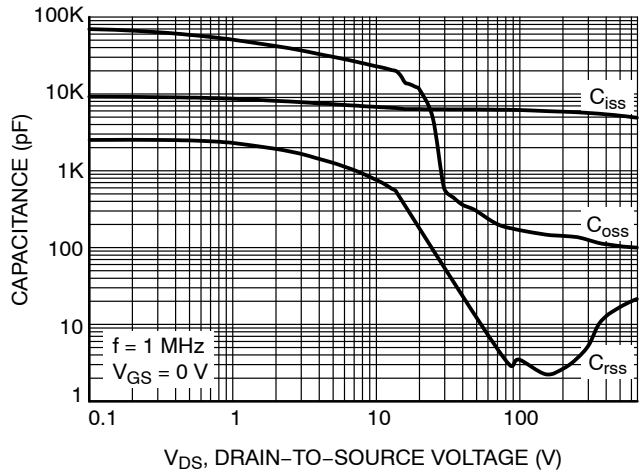

Figure 6. Capacitance Characteristics

NVHL050N65S3F

TYPICAL CHARACTERISTICS

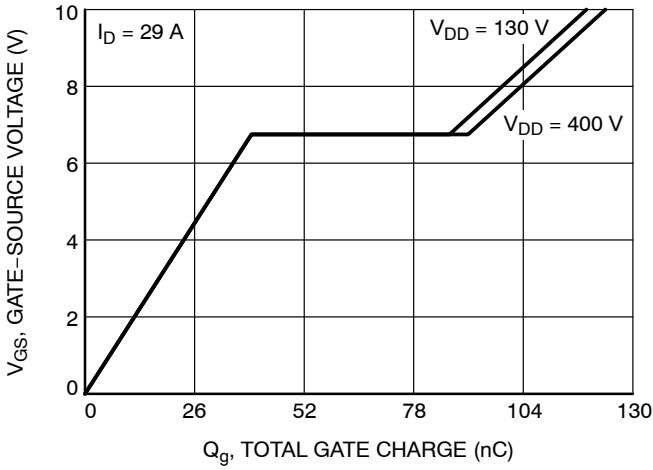

Figure 7. Gate Charge Characteristics

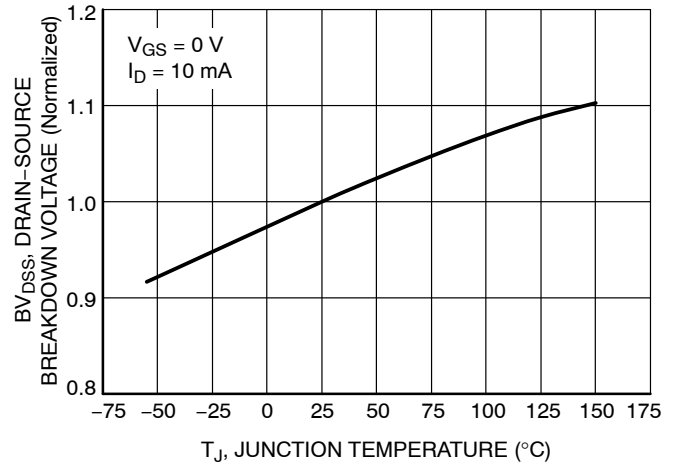

Figure 8. Breakdown Voltage Variation vs. Temperature

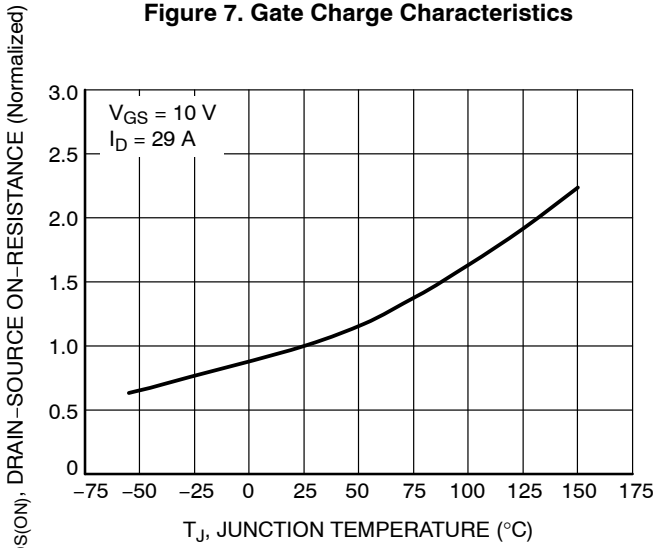

Figure 9. On-Resistance Variation vs. Temperature

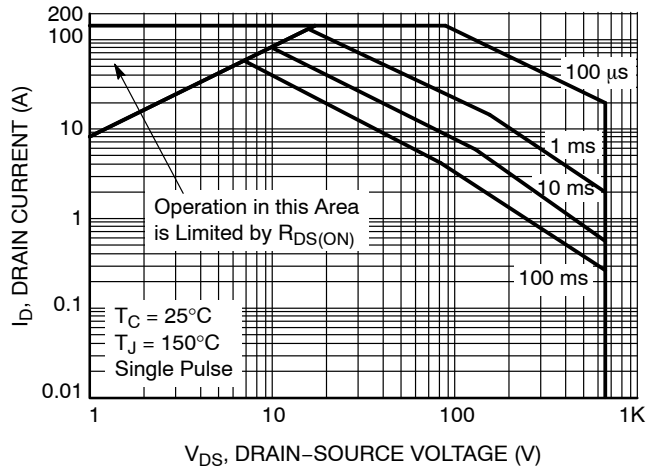

Figure 10. Maximum Safe Operating Area

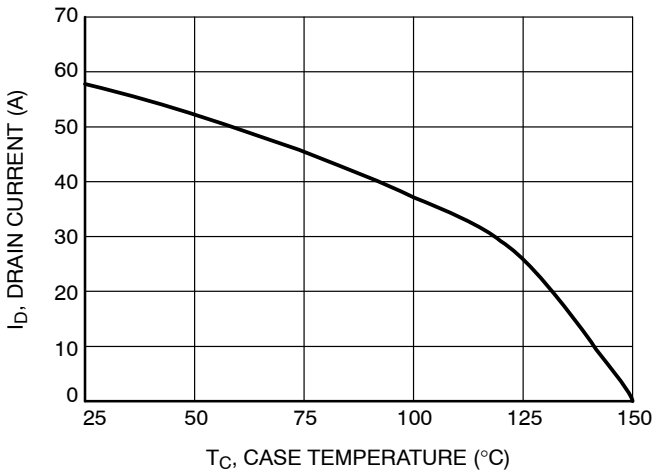

Figure 11. Maximum Drain Current vs. Case Temperature

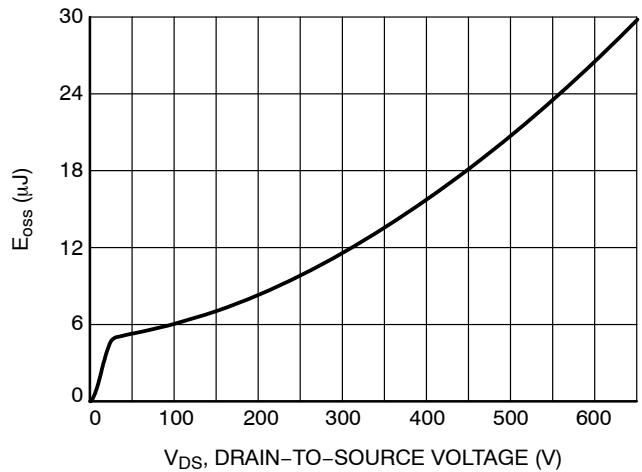

Figure 12. E_OSS vs. Drain-to-Source Voltage

NVHL050N65S3F

TYPICAL CHARACTERISTICS

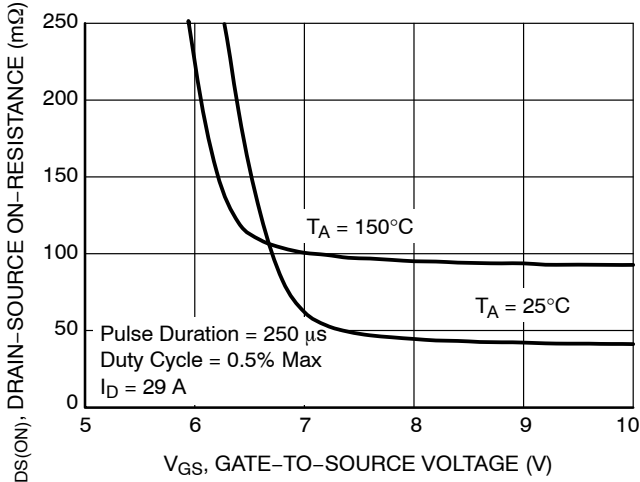

Figure 13. $R_{DS(ON)}$ vs. Gate Voltage

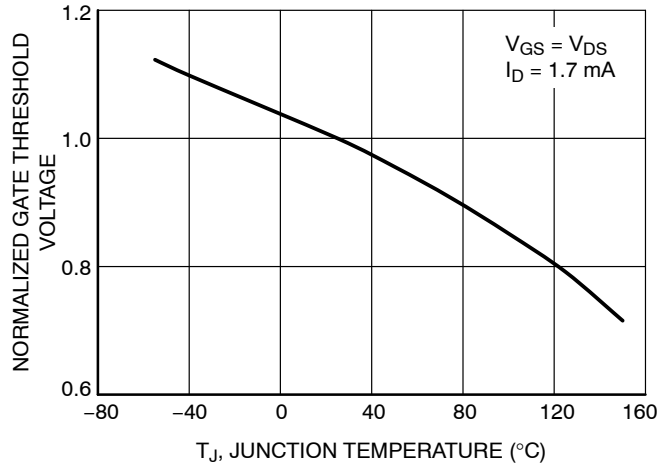

Figure 14. Normalized Gate Threshold Voltage vs. Temperature

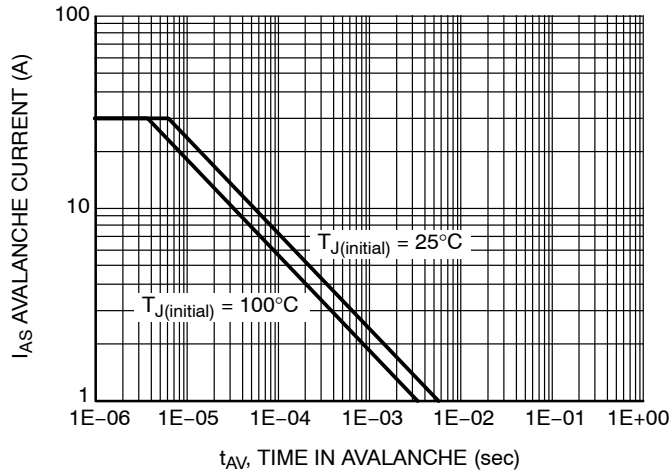

Figure 15. Unclamped Inductive Switching Capability

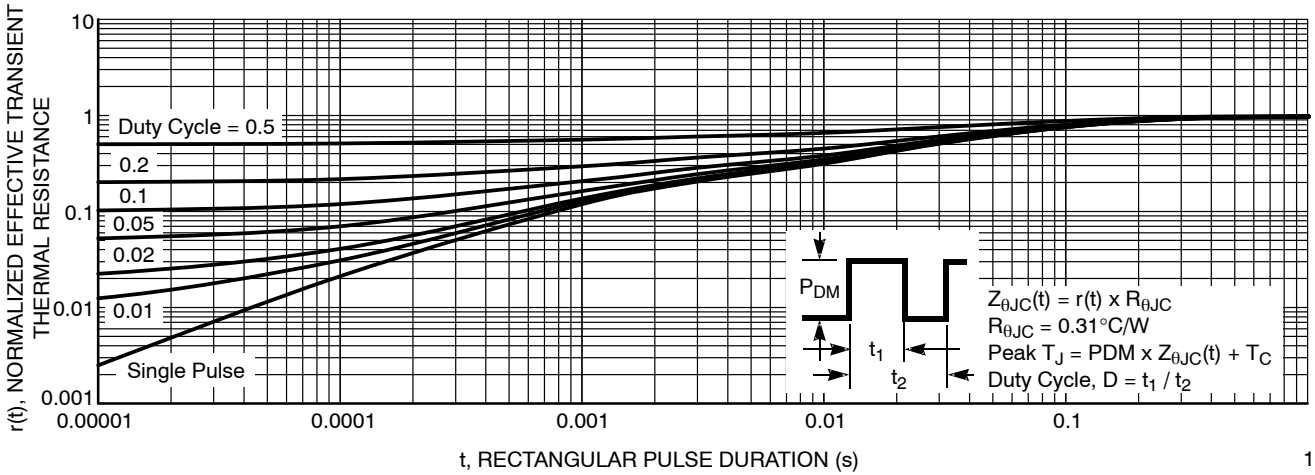

Figure 16. Transient Thermal Response Curve

SUPERFET and FRFET are registered trademarks of Semiconductor Components Industries, LLC.

NVHL050N65S3F

PACKAGE DIMENSIONS

TO-247-3LD
CASE 340CX
ISSUE O

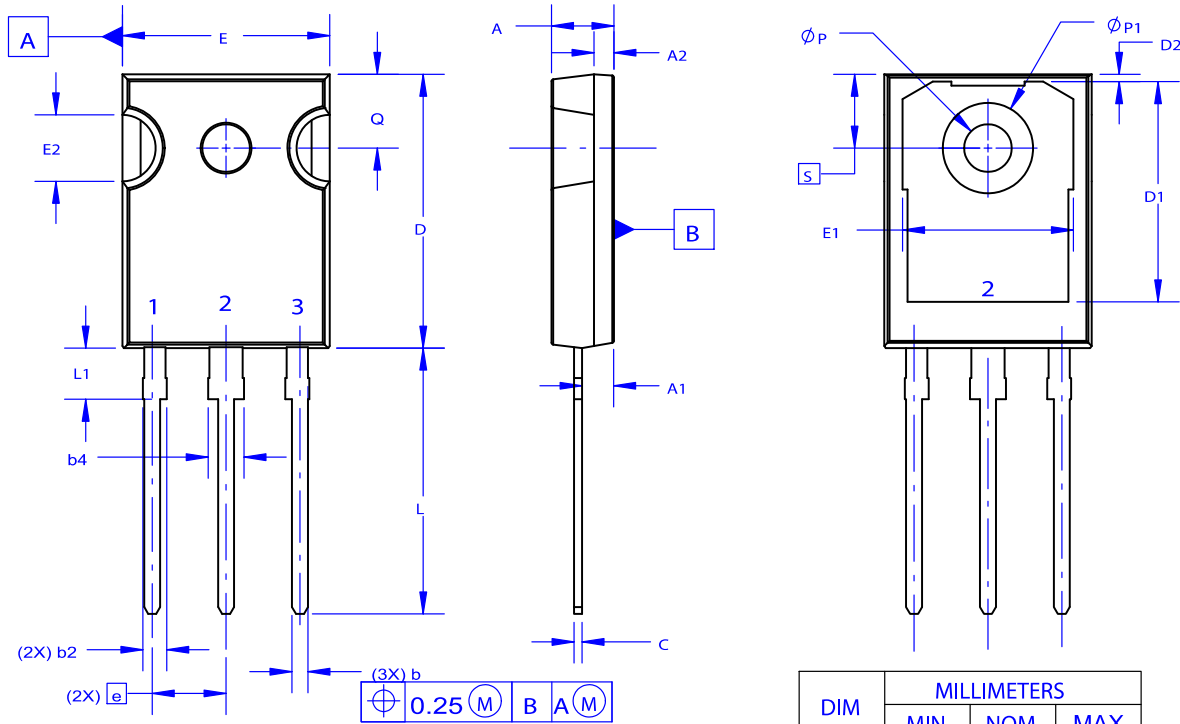

NOTES: UNLESS OTHERWISE SPECIFIED.

- A. DIMENSIONS ARE EXCLUSIVE OF BURRS, MOLD FLASH, AND TIE BAR EXTRUSIONS.
- B. ALL DIMENSIONS ARE IN MILLIMETERS.
- C. DRAWING CONFORMS TO ASME Y14.5 - 2009.
- D. DIMENSION A1 TO BE MEASURED IN THE REGION DEFINED BY L1.
- E. LEAD FINISH IS UNCONTROLLED IN THE REGION DEFINED BY L1.

ON Semiconductor and  are trademarks of Semiconductor Components Industries, LLC dba ON Semiconductor or its subsidiaries in the United States and/or other countries. ON Semiconductor owns the rights to a number of patents, trademarks, copyrights, trade secrets, and other intellectual property. A listing of ON Semiconductor's product/patent coverage may be accessed at www.onsemi.com/site/pdf/Patent-Marking.pdf. ON Semiconductor reserves the right to make changes without further notice to any products herein. ON Semiconductor makes no warranty, representation or guarantee regarding the suitability of its products for any particular purpose, nor does ON Semiconductor assume any liability arising out of the application or use of any product or circuit, and specifically disclaims any and all liability, including without limitation special, consequential or incidental damages. Buyer is responsible for its products and applications using ON Semiconductor products, including compliance with all laws, regulations and safety requirements or standards, regardless of any support or applications information provided by ON Semiconductor. "Typical" parameters which may be provided in ON Semiconductor data sheets and/or specifications can and do vary in different applications and actual performance may vary over time. All operating parameters, including "Typicals" must be validated for each customer application by customer's technical experts. ON Semiconductor does not convey any license under its patent rights nor the rights of others. ON Semiconductor products are not designed, intended, or authorized for use as a critical component in life support systems or any FDA Class 3 medical devices or medical devices with a same or similar classification in a foreign jurisdiction or any devices intended for implantation in the human body. Should Buyer purchase or use ON Semiconductor products for any such unintended or unauthorized application, Buyer shall indemnify and hold ON Semiconductor and its officers, employees, subsidiaries, affiliates, and distributors harmless against all claims, costs, damages, and expenses, and reasonable attorney fees arising out of, directly or indirectly, any claim of personal injury or death associated with such unintended or unauthorized use, even if such claim alleges that ON Semiconductor was negligent regarding the design or manufacture of the part. ON Semiconductor is an Equal Opportunity/Affirmative Action Employer. This literature is subject to all applicable copyright laws and is not for resale in any manner.

PUBLICATION ORDERING INFORMATION

LITERATURE FULFILLMENT:

Email Requests to: orderlit@onsemi.com

ON Semiconductor Website: www.onsemi.com

TECHNICAL SUPPORT

North American Technical Support:
Voice Mail: 1 800-282-9855 Toll Free USA/Canada
Phone: 011 421 33 790 2910

Europe, Middle East and Africa Technical Support:
Phone: 00421 33 790 2910

For additional information, please contact your local Sales Representative