

**Full bridge  
High speed Trench + Field Stop IGBT4  
Power Module**

**$V_{CES} = 1200V$   
 $I_C = 75A @ T_c = 80^\circ C$**

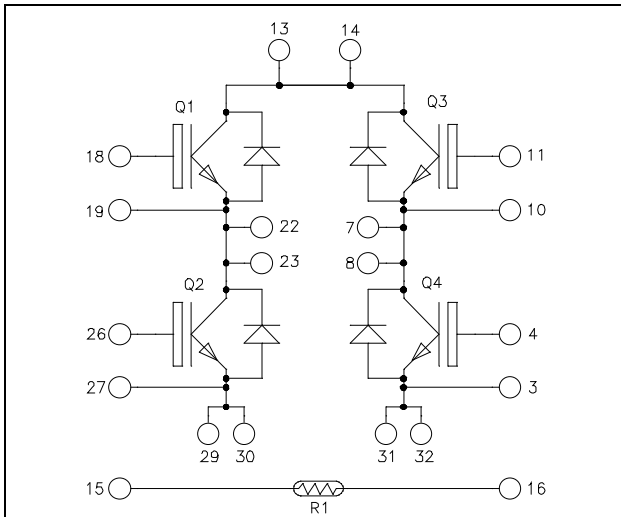

### Application

- Welding converters
- Switched Mode Power Supplies
- Uninterruptible Power Supplies
- Motor control

### Features

- **High speed Trench + Field Stop IGBT 4**
  - Low voltage drop
  - Low leakage current
  - Low switching losses
- Kelvin emitter for easy drive
- Very low stray inductance
- Internal thermistor for temperature monitoring

### Benefits

- Outstanding performance at high frequency operation
- Direct mounting to heatsink (isolated package)
- Low junction to case thermal resistance
- Solderable terminals both for power and signal for easy PCB mounting
- Low profile
- Easy paralleling due to positive TC of  $V_{CESat}$
- Each leg can be easily paralleled to achieve a phase leg of twice the current capability
- RoHS compliant

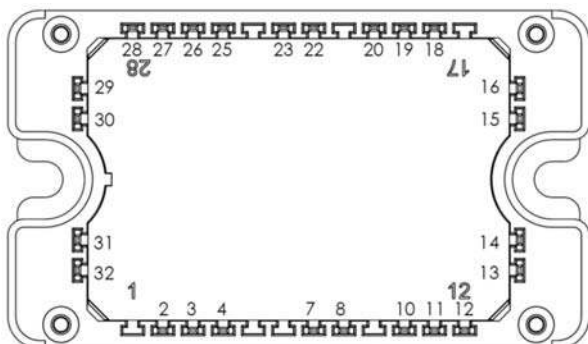

All multiple inputs and outputs must be shorted together  
 Example: 13/14 ; 29/30 ; 22/23 ...

**All ratings @  $T_j = 25^\circ C$  unless otherwise specified**

### Absolute maximum ratings (per IGBT)

Symbol	Parameter	Max ratings	Unit
$V_{CES}$	Collector - Emitter Voltage	1200	V
$I_C$	Continuous Collector Current	$T_c = 25^\circ C$	130
		$T_c = 80^\circ C$	75
$I_{CM}$	Pulsed Collector Current	$T_c = 25^\circ C$	250
$V_{GE}$	Gate - Emitter Voltage	$\pm 20$	V
$P_D$	Power Dissipation	385	W

 **CAUTION:** These Devices are sensitive to Electrostatic Discharge. Proper Handling Procedures Should Be Followed.

**Electrical Characteristics (per IGBT)**

Symbol	Characteristic	Test Conditions	Min	Typ	Max	Unit
I <sub>CES</sub>	Zero Gate Voltage Collector Current	V <sub>GE</sub> = 0V, V <sub>CE</sub> = 1200V			50	μA
V <sub>CE(sat)</sub>	Collector Emitter Saturation Voltage	V <sub>GE</sub> = 15V I <sub>C</sub> = 75A	T <sub>j</sub> = 25°C 1.7	2.05	2.4	V
			T <sub>j</sub> = 150°C 2.6			
V <sub>GE(th)</sub>	Gate Threshold Voltage	V <sub>GE</sub> = V <sub>CE</sub> , I <sub>C</sub> = 2.6 mA	5.0	5.8	6.5	V
I <sub>GES</sub>	Gate – Emitter Leakage Current	V <sub>GE</sub> = 20V, V <sub>CE</sub> = 0V			150	nA

**Dynamic Characteristics (per IGBT)**

Symbol	Characteristic	Test Conditions	Min	Typ	Max	Unit
C <sub>ies</sub>	Input Capacitance	V <sub>GE</sub> = 0V		4400		pF
C <sub>oes</sub>	Output Capacitance	V <sub>CE</sub> = 25V		250		
C <sub>res</sub>	Reverse Transfer Capacitance	f = 1MHz		235		
Q <sub>G</sub>	Gate charge	V <sub>GE</sub> = 15V, I <sub>C</sub> = 75A V <sub>CE</sub> = 960V		325		nC
T <sub>d(on)</sub>	Turn-on Delay Time	Inductive Switching (25°C) V <sub>GE</sub> = ±15V V <sub>Bus</sub> = 600V I <sub>C</sub> = 75A R <sub>G</sub> = 7Ω		30		ns
T <sub>r</sub>	Rise Time			57		
T <sub>d(off)</sub>	Turn-off Delay Time			290		
T <sub>f</sub>	Fall Time			16		
T <sub>d(on)</sub>	Turn-on Delay Time	Inductive Switching (150°C) V <sub>GE</sub> = ±15V V <sub>Bus</sub> = 600V I <sub>C</sub> = 75A R <sub>G</sub> = 7Ω		30		ns
T <sub>r</sub>	Rise Time			49		
T <sub>d(off)</sub>	Turn-off Delay Time			366		
T <sub>f</sub>	Fall Time			48		
E <sub>on</sub>	Turn on Energy	V <sub>GE</sub> = ±15V V <sub>Bus</sub> = 600V I <sub>C</sub> = 75A R <sub>G</sub> = 7Ω	T <sub>j</sub> = 25°C	5.5		mJ
			T <sub>j</sub> = 150°C	6.4		
E <sub>off</sub>	Turn off Energy		T <sub>j</sub> = 25°C	2.05		
			T <sub>j</sub> = 150°C	3.84		
I <sub>sc</sub>	Short Circuit data	V <sub>GE</sub> ≤ 15V ; V <sub>Bus</sub> = 900V t <sub>p</sub> ≤ 10μs ; T <sub>j</sub> = 150°C		260		A
R <sub>thJC</sub>	Junction to Case Thermal Resistance				0.39	°C/W

**Diode ratings and characteristics (per diode)**

Symbol	Characteristic	Test Conditions	Min	Typ	Max	Unit
V <sub>RRM</sub>	Peak Repetitive Reverse Voltage				1200	V
I <sub>RM</sub>	Reverse Leakage Current	V <sub>R</sub> = 1200V			150	μA
I <sub>F</sub>	DC Forward Current	T <sub>c</sub> = 80°C		60		A
V <sub>F</sub>	Diode Forward Voltage	I <sub>F</sub> = 60A		2.6	3.1	V
		I <sub>F</sub> = 120A		3.2		
		I <sub>F</sub> = 60A	T <sub>j</sub> = 125°C	1.8		
t <sub>rr</sub>	Reverse Recovery Time	I <sub>F</sub> = 60A V <sub>R</sub> = 800V di/dt = 400A/μs	T <sub>j</sub> = 25°C	300		ns
			T <sub>j</sub> = 125°C	380		
Q <sub>rr</sub>	Reverse Recovery Charge		T <sub>j</sub> = 25°C	720		nC
			T <sub>j</sub> = 125°C	3400		
R <sub>thJC</sub>	Junction to Case Thermal Resistance				0.65	°C/W

**Temperature sensor NTC** (see application note APT0406 on [www.microsemi.com](http://www.microsemi.com)).

Symbol	Characteristic	Min	Typ	Max	Unit
R <sub>25</sub>	Resistance @ 25°C		50		kΩ
ΔR <sub>25</sub> /R <sub>25</sub>			5		%
B <sub>25/85</sub>	T <sub>25</sub> = 298.15 K		3952		K
ΔB/B	T <sub>C</sub> = 100°C		4		%

$$R_T = \frac{R_{25}}{\exp \left[ B_{25/85} \left( \frac{1}{T_{25}} - \frac{1}{T} \right) \right]}$$

T: Thermistor temperature  
 R<sub>T</sub>: Thermistor value at T

**Thermal and package characteristics**

Symbol	Characteristic	Min	Max	Unit		
V <sub>ISOL</sub>	RMS Isolation Voltage, any terminal to case t=1 min, 50/60Hz	4000		V		
T <sub>J</sub>	Operating junction temperature range	-40	175	°C		
T <sub>JOP</sub>	Recommended junction temperature under switching conditions	-40	T <sub>max</sub> -25			
T <sub>STG</sub>	Storage Temperature Range	-40	125			
T <sub>C</sub>	Operating Case Temperature	-40	125			
Torque	Mounting torque	To heatsink	M4	2	3	N.m
Wt	Package Weight				110	g

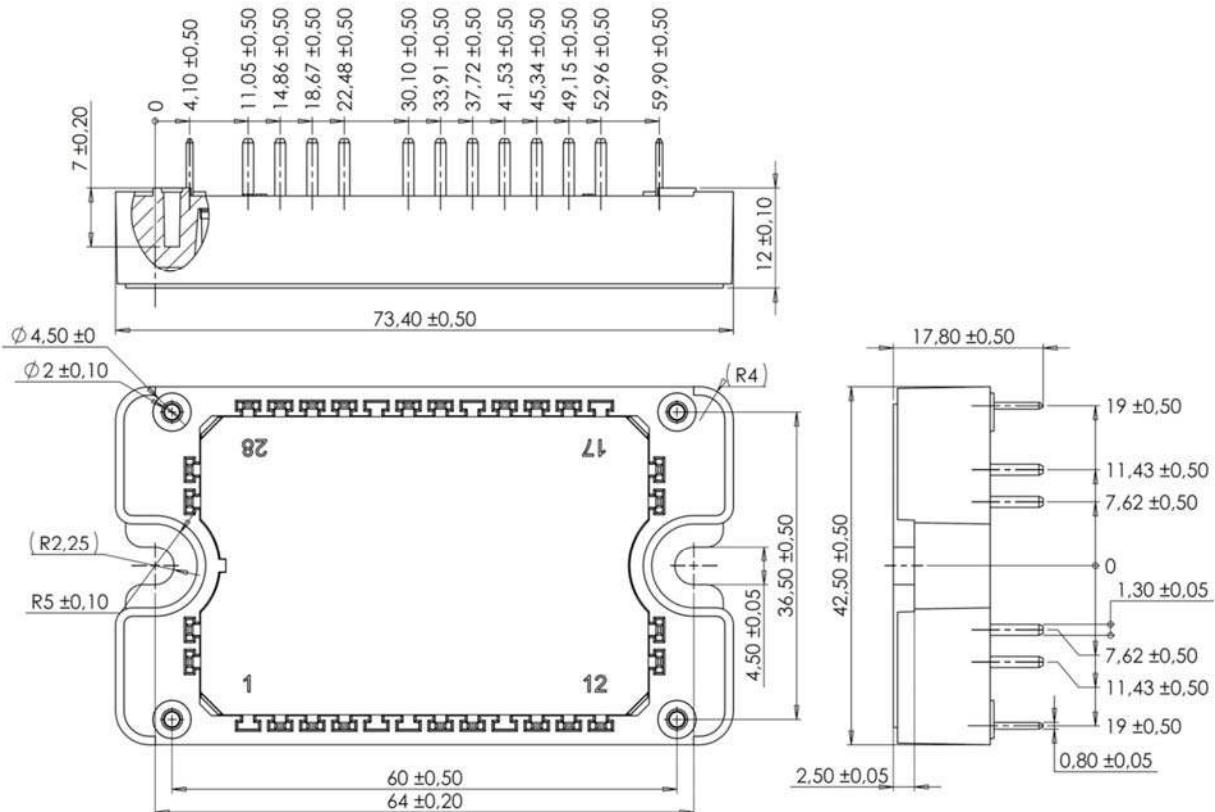
**Package outline (dimensions in mm)**

 See application note 1906 - Mounting Instructions for SP3F Power Modules on [www.microsemi.com](http://www.microsemi.com)

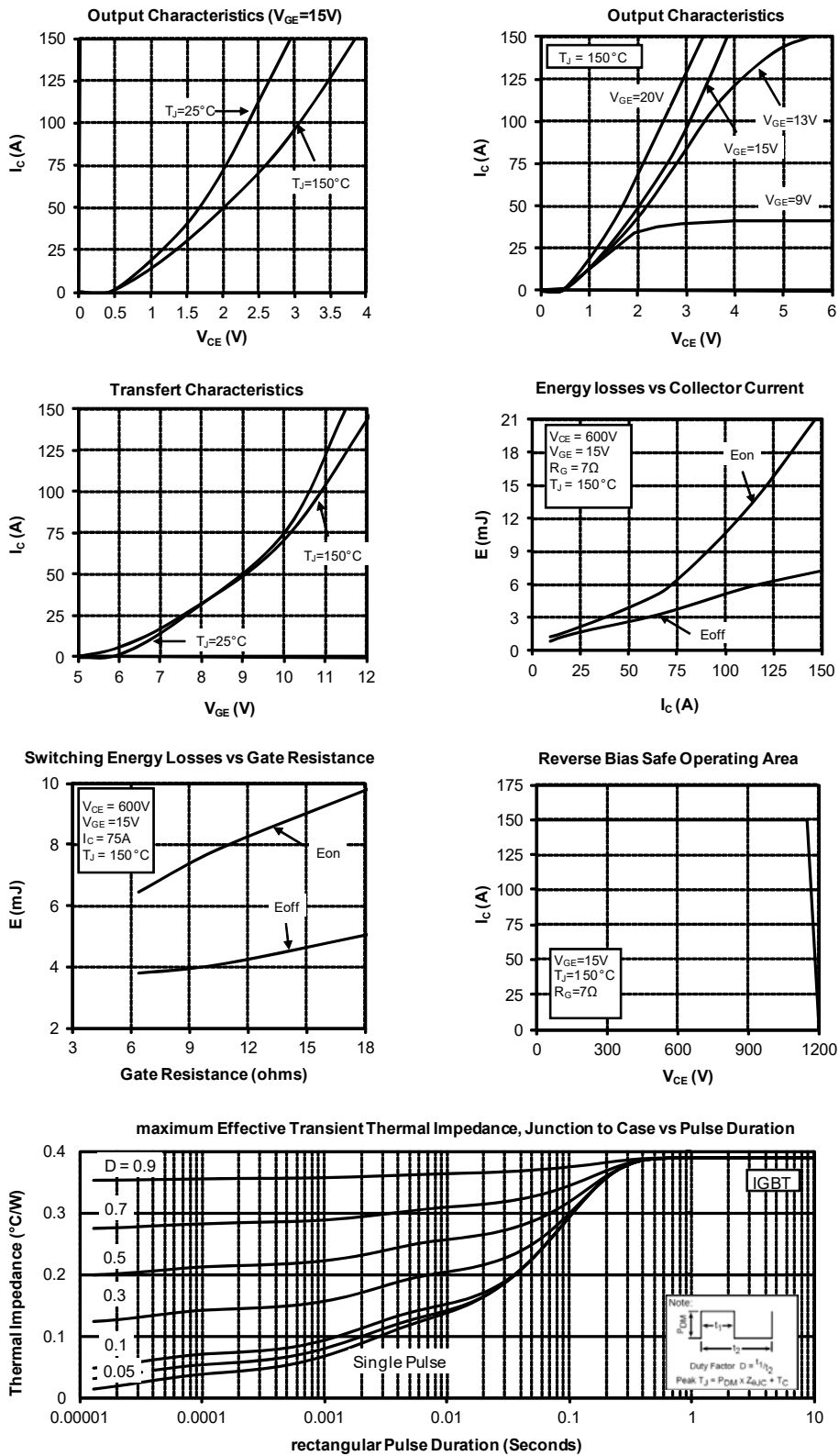
## Typical performance curve

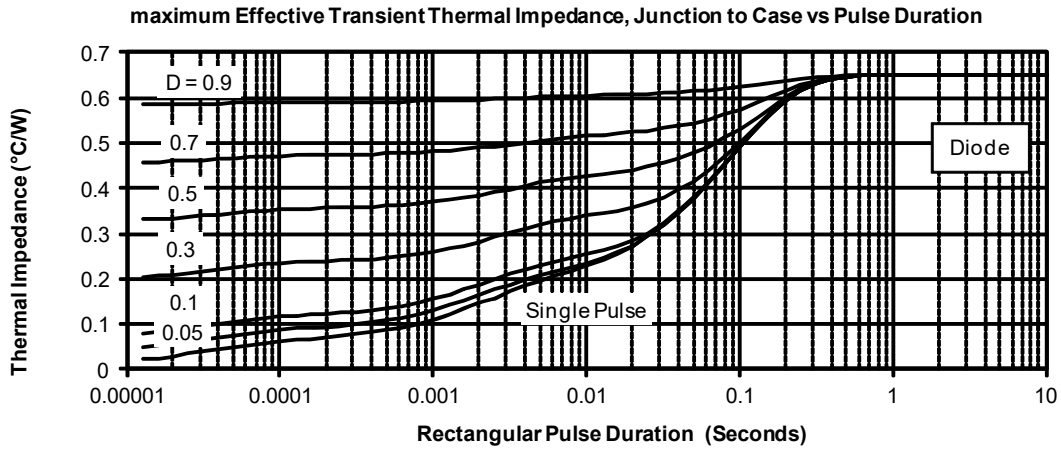
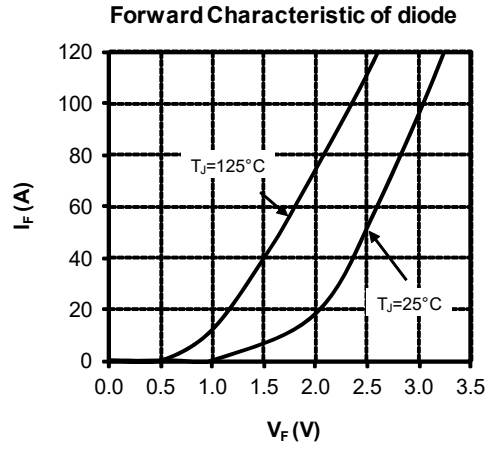
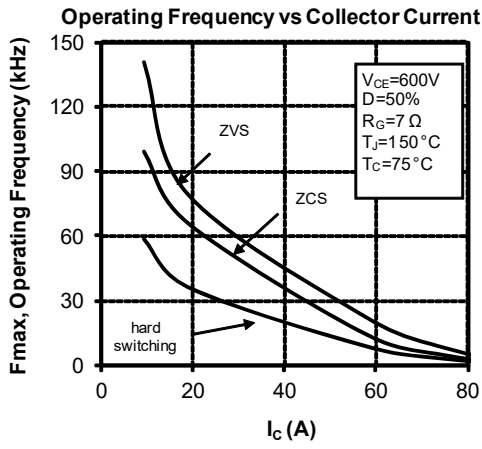



---

DISCLAIMER

The information contained in the document (unless it is publicly available on the Web without access restrictions) is PROPRIETARY AND CONFIDENTIAL information of Microsemi and cannot be copied, published, uploaded, posted, transmitted, distributed or disclosed or used without the express duly signed written consent of Microsemi. If the recipient of this document has entered into a disclosure agreement with Microsemi, then the terms of such Agreement will also apply. This document and the information contained herein may not be modified, by any person other than authorized personnel of Microsemi. No license under any patent, copyright, trade secret or other intellectual property right is granted to or conferred upon you by disclosure or delivery of the information, either expressly, by implication, inducement, estoppels or otherwise. Any license under such intellectual property rights must be approved by Microsemi in writing signed by an officer of Microsemi.

Microsemi reserves the right to change the configuration, functionality and performance of its products at anytime without any notice. This product has been subject to limited testing and should not be used in conjunction with life-support or other mission-critical equipment or applications. Microsemi assumes no liability whatsoever, and Microsemi disclaims any express or implied warranty, relating to sale and/or use of Microsemi products including liability or warranties relating to fitness for a particular purpose, merchantability, or infringement of any patent, copyright or other intellectual property right. Any performance specifications believed to be reliable but are not verified and customer or user must conduct and complete all performance and other testing of this product as well as any user or customers final application. User or customer shall not rely on any data and performance specifications or parameters provided by Microsemi. It is the customer's and user's responsibility to independently determine suitability of any Microsemi product and to test and verify the same. The information contained herein is provided "AS IS, WHERE IS" and with all faults, and the entire risk associated with such information is entirely with the User. Microsemi specifically disclaims any liability of any kind including for consequential, incidental and punitive damages as well as lost profit. The product is subject to other terms and conditions which can be located on the web at <http://www.microsemi.com/legal/tnc.asp>

Life Support Application

Seller's Products are not designed, intended, or authorized for use as components in systems intended for space, aviation, surgical implant into the body, in other applications intended to support or sustain life, or for any other application in which the failure of the Seller's Product could create a situation where personal injury, death or property damage or loss may occur (collectively "Life Support Applications").

Buyer agrees not to use Products in any Life Support Applications and to the extent it does it shall conduct extensive testing of the Product in such applications and further agrees to indemnify and hold Seller, and its officers, employees, subsidiaries, affiliates, agents, sales representatives and distributors harmless against all claims, costs, damages and expenses, and attorneys' fees and costs arising, directly or indirectly, out of any claims of personal injury, death, damage or otherwise associated with the use of the goods in Life Support Applications, even if such claim includes allegations that Seller was negligent regarding the design or manufacture of the goods.

Buyer must notify Seller in writing before using Seller's Products in Life Support Applications. Seller will study with Buyer alternative solutions to meet Buyer application specification based on Sellers sales conditions applicable for the new proposed specific part.