

### Product Summary (Per Leg)

V <sub>RRM</sub> (V)	I <sub>O</sub> (A)	V <sub>F</sub> (MAX) (V) @ +25°C	I <sub>R</sub> (MAX) (mA) @ +25°C
45	10	0.52	0.3

### Description and Applications

Packaged in the robust industry-standard TO263 (D<sup>2</sup>PAK) package, the SBRT20V45CTB provides very low V<sub>F</sub> and excellent reverse leakage stability at high temperatures. It is ideal for use as a rectifier, freewheel diode or blocking diode in:

- DC-DC Converters
- AC-DC Adaptors

### Features and Benefits

- Reduced Ultra-Low Forward Voltage Drop (V<sub>F</sub>); Better Efficiency and Cooler Operation
- Reduced High Temperature Reverse Leakage; Increased Reliability Against Thermal Runaway Failure in High Temperature Operation.
- **Lead-Free Finish; RoHS Compliant (Notes 1 & 2)**
- **Halogen and Antimony Free. "Green" Device (Note 3)**

### Mechanical Data

- Case: TO263 (D<sup>2</sup>PAK)
- Case Material: Molded Plastic, "Green" Molding Compound; UL Flammability Classification Rating 94V-0
- Moisture Sensitivity: Level 1 per J-STD-020
- Terminals: Matte Tin Finish; Solderable per MIL-STD-202, Method 208 (e3)
- Polarity: See Below
- Weight: TO263 (D<sup>2</sup>PAK) – 1.6 grams (Approximate)



TO263  
Top View

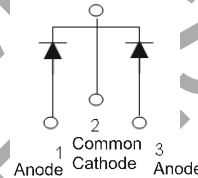

Package Pin-Out  
Configuration

### Ordering Information (Note 4)

Part Number	Case	Packaging
SBRT20V45CTB-13	TO263	800/Tape & Reel

- Notes:
1. EU Directive 2002/95/EC (RoHS) & 2011/65/EU (RoHS 2) compliant. All applicable RoHS exemptions applied.
  2. See [http://www.diodes.com/quality/lead\\_free.html](http://www.diodes.com/quality/lead_free.html) for more information about Diodes Incorporated's definitions of Halogen- and Antimony-free, "Green" and Lead-free.
  3. Halogen- and Antimony-free "Green" products are defined as those which contain <900ppm bromine, <900ppm chlorine (<1500ppm total Br + Cl) and <1000ppm antimony compounds.
  4. For packaging details, go to our website at <http://www.diodes.com/products/packages.html>.

### Marking Information



SBRT20V45CTB = Product Type Marking Code  
 AB = Foundry and Assembly Code  
 YYWW = Date Code Marking  
 YY = Last Two Digits of Year (ex: 14 = 2014)  
 WW = Week (01 - 53)

**Maximum Ratings** (@ $T_A = +25^\circ\text{C}$ , unless otherwise specified.)

Single phase, half wave, 60Hz, resistive or inductive load.  
For capacitance load, derate current by 20%.

Characteristic	Symbol	Value	Unit
Peak Repetitive Reverse Voltage	$V_{RRM}$	45	V
Working Peak Reverse Voltage	$V_{RWM}$		
DC Blocking Voltage	$V_{RM}$		
Average Rectified Output Current (Per Leg) (Total)	$I_O$	10 20	A
Non-Repetitive Peak Forward Surge Current 8.3ms Single Half Sine-Wave Superimposed on Rated Load (Per Leg)	$I_{FSM}$	180	A

**Thermal Characteristics (Per Leg)**

Characteristic	Symbol	Value	Unit
Typical Thermal Resistance, Junction to Case (Note 5)	$R_{\theta JC}$	4	$^\circ\text{C/W}$
Operating and Storage Temperature Range	$T_J, T_{STG}$	-55 to +150	$^\circ\text{C}$

**Electrical Characteristics (Per Leg)** (@ $T_A = +25^\circ\text{C}$ , unless otherwise specified.)

Characteristic	Symbol	Min	Typ	Max	Unit	Test Condition
Forward Voltage Drop (Note 6)	$V_F$	—	0.46	0.52	V	$I_F = 10\text{A}, T_J = +25^\circ\text{C}$
		—	0.43	0.49		$I_F = 10\text{A}, T_J = +125^\circ\text{C}$
		—	0.58	0.62		$I_F = 20\text{A}, T_J = +25^\circ\text{C}$
Leakage Current (Note 6)	$I_R$	—	0.05	0.30	mA	$V_R = 45\text{V}, T_J = +25^\circ\text{C}$
		—	—	50		$V_R = 45\text{V}, T_J = +125^\circ\text{C}$

Notes: 5. Test with Aluminum heatsink 50mm\*50mm\*23mm.  
6. Short duration pulse test used to minimize self-heating effect.

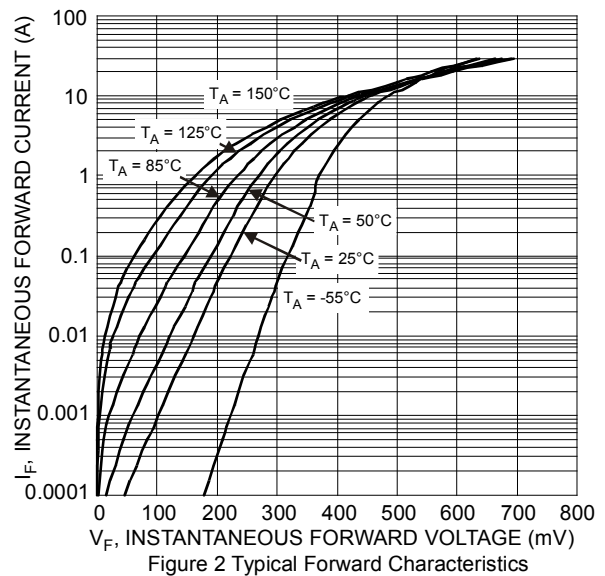
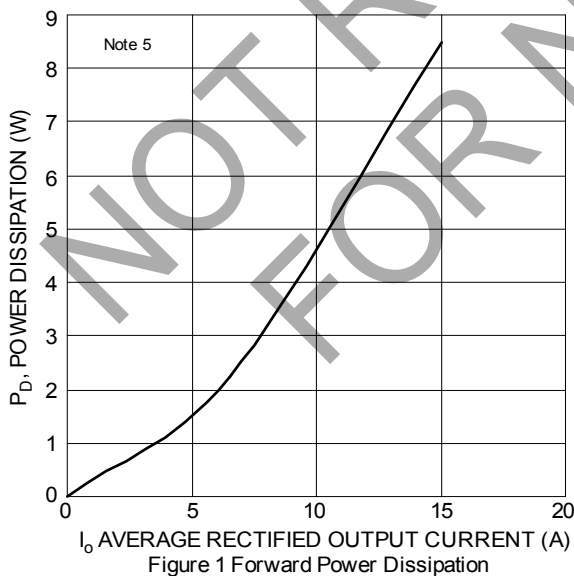

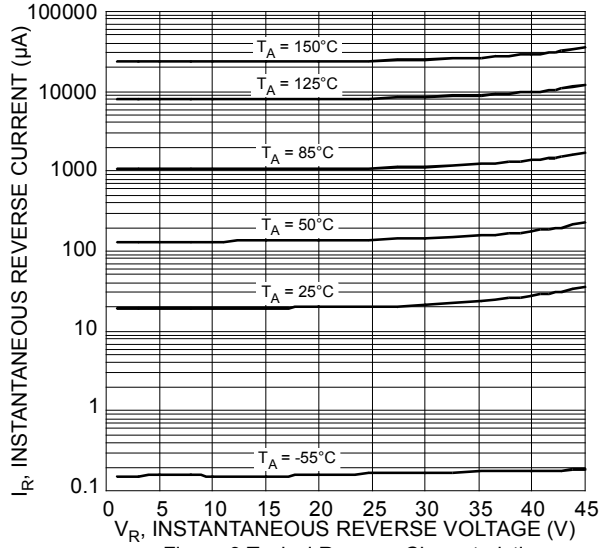

Figure 3 Typical Reverse Characteristics

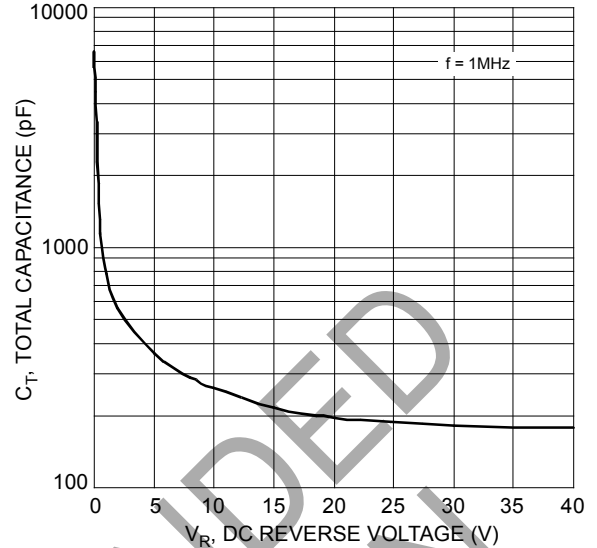

Figure 4 Total Capacitance vs. Reverse Voltage

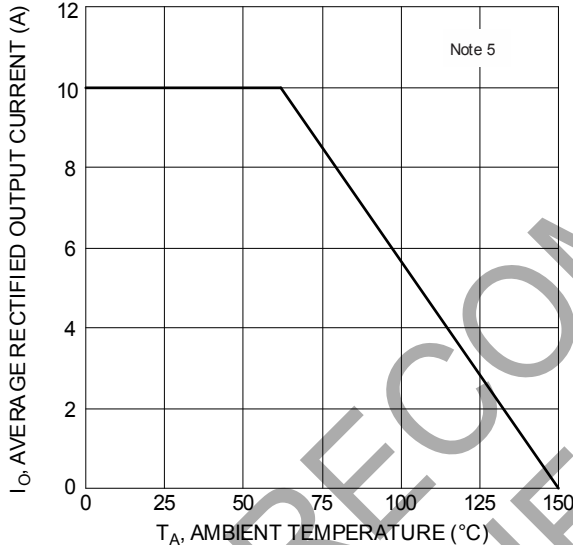
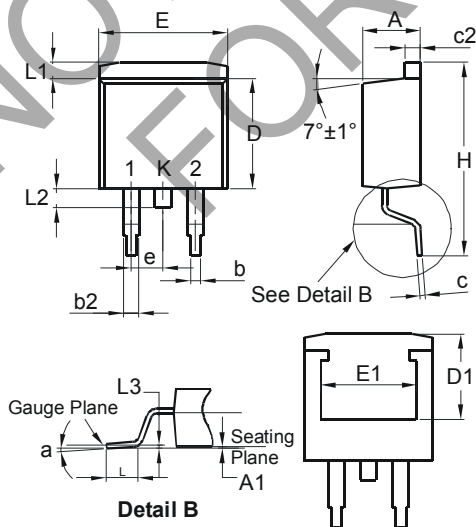

Figure 5 Forward Current Derating Curve

### Package Outline Dimensions

Please see AP02002 at <http://www.diodes.com/datasheets/ap02002.pdf> for latest version.



TO263		
Dim	Min	Max
A	4.07	4.82
A1	0.00	0.25
b	0.51	0.99
b2	1.15	1.77
c	0.356	0.73
c2	1.143	1.65
D	8.39	9.65
D1	6.55	—
E	9.66	10.66
E1	6.23	—
e	2.54 Typ	
H	14.61	15.87
L	1.78	2.79
L1	—	1.67
L2	—	1.77
a	$0^\circ$	$8^\circ$
All Dimensions in mm		

**Suggested Pad Layout**

Please see AP02001 at <http://www.diodes.com/datasheets/ap02001.pdf> for the latest version.

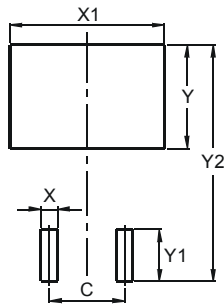

Dimensions	Value (in mm)
C	5.08
X	1.10
X1	10.41
Y	3.50
Y1	7.01
Y2	15.99

NOT RECOMMENDED FOR NEW DESIGN

**IMPORTANT NOTICE**

1. DIODES INCORPORATED AND ITS SUBSIDIARIES (“DIODES”) MAKE NO WARRANTY OF ANY KIND, EXPRESS OR IMPLIED, WITH REGARDS TO ANY INFORMATION CONTAINED IN THIS DOCUMENT, INCLUDING, BUT NOT LIMITED TO, THE IMPLIED WARRANTIES OF MERCHANTABILITY, FITNESS FOR A PARTICULAR PURPOSE OR NON-INFRINGEMENT OF THIRD PARTY INTELLECTUAL PROPERTY RIGHTS (AND THEIR EQUIVALENTS UNDER THE LAWS OF ANY JURISDICTION).
2. The Information contained herein is for informational purpose only and is provided only to illustrate the operation of Diodes products described herein and application examples. Diodes does not assume any liability arising out of the application or use of this document or any product described herein. This document is intended for skilled and technically trained engineering customers and users who design with Diodes products. Diodes products may be used to facilitate safety-related applications; however, in all instances customers and users are responsible for (a) selecting the appropriate Diodes products for their applications, (b) evaluating the suitability of the Diodes products for their intended applications, (c) ensuring their applications, which incorporate Diodes products, comply the applicable legal and regulatory requirements as well as safety and functional-safety related standards, and (d) ensuring they design with appropriate safeguards (including testing, validation, quality control techniques, redundancy, malfunction prevention, and appropriate treatment for aging degradation) to minimize the risks associated with their applications.
3. Diodes assumes no liability for any application-related information, support, assistance or feedback that may be provided by Diodes from time to time. Any customer or user of this document or products described herein will assume all risks and liabilities associated with such use, and will hold Diodes and all companies whose products are represented herein or on Diodes’ websites, harmless against all damages and liabilities.
4. Products described herein may be covered by one or more United States, international or foreign patents and pending patent applications. Product names and markings noted herein may also be covered by one or more United States, international or foreign trademarks and trademark applications. Diodes does not convey any license under any of its intellectual property rights or the rights of any third parties (including third parties whose products and services may be described in this document or on Diodes’ website) under this document.
5. Diodes products are provided subject to Diodes’ Standard Terms and Conditions of Sale (<https://www.diodes.com/about/company/terms-and-conditions/terms-and-conditions-of-sales/>) or other applicable terms. This document does not alter or expand the applicable warranties provided by Diodes. Diodes does not warrant or accept any liability whatsoever in respect of any products purchased through unauthorized sales channel.
6. Diodes products and technology may not be used for or incorporated into any products or systems whose manufacture, use or sale is prohibited under any applicable laws and regulations. Should customers or users use Diodes products in contravention of any applicable laws or regulations, or for any unintended or unauthorized application, customers and users will (a) be solely responsible for any damages, losses or penalties arising in connection therewith or as a result thereof, and (b) indemnify and hold Diodes and its representatives and agents harmless against any and all claims, damages, expenses, and attorney fees arising out of, directly or indirectly, any claim relating to any noncompliance with the applicable laws and regulations, as well as any unintended or unauthorized application.
7. While efforts have been made to ensure the information contained in this document is accurate, complete and current, it may contain technical inaccuracies, omissions and typographical errors. Diodes does not warrant that information contained in this document is error-free and Diodes is under no obligation to update or otherwise correct this information. Notwithstanding the foregoing, Diodes reserves the right to make modifications, enhancements, improvements, corrections or other changes without further notice to this document and any product described herein. This document is written in English but may be translated into multiple languages for reference. Only the English version of this document is the final and determinative format released by Diodes.
8. Any unauthorized copying, modification, distribution, transmission, display or other use of this document (or any portion hereof) is prohibited. Diodes assumes no responsibility for any losses incurred by the customers or users or any third parties arising from any such unauthorized use.

Copyright © 2021 Diodes Incorporated

[www.diodes.com](http://www.diodes.com)