

E20600

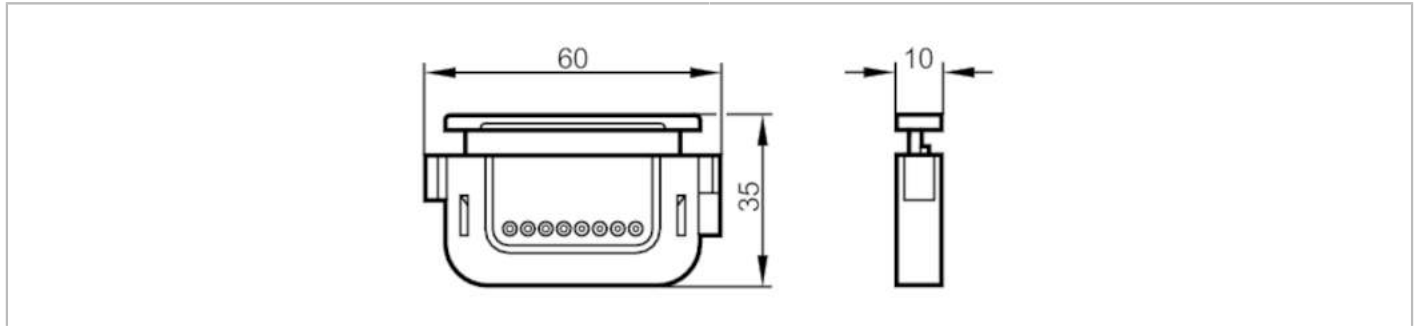

Cutter for fibre optics

CUTTER FOR FIBRE OPTICS



Mechanical data

Weight	[g]	17.2
Materials		plastics

Remarks

Pack quantity		1 pcs.
---------------	--	--------