



Features:

- Universal AC input/ Full Range
- Energy Efficiency Level VI
- ErP Step 2 Compliant
- NRCAN and GEMS Compliant
- Output Protections: OVP/SCP/OC
- No Load Power Consumption <0.1W
- 1 Year Warranty



Model	QAWA-30-5	QAWA-30-7.5	QAWA-30-8.5	QAWA-30-9	QAWA-30-12	QAWA-36-13.5	QAWA-36-15	QAWA-36-16	QAWA-36-18	QAWA-36-24	QAWA-36-48
Output Characteristics											
DC Output	5V	7.5V	8.5V	9V	12V	13.5V	15V	16V	18V	24V	48V
Rated Current	5.0A	4.0A	3.52A	3.34A	3.0A	2.66A	2.40A	2.25A	2.00A	1.5A	0.75A
Ripple and Noise	±2% Vo @ Rated Load										
Load Regulation (Typ.)	±5%										
Transient Response (Typ.)	0.5mS for 50% Load Change										
Hold-up Time (Typ.)	10mS @ Rated Load										
Output Protection	Short Circuit, Over Voltage, Over Current										
Ferrite Core	No										
Input Characteristics											
Voltage Range	100VAC~240VAC										
Frequency Range	50Hz-60Hz										
Efficiency	DoE Level VI, Energy Star, ErP Step 2, NRCAN & GEMS LEVEL VI Certified										
AC Current (max)	1.0A										
Input Protection	Internal Primary Current Fuse, Inrush Limiting										
Leakage Current	0.25mA										
Environmental Characteristics											
Operating Temperature	0°C~40°C										
Operating Relative Humidity	20% RH to 80% RH										
Storage Temperature	-20°C~80°C, 10% RH to 90% RH										
Topology	Switching Flyback										
Dielectric Withstand	3000VAC Primary-Secondary										
EMI Conduction & Radiation	Compliance to EN55022 Class B										
Harmonic Current	Compliance to EN61000-3-2, 3										
EMS Immunity	IEC61000-4-2, 3, 4, 5, 6, 8, 11										
Characteristics											
MTBF	300,000Hrs (25°C, Telecordia SR-332)										
Dimension (LxWxH)	79x34x74mm (US), 79x34x94mm (EU), 79x49x86mm (UK), 79x41x82 (AU)										
Weight	160g										

Note: Safety Approvals
 EU: CB, CE, LPS
 UK: CB, CE, LPS
 US: CB, UL, cUL, FCC, PSE, BSMI, LPS
 AU: CB, RCM, LPS

PART NUMBER SYSTEM

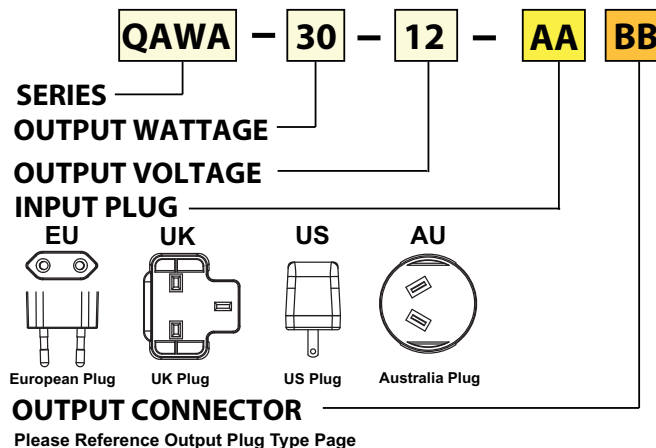

MECHANICAL SPECIFICATIONS

QAWA-30/36-XX-EU

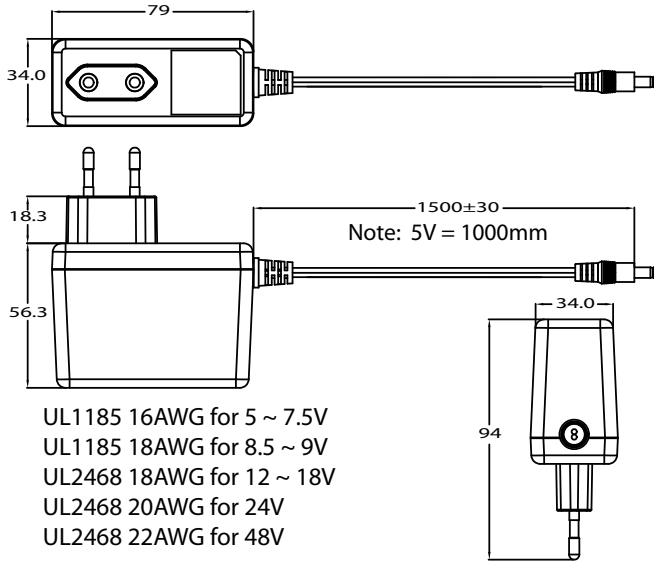

QAWA-30/36-XX-UK

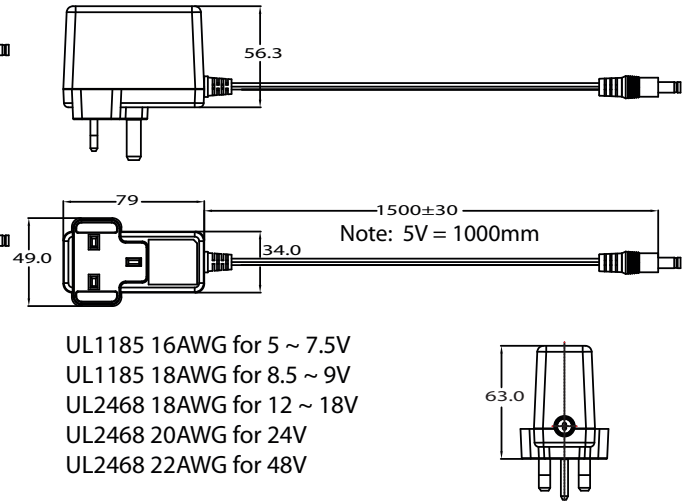

QAWA-30/36-XX-US

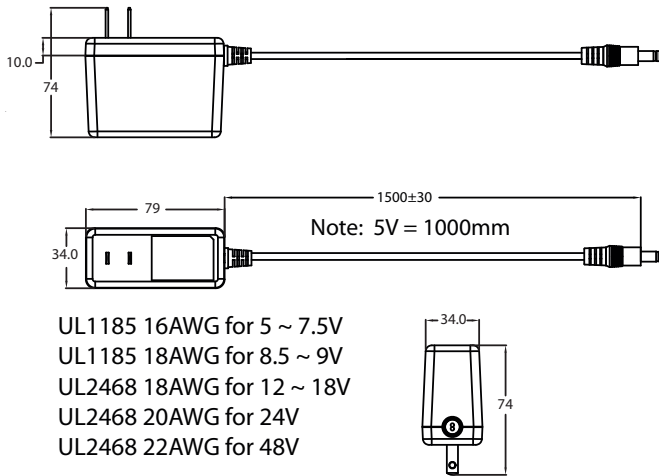

QAWA-30/36-XX-AU

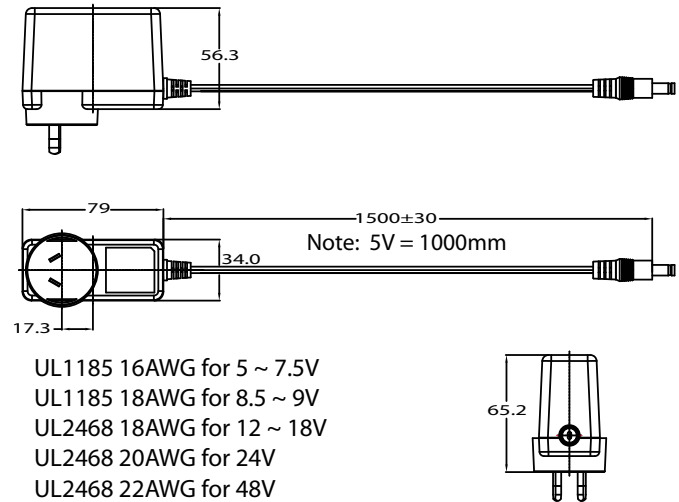

DERATING CURVE

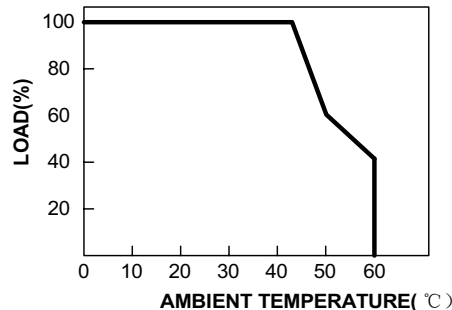

UNIT: mm