



REED SWITCH DEVELOPMENTS CORP.

2524 Norwood Court
Racine, WI 53403
Ph: (262)883-9060

sales@reedswitchdevelopments.com

SPECIFICATION SHEET

2010-4002-000

Alternate Part Numbers:
AM2010-4002-00-01
3730-2010-4002-000-ND

Active / Equivalent Part Numbers:

2010-4002-000 - Magnetic Actuator Only

AM2010-4002-00-01 - Magnetic Actuator Only

3730-2010-4002-000-ND - Magnetic Actuator Only

2010 Series Magnetic Reed Switch Actuator

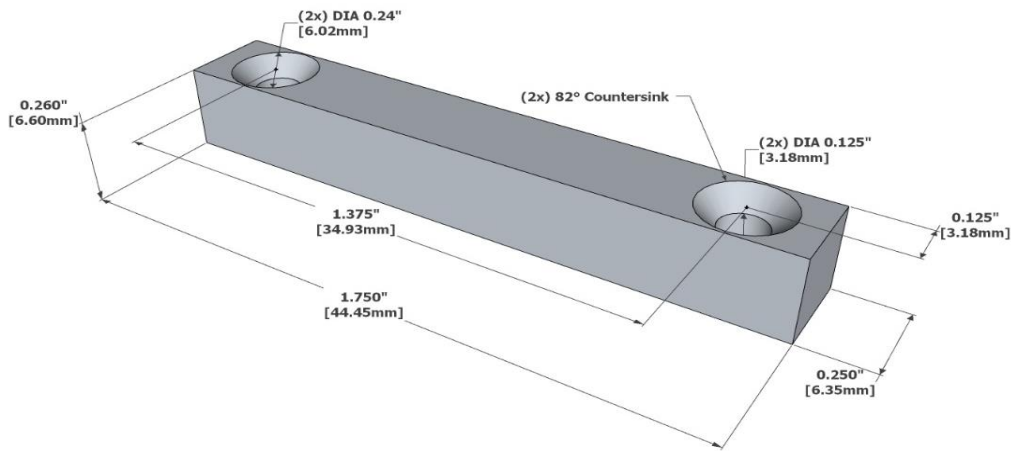

All measurements are in inches [millimeters]

Specifications	Description	UM
Shape	Rectangular with Mounting Holes	
Length	1.75"/44.45mm	in/mm
Width	0.25"/6.35mm	in/mm
Height	0.26"/6.60mm	in/mm
Housing Material	Celanex 3316	
Magnetic Orientation	Through Length	
Max Operating Temperature	975/525	°F/°C
Curie Temperature	1580/860	°F/°C
BR max	12.8	kGauss
BH max	5.5	MGOe
Coercive Force Hc	640	kOe
Intrinsic Coercive Force Hci	640	kOe

Assembly Certifications

RoHS / REACH Compliant	Y
Conflict Free Material	Y

REV DATE: 04/20/2023

DISCLAIMER NOTICE: INFORMATION FURNISHED IS PROPRIETARY, AND IS BELIEVED TO BE ACCURATE AND RELIABLE, AND IS SUBJECT TO CHANGE WITHOUT NOTICE. IT SHALL BE THE RESPONSIBILITY OF THE BUYER TO ENSURE THAT THE GOODS ARE SUFFICIENT AND SUITABLE FOR THE PURPOSE OR PURPOSES INTENDED (WHETHER BY THE BUYER OR BY ANY THIRD PARTY) AND THAT THEIR CAPACITY AND PERFORMANCE IS NOT ADVERSELY AFFECTED BY ANY ITEMS USED IN THEIR INSTALLATION (WHERE RELEVANT) AND/OR IN CONNECTION WITH THEM.

WBE Certified - State of Wisconsin - MFR CAGE CODE: 32604

www.reedswitchdevelopments.com