

CUSTOMER PRINT

PART NUMBER: 8382-XPG-3XX

NOTES:
 1. ALL PARTS TO BE BULK PACKED.
 2. ALL DIMENSIONS ARE REFERENCE EXCEPT THOSE WITH A TOLERANCE.

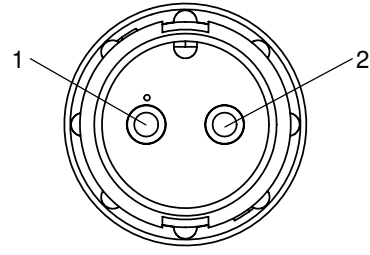

FACE VIEW
8382-2PG-3XX

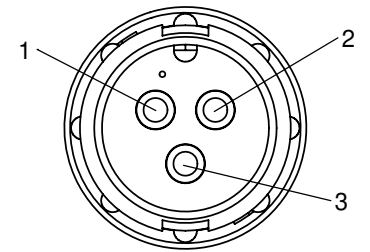

FACE VIEW
8382-3PG-3XX

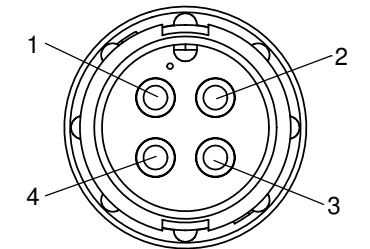

FACE VIEW
8382-4PG-3XX

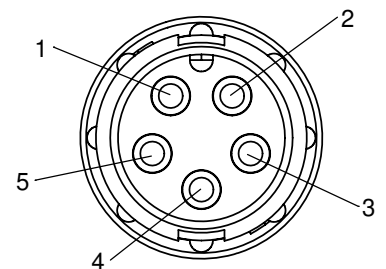

FACE VIEW
8382-5PG-3XX

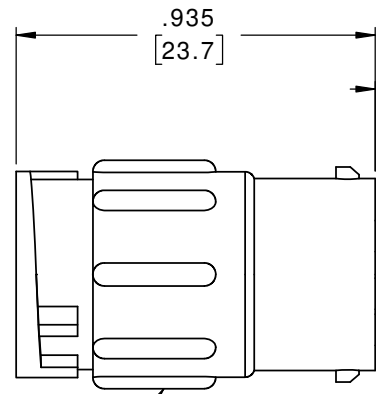

CABLE CONNECTOR, MALE
MAT'L: NYLON, BLACK

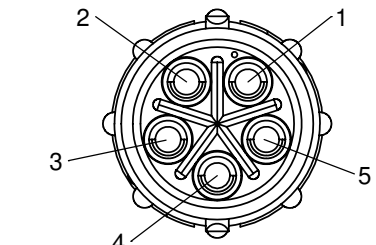

WIRE VIEW
8382-5PG-3XX

DAISY CHAIN GROMMET
FOR 8382-XPG-3DC
MAT'L: RUBBER, BLACK

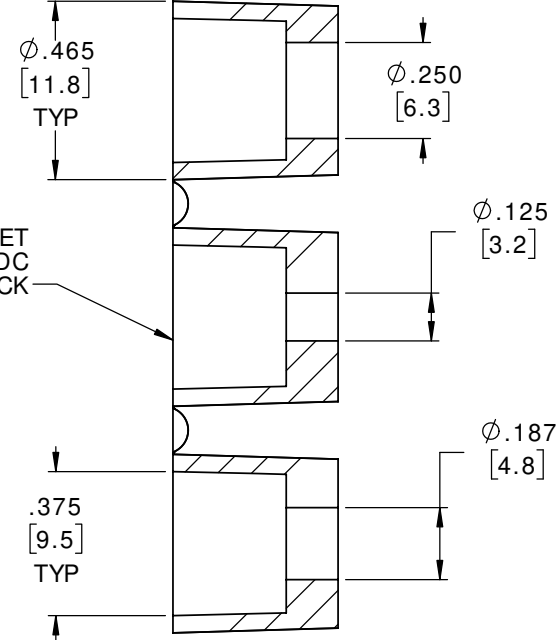

SINGLE GROMMET
 8382-XPG-311 .125 I.D. FOR CABLE .09-.14 O.D. [2.3-3.6]
 8382-XPG-315 .188 I.D. FOR CABLE .15-.17 O.D. [3.8-4.3]
 8382-XPG-318 .156 I.D. FOR CABLE .18-.20 O.D. [4.6-5.1]
 8382-XPG-321 .225 I.D. FOR CABLE .21-.23 O.D. [5.3-5.8]

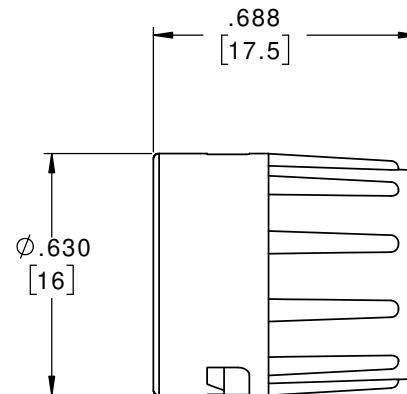

BACKSHELL
MAT'L: NYLON, BLACK

ASS'Y P/N	GROMMET SIZE
8382-XPG-3DC	DAISY CHAIN
8382-XPG-311	CABLE O.D. .09-0.14 [2.3-3.6]
8382-XPG-315	CABLE O.D. .15-.17 [3.8-4.3]
8382-XPG-318	CABLE O.D. .18-.20 [4.6-5.1]
8382-XPG-321	CABLE O.D. .21-.23 [5.3-5.8]

KIT P/N	NO. OF CONTACTS
8382-2PG-3XX	2
8283-3PG-3XX	3
8283-4PG-3XX	4
8283-5PG-3XX	5
8283-XPG-3XX	

GROMMET SIZE FOR SINGLE GROMMET OR "DC" FOR DAISY CHAIN

NO. OF CONTACTS

CUSTOMER APPROVAL

THIS DOCUMENT CONTAINS CONFIDENTIAL INFORMATION PROPRIETARY TO CONXALL CORPORATION. ANY REPRODUCTION, DISCLOSURE, OR USE OF THIS DOCUMENT / INFORMATION IS EXPRESSLY PROHIBITED UNLESS AUTHORIZED IN WRITING BY CONXALL CORPORATION.

APPROVED BY: _____
 DATE: _____

A	MA	02-12-18	DRAWING CREATED PER DOR 15-E253SL #20	
REV.	INIT.	DATE	DESCRIPTION	
	MA	02-12-18	ORIG. DRAWN BY: _____ DATE: 02-12-18 CHECKED BY: _____  601 E. WILDWOOD VILLA PARK, IL 60181	
ALL INFORMATION ILLUSTRATED IS THE PROPERTY OF CONXALL CORPORATION. UNAUTHORIZED DUPLICATION OR DISTRIBUTION OF THIS DOCUMENT IS PROHIBITED.			APPROVED BY: _____ TITLE: CONNECTOR ASSEMBLY (2-5) #16 PIN CONTACTS MINI-CON-X STANDARD PRODUCT	
ALL UNITS ARE IN FEET, INCHES, FRACTION OF INCHES AND DECIMALS.			CUSTOMER: STANDARD PRODUCT	
SCALE: NTS SIZE: B SHEET: 1 OF 1			PART NUMBER: 8382-XPG-3XX	
FILE: 8382-XPG-3XX DIRECTORY: SLW			REV: A	

DIMENSIONS IN BRACKETS [] ARE METRIC

RoHS COMPLIANT