

FEATURES

- Yaw rate gyroscope with digital range scaling
 - $\pm 80^\circ/\text{sec}$, $\pm 160^\circ/\text{sec}$, and $\pm 320^\circ/\text{sec}$ settings
- 14-bit digital gyroscope sensor outputs
- 12-bit digital temperature sensor output
- Calibrated sensitivity and bias
 - ADIS16250: $+25^\circ\text{C}$
 - ADIS16255: -40°C to $+85^\circ\text{C}$
- In-system, auto-zero for bias drift calibration
- Digitally controlled sample rate
- Digitally controlled frequency response
- Dual alarm settings with configurable operation
- Embedded integration for short-term angle estimates
- Digitally activated self-test
- Digitally activated low power mode
 - Interrupt-driven wake-up
- SPI[®]-compatible serial interface
- 50 Hz sensor bandwidth
- Auxiliary 12-bit ADC input and 12-bit DAC output
- Auxiliary digital input/output
- Single-supply operation: 4.75 V to 5.25 V
- 2000 g powered shock survivability

GENERAL DESCRIPTION

The ADIS16250/ADIS16255 are complete angular rate measurement systems available in a single compact package enabled by Analog Devices, Inc. *iSensor*[™] integration. By enhancing Analog Devices *iMEMS*[®] sensor technology with an embedded signal processing solution, the ADIS16250/ADIS16255 provide factory-calibrated and tunable digital sensor data in a convenient format that can be accessed using a simple SPI serial interface. The ADIS16255 additionally provides an extended temperature calibration. The SPI interface provides access to measurements for the gyroscope, temperature, power supply, and one auxiliary analog input. Easy access to calibrated digital sensor data provides developers with a system-ready device, reducing development time, cost, and program risk.

APPLICATIONS

- Instrumentation control
- Platform control and stabilization
- Motion control and analysis
- Avionics instrumentation
- Navigation
- Image stabilization
- Robotics

FUNCTIONAL BLOCK DIAGRAM

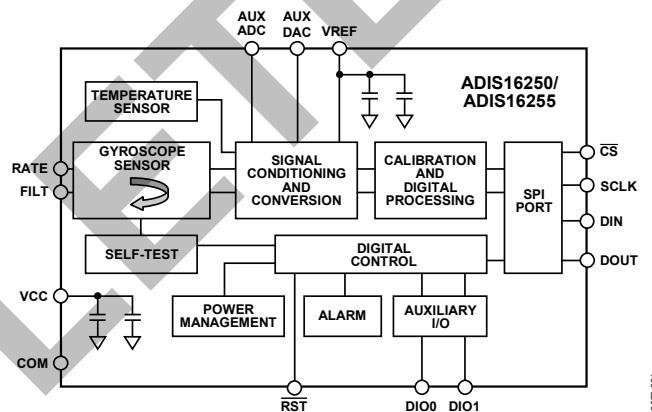

Figure 1.

The device range can be digitally selected from three different settings: $\pm 80^\circ/\text{sec}$, $\pm 160^\circ/\text{sec}$, and $\pm 320^\circ/\text{sec}$. Unique characteristics of the end system are accommodated easily through several built-in features, including a single-command auto-zero recalibration function, as well as configurable sample rate and frequency response. Additional features can be used to further reduce system complexity, including:

- Configurable alarm function
- Auxiliary 12-bit ADC and DAC
- Two configurable digital I/O ports
- Digital self-test function

System power dissipation can be optimized via the ADIS16250/ADIS16255 power management features, including an interrupt-driven wake-up. The ADIS16250/ADIS16255 are available in an 11 mm × 11 mm × 5.5 mm, laminate-based land grid array (LGA) package with a temperature range of -40°C to $+85^\circ\text{C}$.

Rev. D

Information furnished by Analog Devices is believed to be accurate and reliable. However, no responsibility is assumed by Analog Devices for its use, nor for any infringements of patents or other rights of third parties that may result from its use. Specifications subject to change without notice. No license is granted by implication or otherwise under any patent or patent rights of Analog Devices. Trademarks and registered trademarks are the property of their respective owners.

TABLE OF CONTENTS

Features	1	Factory Calibration	10
Applications.....	1	Auxiliary ADC Function.....	10
Functional Block Diagram	1	Basic Operation	11
General Description	1	Serial Peripheral Interface (SPI).....	11
Revision History	2	Data Output Register Access	12
Specifications.....	3	Programming and Control.....	13
Timing Specifications	5	Control Register Overview	13
Absolute Maximum Ratings.....	6	Control Register Structure.....	13
ESD Caution.....	6	Calibration.....	14
Pin Configuration and Function Descriptions.....	7	Global Commands	14
Recommended Layout	7	Operational Control.....	15
Typical Performance Characteristics	8	Status and Diagnostics	16
Theory of Operation	10	Outline Dimensions	20
Overview.....	10	Ordering Guide	20
Relative Angle Estimate.....	10		

REVISION HISTORY

11/09—Rev. C to Rev. D

Changes to Flash Memory, Endurance Parameter, Table 1.....	4
Changes to Figure 16.....	9
Changes to Control Register Structure Section.....	13

11/08—Rev. B to Rev. C

Deleted Temperature Sensor Parameter, Table 1.....	3
Added Logic Inputs Conditions and Digital Outputs Conditions	4

3/07—Rev. A to Rev. B

Changes to Table 2 and Figure 2.....	5
Changes to Table 8.....	13
Changes to Table 9 and Table 11.....	14
Changes to Table 24.....	16
Changes to Data-Ready I/O Indicator Section.....	17
Changes to Self-Test Section	17

2/07—Rev. 0 to Rev. A

Added ADIS16255.....	Universal
Changes to Table 1.....	3
Changes to Table 2.....	5
Changes to Figure 2.....	5
Changes to Typical Performance Characteristics.....	8
Deleted Temperature Sensor Section.....	11
Added Factory Calibration Section.....	11
Changes to Table 7.....	12
Changes to Table 8.....	13
Changes to Table 11	14
Changes to Table 19	16
Changes to Flash Memory Endurance Section	18
Changes to Ordering Guide	20

10/06—Revision 0: Initial Version

SPECIFICATIONS

$T_A = -40^{\circ}\text{C}$ to $+85^{\circ}\text{C}$, $V_{CC} = 5.0\text{ V}$, angular rate = $0^{\circ}/\text{sec}$, $\pm 1\text{ g}$, $\pm 320^{\circ}/\text{sec}$ range setting, unless otherwise noted.

Table 1.

Parameter	Conditions	Min	Typ	Max	Unit
SENSITIVITY ¹	Clockwise rotation is positive output				
	25°C, dynamic range = $\pm 320^{\circ}/\text{sec}^2$		0.07326		$^{\circ}/\text{sec}/\text{LSB}$
	25°C, dynamic range = $\pm 160^{\circ}/\text{sec}$		0.03663		$^{\circ}/\text{sec}/\text{LSB}$
	25°C, dynamic range = $\pm 80^{\circ}/\text{sec}$		0.01832		$^{\circ}/\text{sec}/\text{LSB}$
	Initial Tolerance	25°C, dynamic range = $\pm 320^{\circ}/\text{sec}$		± 0.2	± 1
Temperature Coefficient	ADIS16250 (see Figure 8)		225		ppm/ $^{\circ}\text{C}$
	ADIS16255 (see Figure 11)		25		ppm/ $^{\circ}\text{C}$
Nonlinearity	Best fit straight line		0.1		% of FS
BIAS					
In Run Bias Stability	25°C, 1σ		0.016		$^{\circ}/\text{sec}$
Turn-On-to-Turn-On Bias Stability	25°C, 1σ		0.05		$^{\circ}/\text{sec}$
Angular Random Walk	25°C, 1σ		3.6		$^{\circ}/\sqrt{\text{hour}}$
Temperature Coefficient	ADIS16250 (see Figure 7)		0.03		$^{\circ}/\text{sec}/^{\circ}\text{C}$
	ADIS16255 (see Figure 10)		0.005		$^{\circ}/\text{sec}/^{\circ}\text{C}$
Linear Acceleration Effect	Any axis		0.2		$^{\circ}/\text{sec}/\text{g}$
Voltage Sensitivity	$V_{CC} = 4.75\text{ V}$ to 5.25 V		1.0		$^{\circ}/\text{sec}/\text{V}$
NOISE PERFORMANCE					
Output Noise	At 25°C, $\pm 320^{\circ}/\text{sec}$ range, no filtering		0.48		$^{\circ}/\text{sec rms}$
	At 25°C, $\pm 160^{\circ}/\text{sec}$ range, 4-tap filter setting		0.28		$^{\circ}/\text{sec rms}$
	At 25°C, $\pm 80^{\circ}/\text{sec}$ range, 16-tap filter setting		0.14		$^{\circ}/\text{sec rms}$
Rate Noise Density	At 25°C, $f = 25\text{ Hz}$, $\pm 320^{\circ}/\text{sec}$ range, no filtering		0.056		$^{\circ}/\text{sec}/\sqrt{\text{Hz rms}}$
FREQUENCY RESPONSE					
3 dB Bandwidth	See the Analog Bandwidth section for adjustment		50		Hz
Sensor Resonant Frequency			14		kHz
SELF-TEST STATE					
Change for Positive Stimulus	$320^{\circ}/\text{sec}$ dynamic range setting	439	721	1092	LSB
Change for Negative Stimulus	$320^{\circ}/\text{sec}$ dynamic range setting	-439	-721	-1092	LSB
Internal Self-Test Cycle Time			20		ms
ADC INPUT					
Resolution			12		Bits
Integral Nonlinearity			± 2		LSB
Differential Nonlinearity			± 1		LSB
Offset Error			± 4		LSB
Gain Error			± 2		LSB
Input Range		0		2.5	V
Input Capacitance	During acquisition		20		pF
ON-CHIP VOLTAGE REFERENCE					
Accuracy	At 25°C	-10	2.5	+10	V
Temperature Coefficient			± 40		ppm/ $^{\circ}\text{C}$
Output Impedance			70		Ω

ADIS16250/ADIS16255

Parameter	Conditions	Min	Typ	Max	Unit
DAC OUTPUT	5 k Ω /100 pF to GND				
Resolution			12		Bits
Relative Accuracy	For Code 101 to Code 4095		4		LSB
Differential Nonlinearity			1		LSB
Offset Error			± 5		mV
Gain Error			± 0.5		%
Output Range			0 to 2.5		V
Output Impedance			2		Ω
Output Settling Time			10		μ s
LOGIC INPUTS	Internal 3.3 V Interface				
Input High Voltage, V_{INH}		2.0			V
Input Low Voltage, V_{INL}				0.8	V
	For \overline{CS} signal when used to wake up from sleep mode			0.55	V
Logic 1 Input Current, I_{INH}	$V_{IH} = 3.3$ V		± 0.2	± 10	μ A
Logic 0 Input Current, I_{INL}	$V_{IL} = 0$ V				
All except \overline{RST}			-40	-60	μ A
\overline{RST} ³			-1		mA
Input Capacitance, C_{IN}			10		pF
DIGITAL OUTPUTS	Internal 3.3 V Interface				
Output High Voltage, V_{OH}	$I_{SOURCE} = 1.6$ mA	2.4			V
Output Low Voltage, V_{OL}	$I_{SINK} = 1.6$ mA			0.4	V
SLEEP TIMER					
Timeout Period ⁴		0.5		128	sec
START-UP TIME					
Initial			160		ms
Sleep Mode Recovery			2.5		ms
FLASH MEMORY					
Endurance ⁵		10,000			Cycles
Data Retention ⁶	$T_J = 55^\circ\text{C}$	20			Years
CONVERSION RATE					
Minimum Conversion Time			3.906		ms
Maximum Conversion Time			7.75		sec
Maximum Throughput Rate			256		SPS
Minimum Throughput Rate			0.129		SPS
POWER SUPPLY					
Operating Voltage Range, V_{CC}		4.75	5.0	5.25	V
Power Supply Current	Normal mode at 25 $^\circ\text{C}$		18		mA
	Fast mode at 25 $^\circ\text{C}$		44		mA
	Sleep mode at 25 $^\circ\text{C}$		425		μ A

¹ ADIS16255 characterization data represents $\pm 4\sigma$ to fall within the $\pm 1\%$ limit.

² The sensor is capable of $\pm 600^\circ/\text{sec}$, but the specifications herein are for $\pm 320^\circ/\text{sec}$ only.

³ The \overline{RST} pin has an internal pull-up.

⁴ Guaranteed by design.

⁵ Endurance is qualified as per JEDEC Standard 22 Method A117 and measured at -40 $^\circ\text{C}$, +25 $^\circ\text{C}$, +85 $^\circ\text{C}$, and +125 $^\circ\text{C}$.

⁶ Retention lifetime equivalent at junction temperature (T_J) 55 $^\circ\text{C}$, as per JEDEC Standard 22 Method A117. Retention lifetime decreases with junction temperature.

TIMING SPECIFICATIONS

T_A = -40°C to +85°C, V_{CC} = 5.0 V, unless otherwise noted.

Table 2.

Parameter	Description	Min ¹	Typ	Max ¹	Unit
f _{SCLK}	Fast mode, SMPL_PRD ≤ 0x07 (f _s ≥ 64 Hz) Normal mode, SMPL_PRD ≥ 0x08 (f _s ≤ 56.9 Hz)	0.01		2.5	MHz
t _{DATARATE}	Data rate period, fast mode, SMPL_PRD ≤ 0x07 (f _s ≥ 64 Hz) Data rate period, normal mode, SMPL_PRD ≥ 0x08 (f _s ≤ 56.9 Hz)	32		42	μs
t _{STALL}	Stall period, fast mode, SMPL_PRD ≤ 0x07 (f _s ≥ 64 Hz) Stall period, normal mode, SMPL_PRD ≥ 0x08 (f _s ≤ 56.9 Hz)	9		12	μs
t _{CS}	Chip select to clock edge	48.8			ns
t _{DAV}	Data output valid after SCLK falling edge ²			100	ns
t _{DSU}	Data input setup time before SCLK rising edge	24.4			ns
t _{DHD}	Data input hold time after SCLK rising edge	48.8			ns
t _{DF}	Data output fall time		5	12.5	ns
t _{DR}	Data output rise time		5	12.5	ns
t _{SFS}	\overline{CS} high after SCLK edge ³	5			ns
	Flash update time (power supply must be within range)	50			ms

¹ Guaranteed by design; not production tested.

² The MSB presents an exception to this parameter. The MSB clocks out on the falling edge of \overline{CS} . The rest of the DOUT bits are clocked after the falling edge of SCLK and are governed by this specification.

³ This parameter may need to be expanded to allow for proper capture of the LSB. After \overline{CS} goes high, the DOUT line goes into a high impedance state.

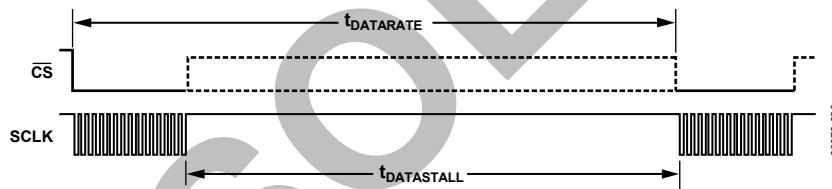

Figure 2. SPI Chip Select Timing

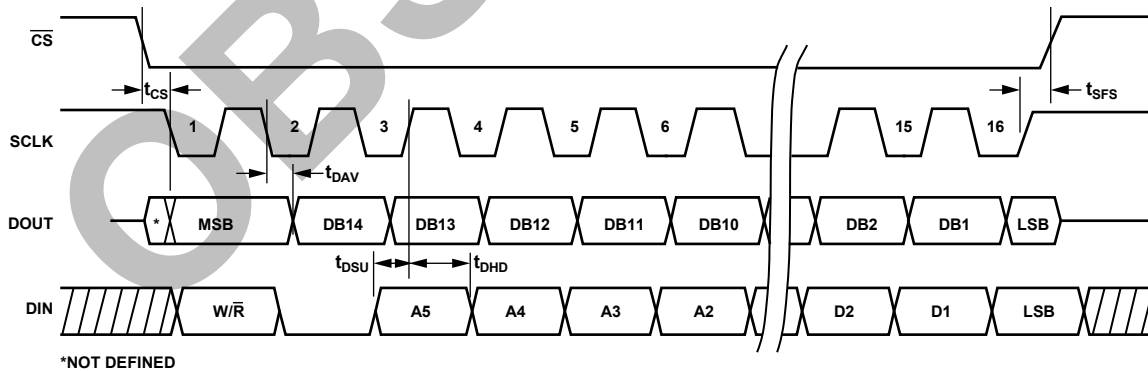

Figure 3. SPI Timing (Using SPI Settings Typically Identified as Phase = 1, Polarity = 1)

ADIS16250/ADIS16255

ABSOLUTE MAXIMUM RATINGS

Table 3.

Parameter	Rating
Acceleration (Any Axis, Unpowered, 0.5 ms)	2000 g
Acceleration (Any Axis, Powered, 0.5 ms)	2000 g
V _{CC} to COM	-0.3 V to +6.0 V
Digital Input/Output Voltage to COM	-0.3 V to +5.5 V
Analog Inputs to COM	-0.3 V to +3.5 V
Operating Temperature Range ¹	-40°C to +125°C
Storage Temperature Range ¹	-65°C to +150°C

¹ Extended exposure to temperatures outside of the specified temperature range of -40°C to +85°C can adversely affect the accuracy of the factory calibration. For best accuracy, store the parts within the specified operating range of -40°C to +85°C.

Stresses above those listed under Absolute Maximum Ratings may cause permanent damage to the device. This is a stress rating only; functional operation of the device at these or any other conditions above those indicated in the operational section of this specification is not implied. Exposure to absolute maximum rating conditions for extended periods may affect device reliability.

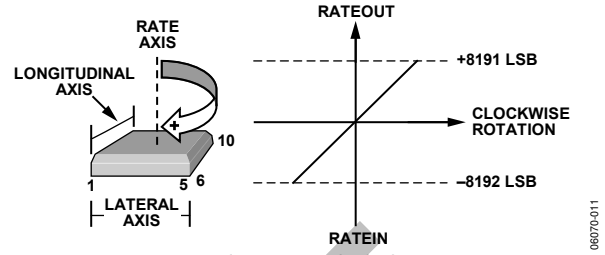

Figure 4. RATEOUT Level Increase with Clockwise Rotation Increase

ESD CAUTION



ESD (electrostatic discharge) sensitive device. Charged devices and circuit boards can discharge without detection. Although this product features patented or proprietary protection circuitry, damage may occur on devices subjected to high energy ESD. Therefore, proper ESD precautions should be taken to avoid performance degradation or loss of functionality.

OBSOLETE

PIN CONFIGURATION AND FUNCTION DESCRIPTIONS

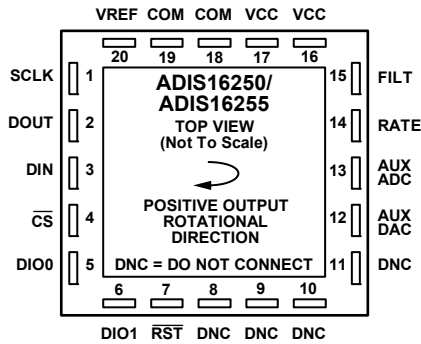

Figure 5. Pin Configuration

Table 4. Pin Function Descriptions

Pin No.	Mnemonic	Type ¹	Description
1	SCLK	I	SPI, Serial Clock.
2	DOUT	O	SPI, Data Output.
3	DIN	I	SPI, Data Input.
4	\overline{CS}	I	SPI, Chip Select, Active Low.
5, 6	DIO0, DIO1	I/O	Multifunction Digital Input/Output Pin.
7	\overline{RST}	I	Reset, Active Low. This resets the sensor signal conditioning circuit and initiates a start-up sequence.
8, 9, 10, 11	DNC	–	Do Not Connect.
12	AUX DAC	O	Auxiliary DAC Analog Output Voltage.
13	AUX ADC	I	Auxiliary ADC Analog Input Voltage.
14	RATE	O	Analog Rate Signal Output (Uncalibrated).
15	FILT	I	Analog Amplifier Summing Junction. This is used for setting the analog bandwidth. See the Analog Bandwidth section for more details.
16, 17	VCC	S	5.0 V Power Supply.
18, 19	COM	S	Common. Reference point for all circuitry in the ADIS16250/ADIS16255.
20	VREF	O	Precision Reference Output.

¹ S = supply; O = output; I = input.

RECOMMENDED LAYOUT

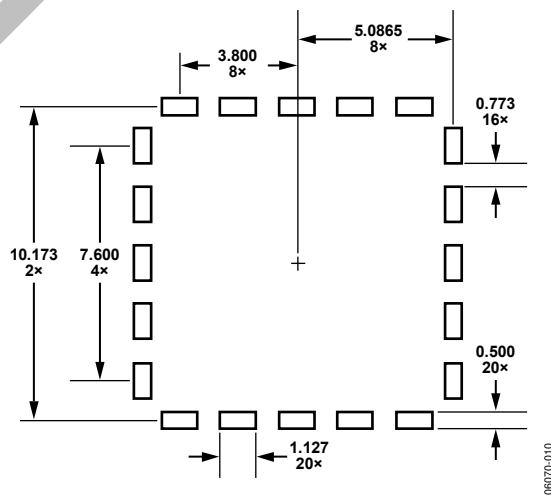

11mm x 11mm STACKED LGA PACKAGE

Figure 6. Recommended Pad Layout (Units in Millimeters)

TYPICAL PERFORMANCE CHARACTERISTICS

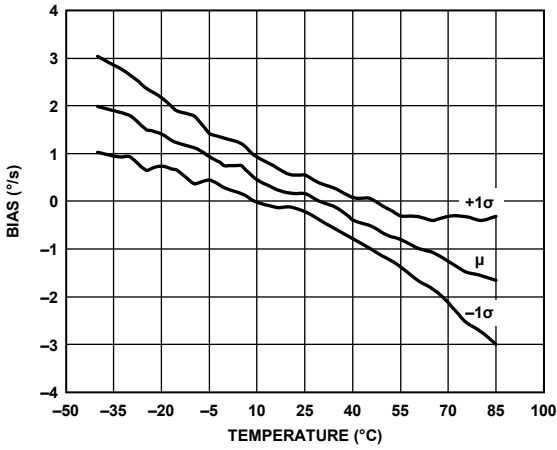

Figure 7. Bias vs. Temperature, ADIS16250

06070-012

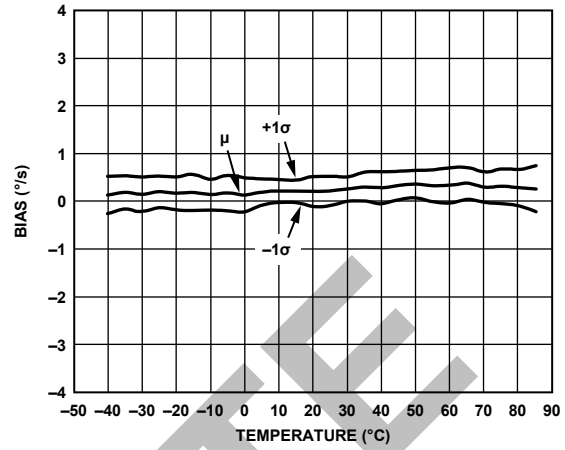

Figure 10. Bias vs. Temperature, ADIS16255

06070-024

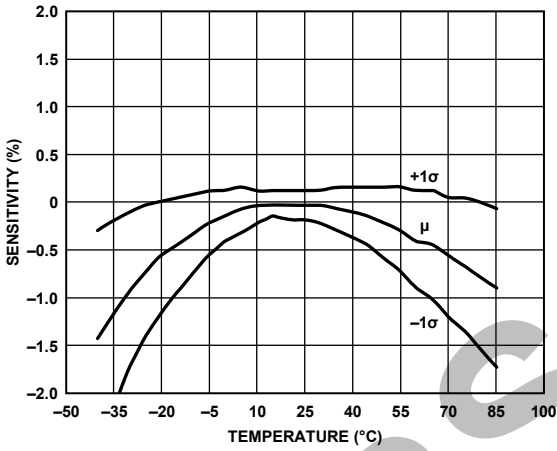

Figure 8. Sensitivity vs. Temperature, ADIS16250

06070-018

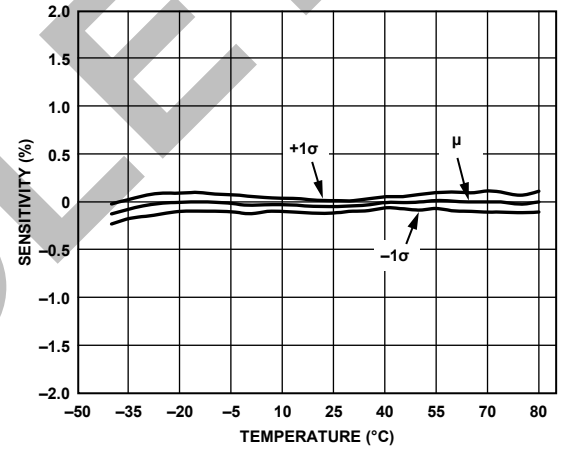

Figure 11. Sensitivity vs. Temperature, ADIS16255

06070-025

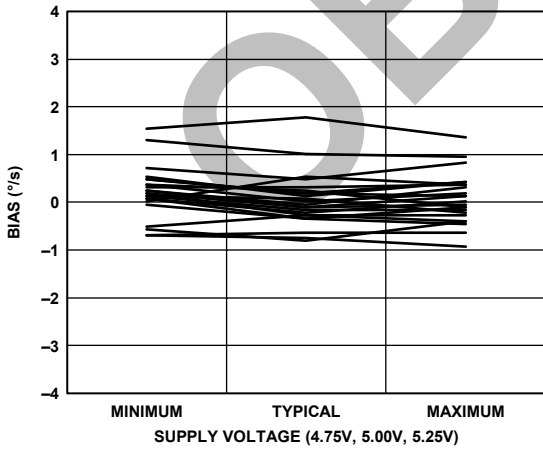

Figure 9. Bias vs. Supply Voltage

06070-013

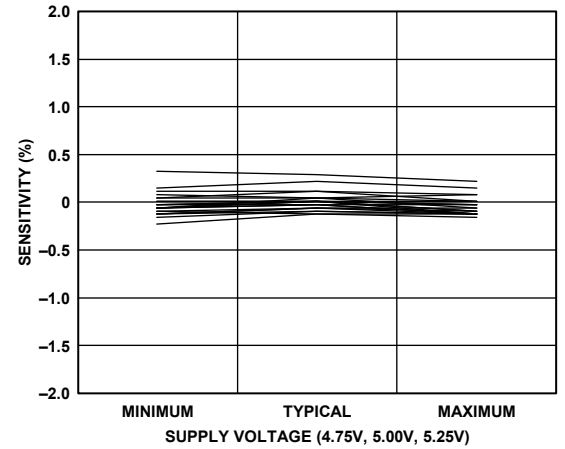

Figure 12. Sensitivity vs. Supply Voltage

06070-017

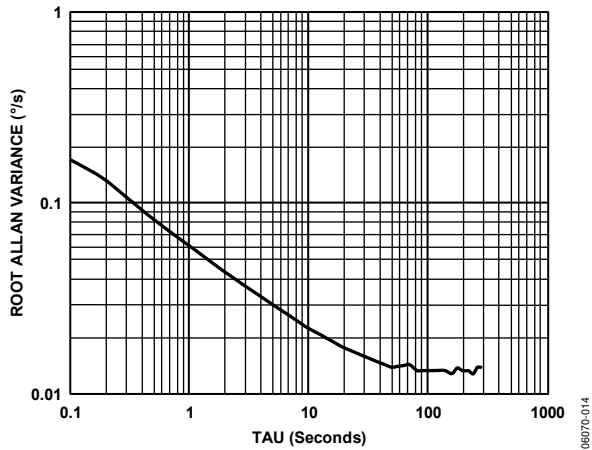

Figure 13. Root Allan Variance vs. TAU, $\pm 320^\circ/\text{sec}$ Range

06070-014

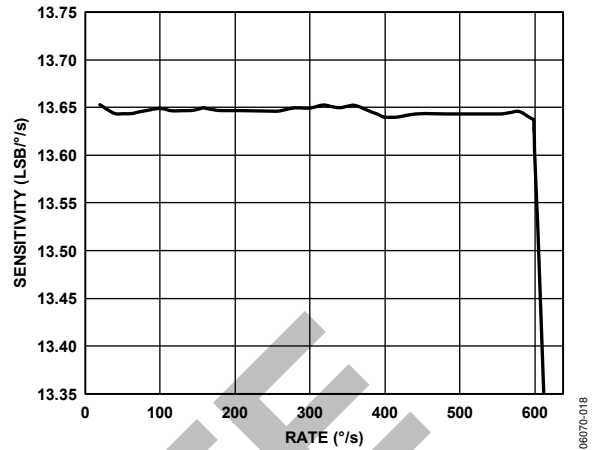

Figure 16. Sensitivity vs. Angular Rate, $\pm 320^\circ/\text{sec}$ Range

06070-018

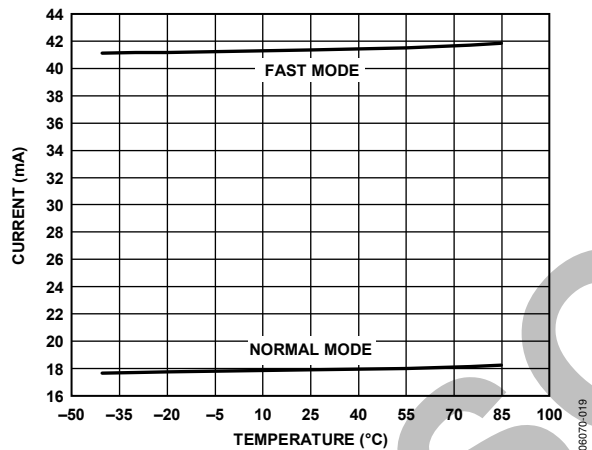

Figure 14. Current vs. Temperature

06070-019

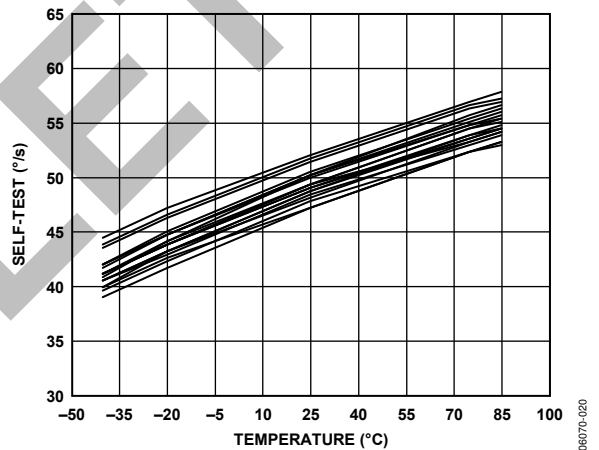

Figure 17. Positive Self-Test vs. Temperature

06070-020

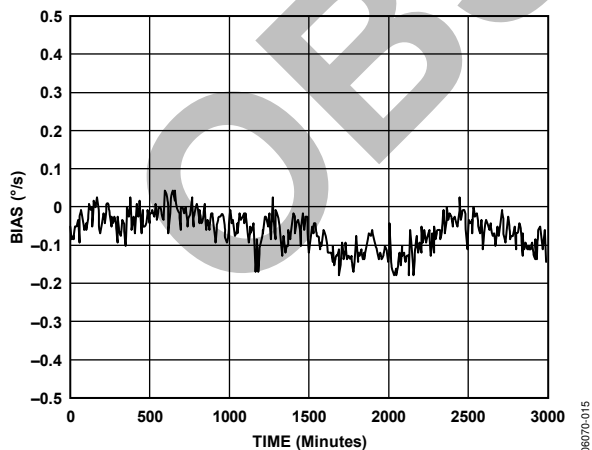

Figure 15. Bias vs. Time

06070-015

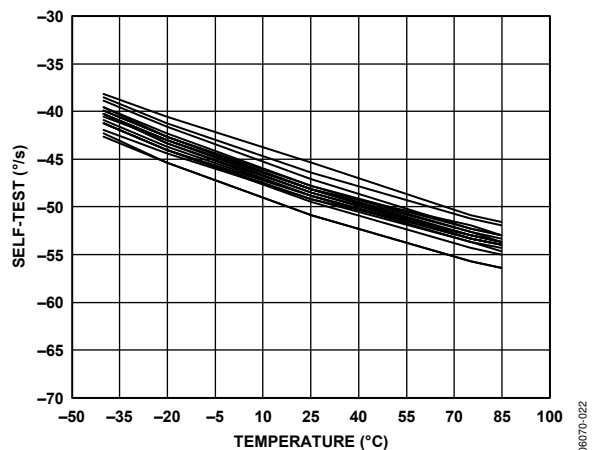

Figure 18. Negative Self-Test vs. Temperature

06070-022

THEORY OF OPERATION

OVERVIEW

The core angular rate sensor integrated inside the ADIS16250/ADIS16255 is based on the Analog Devices *i*MEMS technology. This sensor operates on the principle of a resonator gyroscope. Two polysilicon sensing structures each contain a dither frame electrostatically driven to resonance. This provides the necessary velocity element to produce a Coriolis force during rotation. At two of the outer extremes of each frame, orthogonal to the dither motion, are movable fingers placed between fixed fingers to form a capacitive pickoff structure that senses Coriolis motion. The resulting signal is fed to a series of gain and demodulation stages that produce the electrical rate signal output.

The base sensor output signal is sampled using an ADC, and then the digital data is fed into a proprietary digital calibration circuit. This circuit contains calibration coefficients from the factory calibration, along with user-defined calibration registers that can be used to calibrate system-level errors.

The calibrated gyroscope data (GYRO_OUT) is made available through output data registers along with temperature, power supply, auxiliary ADC, and relative angle output calculations.

RELATIVE ANGLE ESTIMATE

The ANGL_OUT register offers the integration of the GYRO_OUT data. In order for this information to be useful, the reference angle must be known. This can be accomplished by reading the register contents at the initial time, before starting the monitoring, or by setting its contents to zero. This number is reset to zero when the NULL command is used, after a RESET command is used, and during power-up. This function can be used to estimate change in angle over a period. The user is cautioned to fully understand the stability requirements and the time period over which to use this estimated relative angle position.

FACTORY CALIBRATION

The ADIS16250/ADIS16255 provide a factory calibration that includes correction for initial tolerance and power supply variation. In addition, the ADIS16255 provides correction for temperature variation. This calibration includes individual sensor characterization and custom correction coefficient calculation.

AUXILIARY ADC FUNCTION

The auxiliary ADC function integrates a standard 12-bit ADC into the ADIS16250/ADIS16255 to digitize other system-level analog signals. The output of the ADC can be monitored through the AUX_ADC control register, as defined in Table 6. The ADC is a 12-bit successive approximation converter. The output data is presented in straight binary format with the full-scale range extending from 0 V to 2.5 V. The 2.5 V upper limit is derived from the on-chip precision internal reference.

Figure 19 shows the equivalent circuit of the analog input structure of the ADC. The input capacitor (C1) is typically 4 pF and can be attributed to parasitic package capacitance. The two diodes provide ESD protection for the analog input. Care must be taken to ensure that the analog input signals never exceed the range of -0.3 V to +3.5 V. This causes the diodes to become forward-biased and to start conducting. The diodes can handle 10 mA without causing irreversible damage. The resistor is a lumped component that represents the on resistance of the switches. The value of this resistance is typically 100 Ω . Capacitor C2 represents the ADC sampling capacitor and is typically 16 pF.

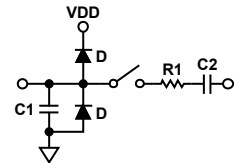

Figure 19. Equivalent Analog Input Circuit
Conversion Phase: Switch Open
Track Phase: Switch Closed

For ac applications, it is recommended to remove high frequency components from the analog input signal by using a low-pass filter on the analog input pin.

In applications where harmonic distortion and signal-to-noise ratio are critical, the analog input must be driven from a low impedance source. Large source impedances significantly affect the ac performance of the ADC. This can necessitate the use of an input buffer amplifier. When no input amplifier is used to drive the analog input, the source impedance should be limited to values lower than 1 k Ω .

BASIC OPERATION

The ADIS16250/ADIS16255 are designed for simple integration into industrial system designs, requiring only a 5.0 V power supply and a 4-wire, industry standard serial peripheral interface (SPI). All outputs and user-programmable functions are handled by a simple register structure. Each register is 16 bits in length and has its own unique bit map. The 16 bits in each register consist of an upper (D8 to D15) byte and a lower (D0 to D7) byte, each of which has its own 6-bit address.

SERIAL PERIPHERAL INTERFACE (SPI)

The ADIS16250/ADIS16255 serial peripheral interface (SPI) port includes four signals: chip select (\overline{CS}), serial clock (SCLK), data input (DIN), and data output (DOUT). The \overline{CS} line enables the ADIS16250/ADIS16255 SPI port and frames each SPI event, which consists of single or multiple data frames. When this signal is high, the DOUT lines are in a high impedance state and the signals on DIN and SCLK have no impact on operation. A complete data frame contains 16 clock cycles. Because the SPI port operates in full duplex mode, it supports simultaneous, 16-bit receive (DIN) and transmit (DOUT) functions during the same data frame.

Refer to Table 2, Figure 2, and Figure 3 for detailed timing and operation of the SPI port.

Writing to Registers

Figure 20 displays a typical data frame for writing a command to a control register. In this case, the first bit of the DIN sequence is a 1, followed by a 0, the 6-bit address, and the 8-bit data command. Because each write command covers a single byte of data, two data frames are required when writing the entire 16-bit space of a register.

Reading from Registers

Reading the contents of a register requires a modification to the sequence in Figure 20. In this case, the first two bits in the DIN sequence are 0, followed by the address of the register. Each register has two addresses (upper, lower), but either one can be used to access its entire 16 bits of data. The final eight bits of the DIN sequence are irrelevant and can be counted as don't cares during a read command. During the next data frame, the DOUT sequence contains the register's 16-bit data, as shown in Figure 21. Although a single read command requires two separate data frames, the full duplex mode minimizes this overhead, requiring only one extra data frame when continuously sampling.

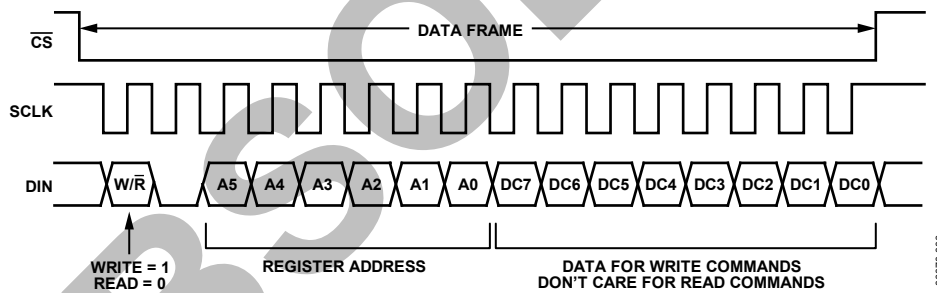

Figure 20. DIN Bit Sequence

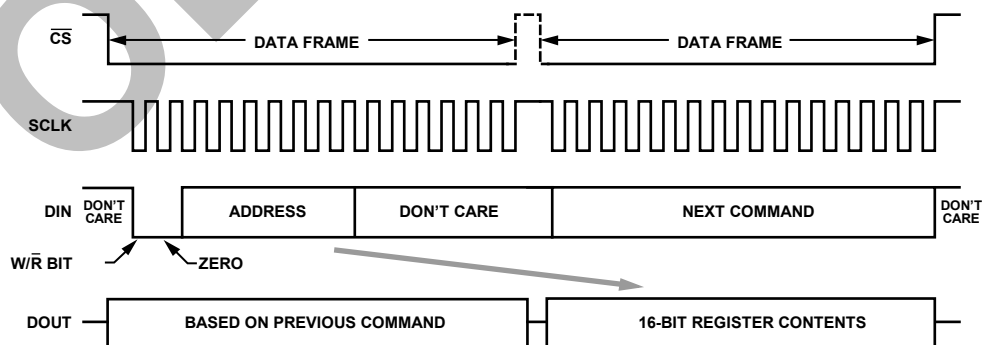

Figure 21. SPI Sequence for Read Commands

ADIS16250/ADIS16255

DATA OUTPUT REGISTER ACCESS

The ADIS16250/ADIS16255 provide access to calibrated rotation measurements, relative angle estimates, power supply measurements, temperature measurements, and an auxiliary 12-bit ADC channel. This output data is continuously updating internally, regardless of user read rates. The following bit map describes the structure of all output data registers, except ENDURANCE, in the ADIS16250/ADIS16255.

Table 5. Register Bit Map

MSB				LSB			
ND	EA	D13	D12	D11	D10	D9	D8
D7	D6	D5	D4	D3	D2	D1	D0

The MSB holds the new data (ND) indicator. When the output registers are updated with new data, the ND bit goes to a 1 state. After the output data is read, it returns to a 0 state. The EA bit is used to indicate a system error or an alarm condition that can result from a number of conditions, such as a power supply that is out of the specified operating range. See the Status and Diagnostics section for more details. The output data is either 12 bits or 14 bits in length. For all of the 12-bit output data, Bit D13 and Bit D12 are assigned don't care status.

The output data register map is located in Table 6 and provides all of the necessary details for accessing each register's data. Table 7 displays the output coding for the GYRO_OUT register. Figure 22 provides an example SPI read cycle for this register.

Table 6. Data Output Register Information

Name	Function	Address	Resolution (Bits)	Data Format	Scale Factor (per LSB)
ENDURANCE	Flash Memory Write Counter	0x01, 0x00	16	Binary	1 count
SUPPLY_OUT	Power Supply Data	0x03, 0x02	12	Binary	1.8315 mV
GYRO_OUT	Gyroscope Data	0x05, 0x04	14	Twos Complement	0.07326°/sec ¹
AUX_ADC	Auxiliary Analog Input Data	0x0B, 0x0A	12	Binary	0.6105 mV
TEMP_OUT	Sensor Temperature Data	0x0D, 0x0C	12	Twos Complement	0.1453°C
ANGL_OUT	Angle Output	0x0F, 0x0E	14	Binary	0.03663°

¹ Assumes that the scaling is set to 320°/sec.

Table 7. Output Coding Example, GYRO_OUT^{1, 2}

Rate of Rotation			Binary Output	Hex Output	Decimal
±320°/sec Range	±160°/sec Range	±80°/sec Range			
600°/sec	300°/sec	150°/sec	01 1111 1111 1111	0x1FFF	8191
320°/sec	160°/sec	80°/sec	01 0001 0001 0000	0x1110	4368
80°/sec	40°/sec	20°/sec	00 0100 0100 0100	0x0444	1092
40°/sec	20°/sec	10°/sec	00 0010 0010 0010	0x0222	546
0.07326°/sec	0.03663°/sec	0.018315°/sec	00 0000 0000 0001	0x0001	1
0°/sec	0°/sec	0°/sec	00 0000 0000 0000	0x0000	0
-0.07326°/sec	-0.03663°/sec	-0.018315°/sec	11 1111 1111 1111	0x3FFF	-1
-40°/sec	-20°/sec	-10°/sec	11 1101 1101 1110	0x3DDE	-546
-80°/sec	-40°/sec	-20°/sec	11 1011 1011 1100	0x3BBC	-1092
-320°/sec	-160°/sec	-80°/sec	10 1110 1111 0000	0x2EFO	-4368
-600°/sec	-300°/sec	-150°/sec	10 0000 0000 0000	0x2000	-8192

¹ Two MSBs have been masked off and are not considered in the coding.

² Nominal sensitivity and zero offset null performance are assumed.

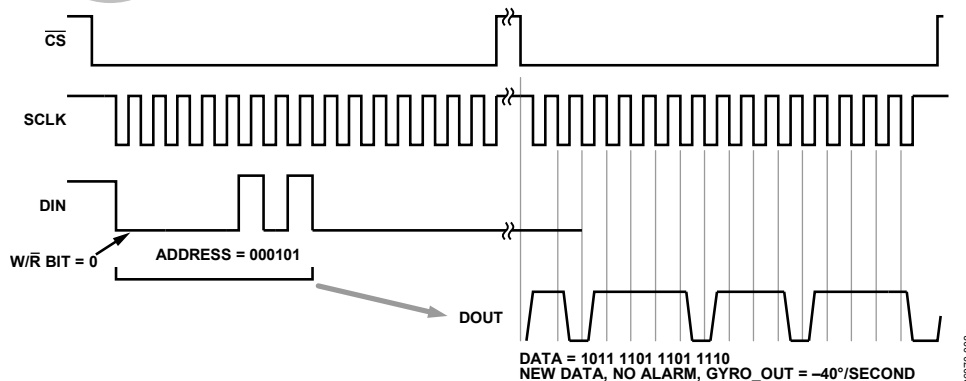

Figure 22. Example Read Cycle, ±320°/sec Setting

PROGRAMMING AND CONTROL

CONTROL REGISTER OVERVIEW

The ADIS16250/ADIS16255 offer many programmable features controlled by writing commands to the appropriate control registers using the SPI. Table 8 provides a summary of these control registers, which controls the operation of the following parameters:

- Calibration
- Global commands
- Operational control
 - Sample rate
 - Power management
 - Digital filtering
 - Dynamic range
 - DAC output
 - Digital I/O
- Operational status and diagnostics
 - Self-test
 - Status conditions
 - Alarms

CONTROL REGISTER STRUCTURE

The ADIS16250/ADIS16255 uses a temporary, RAM-based memory structure to facilitate the control registers displayed in Table 8. The start-up configuration is stored in a flash memory structure that automatically loads into the control registers during the start-up sequence. Each nonvolatile register has a corresponding flash memory location, for storing the latest configuration contents. Since flash memory has endurance limitations, the contents of each nonvolatile register must be manually stored to flash (note that the contents of the control register contents are only nonvolatile when they are stored to flash). The manual flash update command, made available in the COMMAND register, provides this function. The ENDURANCE register provides a counter that allows for memory reliability management against the write cycle specification.

Table 8. Control Register Memory Map

Register Name	Type	Volatility	Address	Bytes	Function	Reference Table
GYRO_OFF	R/W	Nonvolatile	0x15, 0x14	2	Gyroscope bias offset factor	Table 9, Table 10
GYRO_SCALE	R/W	Nonvolatile	0x17, 0x16 0x18 to 0x1F	2 8	Gyroscope scale factor Reserved	Table 11, Table 12
ALM_MAG1	R/W	Nonvolatile	0x21, 0x20	2	Alarm 1 amplitude threshold and polarity	Table 31, Table 32
ALM_MAG2	R/W	Nonvolatile	0x23, 0x22	2	Alarm 2 amplitude threshold and polarity	Table 35, Table 36
ALM_SMPL1	R/W	Nonvolatile	0x25, 0x24	2	Alarm 1 sample period	Table 33, Table 34
ALM_SMPL2	R/W	Nonvolatile	0x27, 0x26	2	Alarm 2 sample period	Table 37, Table 38
ALM_CTRL	R/W	Nonvolatile	0x29, 0x28 0x2A to 0x2F	2 6	Alarm control register Reserved	Table 39, Table 40
AUX_DAC	R/W	Volatile	0x31, 0x30	2	Auxiliary DAC data	Table 21, Table 22
GPIO_CTRL	R/W	Volatile	0x33, 0x32	2	Auxiliary digital I/O control register	Table 23, Table 24
MSC_CTRL	R/W	Nonvolatile ¹	0x35, 0x34	2	Miscellaneous control register	Table 26, Table 27
SMPL_PRD	R/W	Nonvolatile	0x37, 0x36	2	ADC sample period control	Table 15, Table 16
SENS/AVG	R/W	Nonvolatile	0x39, 0x38	2	Defines the dynamic range (sensitivity setting) and the number of taps for the digital filter	Table 19, Table 20
SLP_CNT	R/W	Volatile	0x3B, 0x3A	2	Counter used to determine length of power-down mode	Table 17, Table 18
STATUS	R	Volatile	0x3D, 0x3C	2	System status register	Table 28, Table 29
COMMAND	W	N/A	0x3F, 0x3E	2	System command register	Table 13, Table 14

¹ The contents of the upper byte are nonvolatile; the contents of the lower byte are volatile.

ADIS16250/ADIS16255

CALIBRATION

The ADIS16250/ADIS16255 are factory-calibrated for sensitivity and bias. It also provides several user calibration functions for simplifying field-level corrections. The calibration factors are stored in nonvolatile memory and are applied using the following linear calibration equation:

$$y = mx + b$$

where:

y is the calibrated output data.

x is the precalibration data.

m is the sensitivity scale factor.

b is the offset scale factor.

There are three options for system-level calibrations of the bias in the ADIS16250/ADIS16255: auto-null, factory calibration restore, and manual calibration updates. The auto-null and factory reset options are described in the Global Commands section. Optional field-level calibrations use the preceding equation and require two steps:

1. Characterize the behavior of the ADIS16250/ADIS16255 at predefined critical operating conditions.
2. Use this characterization data to calculate and load the contents of GYRO_OFF (b) and GYRO_SCALE (m).

The GYRO_OFF provides a calibration range of $\pm 37.5^\circ/\text{sec}$, and its contents are nonvolatile. The GYRO_SCALE register provides a calibration range of 0 to 1.9995, and its contents are also nonvolatile.

Table 9. GYRO_OFF Register Definition

Address	Scale ¹	Default	Format	Access
0x15, 0x14	0.018315°/sec	0x0000	Twos complement	R/W

¹ Scale is the weight of each LSB.

Table 10. GYRO_OFF Bit Descriptions

Bit	Description
15:12	Not used
11:0	Data bits

Table 11. GYRO_SCALE Register Definition

Address	Scale ¹	Default ²	Format	Access
0x17, 0x16	0.0487%	0x0800	Binary	R/W

¹ Scale is the weight of each LSB.

² Equates to a scale factor of one.

Table 12. GYRO_SCALE Bit Descriptions

Bit	Description
15:12	Not used
11:0	Data bits

GLOBAL COMMANDS

The ADIS16250/ADIS16255 provide global commands for common operations such as auto-null, factory calibration restore, manual flash update, auxiliary DAC latch, and software reset. Each of these global commands has a unique control bit assigned to it in the COMMAND register and is initiated by writing a 1 to its assigned bit.

The auto-null function does two things: it resets the contents of the ANGL_OUT register to zero, and it adjusts the GYRO_OUT register to zero. This automated adjustment takes two steps:

1. Read GYRO_OUT.
2. Write the opposite of this value into the GYRO_OFF register. Sensor noise influences the accuracy of this step.

For optimal calibration accuracy, set the number of filtering taps to its maximum, wait for the appropriate number of samples to process through the filter, and then exercise this option.

The factory calibration restore command sets the contents of GYRO_OFF to 0x0000 and GYRO_SCALE to 0x0800, erasing any field-level calibration contents. The manual flash update writes the contents of each nonvolatile register into flash memory for storage. This process takes approximately 50 ms and requires the power supply voltage to be within specification for the duration of the event. It is worth noting that this operation also automatically follows the auto-null and factory reset commands.

The DAC latch command loads the contents of AUX_DAC into the DAC latches. Since the AUX_DAC contents must be updated one byte at a time, this command ensures a stable DAC output voltage during updates. Finally, the software reset command sends the ADIS16250/ADIS16255 digital processor into a restart sequence, effectively doing the same thing as the $\overline{\text{RST}}$ line.

Table 13. COMMAND Register Definition

Address	Default	Format	Access
0x3F, 0x3E	N/A	N/A	Write only

Table 14. COMMAND Bit Descriptions

Bit	Description
15:8	Not used
7	Software reset command
6:4	Not used
3	Manual flash update command
2	Auxiliary DAC data latch
1	Factory calibration restore command
0	Auto-null command

OPERATIONAL CONTROL

Internal Sample Rate

The internal sample rate defines how often data output variables are updated, independent of the rate at which they are read out on the SPI port. The SMPL_PRD register controls the ADIS16250/ADIS16255 internal sample rate and has two parts: a selectable time base and a multiplier. The sample period can be calculated using the following equation:

$$T_S = T_B \times (N_S + 1)$$

where:

T_S is the sample period.

T_B is the time base.

N_S is the increment setting.

The default value is the maximum 256 samples per second, and the contents of this register are nonvolatile.

Table 15. SMPL_PRD Register Definition

Address	Default	Format	Access
0x37, 0x36	0x0001	N/A	R/W

Table 16. SMPL_PRD Bit Descriptions

Bit	Description
15:8	Not used
7	Time base, 0 = 1.953 ms, 1 = 60.54 ms
6:0	Multiplier

The following is an example calculation of the sample period for the ADIS16250/ADIS16255:

If $SMPL_PRD = 0x0007$, $B7...B0 = 00000111$

$B7 = 0 \rightarrow T_B = 1.953 \text{ ms}$

$B6...B0 = 000000111 \rightarrow N_S = 7$

$T_S = T_B \times (N_S + 1) = 1.953 \text{ ms} \times (7 + 1) = 15.624 \text{ ms}$

$f_S = 1/T_S = 64 \text{ SPS}$

The sample rate setting has a direct impact on the SPI data rate capability. For sample rates of 64 SPS and above, the SPI SCLK can run at a rate up to 2.5 MHz. For sample rates below 64 SPS, the SPI SCLK can run at a rate up to 1 MHz.

The sample rate setting also affects the power dissipation. When the sample rate is set below 64 SPS, the power dissipation reduces by a factor of 60%. The two different modes of operation offer a system-level trade-off between performance (sample rate, serial transfer rate) and power dissipation.

Power Management

In addition to offering two different performance modes for power optimization, the ADIS16250/ADIS16255 offer a programmable shutdown period. Writing the appropriate sleep time to the SLP_CNT register shuts the device down for the specified time. The following example provides an illustration of this relationship:

$B7 \dots B0 = 00000110$

Sleep period = 3 sec

After completing the sleep period, the ADIS16250/ADIS16255 return to normal operation. If measurements are required before sleep period completion, the ADIS16250/ADIS16255 can be awakened by putting the \overline{CS} line in a zero logic state. Otherwise, the \overline{CS} line must be kept high to maintain sleep mode.

Table 17. SLP_CNT Register Definition

Address	Scale ¹	Default	Format	Access
0x3B, 0x3A	0.5 sec	0x0000	Binary	R/W

¹ Scale is the weight of each LSB.

Table 18. SLP_CNT Bit Descriptions

Bit	Description
15:8	Not used
7:0	Data bits

Analog Bandwidth

The analog bandwidth of the ADIS16250/ADIS16255 is 50 Hz. This bandwidth can be reduced by placing an external capacitor across the RATE and FILT pins. In this case, the analog bandwidth can be calculated using the following equation:

$$f_{OUT} = 1/(2 \times \pi \times R_{OUT} \times (C_{OUT} + 0.068 \mu\text{F}))$$

where:

$R_{OUT} = 45.22 \text{ k}\Omega$.

C_{OUT} is the external capacitance.

Digital Filtering

The ADIS16250/ADIS16255 GYRO_OUT signal path has a nominal analog bandwidth of 50 Hz. The ADIS16250 provides a Bartlett Window FIR filter for additional noise reduction on all of the output data registers. The SENS/AVG register stores the number of taps in this filter in seven power-of-two step sizes (that is, $2^M = 1, 2, 4, 16, 32, 64,$ and 128). Filter setup requires one simple step: write the appropriate M factor to the assigned bits in the SENS/AVG register. The bit assignments are listed in Table 20. The following equation offers a frequency response relationship for this filter:

$$H_B(f) = H_A^2(f) \Rightarrow H_A(f) = \frac{\sin(\pi \times N \times f \times t_s)}{N \times \sin(\pi \times f \times t_s)}$$

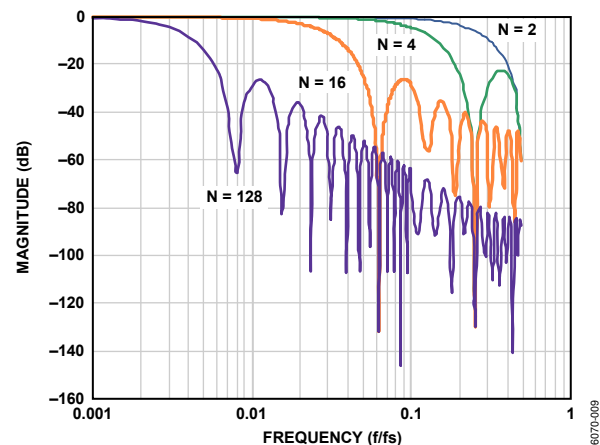

Figure 23. Bartlett Window FIR Frequency Response

ADIS16250/ADIS16255

Dynamic Range

The ADIS16250/ADIS16255 provide three dynamic range settings: $\pm 80^\circ/\text{sec}$, $\pm 160^\circ/\text{sec}$, and $\pm 320^\circ/\text{sec}$. The lower dynamic range settings (80, 160) limit the minimum filter tap sizes in order to maintain the resolution as the maximum rate measurements decrease. The recommended order for programming the SENS/AVG register is (1) dynamic range and then (2) filtering response. The contents of the SENS/AVG register are nonvolatile.

Table 19. SENS/AVG Register Definition

Address	Default	Format	Access
0x39, 0x38	0x0402	Binary	R/W

Table 20. SENS/AVG Bit Descriptions

Bit	Value	Description
15:11		Not used
10:8		Sensitivity selection bits
	100	320°/sec (default condition)
	010	160°/sec, filter taps ≥ 4 (Bits[3:0] $\geq 0x02$)
	001	80°/sec, filter taps ≥ 16 (Bits[3:0] $\geq 0x04$)
7:4		Not used
3:0		Filter tap setting, M = binary number (number of taps, $N = 2^M$)

Auxiliary DAC

The auxiliary DAC provides a 12-bit level adjustment function. The AUX_DAC register controls the operation of this feature. It offers a rail-to-rail buffered output that has a range of 0 V to 2.5 V. The DAC can drive its output to within 5 mV of the ground reference when it is not sinking current. As the output approaches ground, the linearity begins to degrade (100 LSB beginning point). As the sink current increases, the nonlinear range increases. The DAC output latch function, contained in the COMMAND register, provides continuous operation while writing each byte of this register. The contents of this register are volatile, which means that the desired output level must be set after every reset and power cycle event.

Table 21. AUX_DAC Register Definition

Address	Default	Format	Access
0x31, 0x30	0x0000	Binary	R/W

Table 22. AUX_DAC Bit Descriptions

Bit	Description
15:12	Not used
11:0	Data bits

General-Purpose I/O

The ADIS16250/ADIS16255 provide two general-purpose pins that enable digital I/O control using the SPI. The GPIO_CTRL control register establishes the configuration of these pins and handles the SPI-to-pin controls. Each pin provides the flexibility of both input (read) and output (write) operations. For example, writing a 0x0202 to this register establishes Line 0 as an output and sets its level as a one. Writing 0x0000 to this register establishes both lines as inputs, and their status can be read through Bit 0 and Bit 1 of this register.

The digital I/O lines are also available for data-ready and alarm/error indications. In the event of conflict, the following priority structure governs the digital I/O configuration:

1. MSC_CTRL
2. ALM_CTRL
3. GPIO_CTRL

Table 23. GPIO_CTRL Register Definition

Address	Default	Format	Access
0x33, 0x32	0x0000	N/A	R/W

Table 24. GPIO_CTRL Bit Descriptions

Bit	Description
15:10	Not used
9	General-purpose I/O Line 1 polarity 1 = high 0 = low
8	General-purpose I/O Line 0 polarity 1 = high 0 = low
7:2	Not used
1	General-purpose I/O Line 1, data direction control 1 = output 0 = input
0	General-purpose I/O Line 0, data direction control 1 = output 0 = input

STATUS AND DIAGNOSTICS

The ADIS16250/ADIS16255 provide a number of status and diagnostic functions. Table 25 provides a summary of these functions, along with their appropriate control registers.

Table 25. Status and Diagnostic Functions

Function	Register
Data-ready I/O indicator	MSC_CTRL
Self-test, mechanical check for MEMS sensor	MSC_CTRL
Status, check for predefined error conditions	STATUS
Flash memory endurance	ENDURANCE
Alarms, configure and check for user-specific conditions	ALM_MAG1/2 ALM_SMPL1/2 ALM_CTRL

Data-Ready I/O Indicator

The data-ready function provides an indication of updated output data. The MSC_CTRL register provides the opportunity to configure either of the general-purpose I/O pins (DIO0 and DIO1) as a data-ready indicator signal. After each output register update, the digital I/O changes states, then returns to its original state, creating a pulsed waveform. The duty cycle of that waveform is in between 15% and 35%.

Table 26. MSC_CTRL Register Definition

Address	Default	Format	Access
0x35, 0x34	0x0000	N/A	R/W

Table 27. MSC_CTRL Bit Descriptions

Bit	Description
15:11	Not used
10	Internal self-test enable 1 = enabled 0 = disabled
9	External negative rotation self-test enable 1 = enabled 0 = disabled
8	External positive rotation self-test enable 1 = enabled 0 = disabled
7:3	Not used
2	Data-ready enable 1 = enabled 0 = disabled
1	Data-ready polarity 1 = active high 0 = active low
0	Data-ready line select 1 = DIO1 0 = DIO0

Self-Test

The MSC_CTRL register also provides a self-test function, which verifies the MEMS sensor’s mechanical integrity. There are two different self-test options: (1) internal self-test and (2) external self-test. The internal test provides a simple, two-step process for checking the MEMS sensor: (1) start the process by writing a 1 to Bit 10 in the MSC_CTRL register and (2) check the result by reading Bit 5 of the STATUS register, after 35 ms.

The external self-test is a static condition that can be enabled and disabled. In this test, both positive and negative MEMS sensor movements are available. After writing to the appropriate control bit, the GYRO_OUT register reflects the changes after a delay that reflects the sensor signal chain response time.

For example, the standard 52 Hz bandwidth reflects an exponential response with a time constant of 3.2 ms. If the bandwidth is reduced externally (capacitor across RATE and FILT) or internally (increasing the number of filter taps, SENS/AVG), this time constant increases. For the internal self-test option, increasing the delay can produce false alarms, since the internal timing for this function is optimized for maximum bandwidth. The appropriate bit definitions for self-test are listed in Table 26 and Table 27.

Status Conditions

The STATUS register contains the following error-condition flags: Alarm conditions, self-test status, angular rate over range, SPI communication failure, control register update failure, and power supply out of range. See Table 28 and Table 29 for the appropriate register access and bit assignment for each flag.

The bits assigned for checking power supply range and angular rate over range automatically reset to 0 when the error condition no longer exists. The remaining error-flag bits in the STATUS register require a read in order to return them to 0. Note that a STATUS register read clears all of the bits to 0.

Table 28. STATUS Register Definition

Address	Default	Format	Access
0x3D, 0x3C	0x0000	N/A	Read-only

Table 29. STATUS Bit Descriptions

Bit	Description
15:10	Not used
9	Alarm 2 status 1 = active 0 = inactive
8	Alarm 1 status 1 = active 0 = inactive
7:6	Not used
5	Self-test diagnostic error flag 1 = error condition 0 = normal operation
4	Angular rate over range 1 = error condition 0 = normal operation
3	SPI communications failure 1 = error condition 0 = normal operation
2	Control register update failed 1 = error condition 0 = normal operation
1	Power supply above 5.25 V 1 = above 5.25 V 0 = below 5.25 V (normal)
0	Power supply below 4.75 V 1 = below 4.75 V 0 = above 4.75 V (normal)

ADIS16250/ADIS16255

Flash Memory Endurance

The ENDURANCE register maintains a running count of writes to the flash memory. It provides up to 32,768 counts. Note that if this count is exceeded, the register wraps around, and goes back to zero, before beginning to increment again.

Table 30. ENDURANCE Register Definition

Address	Default	Format	Access
0x01, 0x00	N/A	Binary	Read-only

Alarms

The ADIS16250/ADIS16255 provide two independent alarm options for event detection. Event detections occur when output register data meets the configured conditions. Configuration options are:

- All output data registers are available for monitoring as the source data.
- The source data can be filtered or unfiltered.
- Comparisons can be static or dynamic (rate of change).
- The threshold levels and times are configurable.
- Comparison can be greater than or less than.

The ALM_MAG1 register and the ALM_MAG2 register both establish the threshold level for detecting events. They take on the format of the source data and provide a bit for establishing the greater than/less than comparison direction. When making dynamic comparisons, the ALM_SMPL1 register and the ALM_SMPL2 register establish the number of averages taken for the source data as a reference for comparison. In this configuration, each subsequent source data sample is subtracted from the previous one, establishing an instantaneous delta. The ALM_CTRL register controls the source data selection, static/dynamic selection, filtering selection, and digital I/O usage for the alarms.

The rate of change calculation is

$$Y_C = \frac{1}{N_{DS}} \sum_{n=1}^{N_{DS}} y(n+1) - y(n)$$

Rate of change alarm \Rightarrow is $Y_C >$ or $<$ M_C ?

where:

N_{DS} is the number of samples in ALM_SMPL1/2.

$y(n)$ is the sampled output data.

M_C is the magnitude for comparison in ALM_MAG1/2.

Y_C is the factor to be compared with M_C .

$>$ or $<$ is determined by the MSB in ALM_MAG1/2.

Table 31. ALM_MAG1 Register Definition

Address	Default	Format	Access
0x21, 0x20	0x0000	N/A	R/W

Table 32. ALM_MAG1 Bit Descriptions

Bit	Description
15	Comparison polarity: 1 = greater than, 0 = less than
14	Not used
13:0	Data bits: format matches source data format

Table 33. ALM_SMPL1 Register Definition

Address	Default	Format	Access
0x25, 0x24	0x0000	Binary	R/W

Table 34. ALM_SMPL1 Bit Descriptions

Bit	Description
15:8	Not used
7:0	Data bits

Table 35. ALM_MAG2 Register Definition

Address	Default	Format	Access
0x23, 0x22	0x0000	N/A	R/W

Table 36. ALM_MAG2 Bit Descriptions

Bit	Description
15	Comparison polarity 1 = greater than 0 = less than
14	Not used
13:0	Data bits: format matches source data format

Table 37. ALM_SMPL2 Register Definition

Address	Default	Format	Access
0x27, 0x26	0x0000	Binary	R/W

Table 38. ALM_SMPL2 Bit Designations

Bit	Description
15:8	Not used
7:0	Data bits

Table 39. ALM_CTRL Register Definition

Address	Default	Format	Access
0x29, 0x28	0x0000	N/A	R/W

Table 40. ALM_CTRL Bit Descriptions

Bit	Value	Description
15		Rate of change (ROC) enable for Alarm 2 1 = rate of change 0 = static level
14:12		Alarm 2 source selection
	000	Disable
	001	Power supply output
	010	Gyroscope output
	011	Inactive
	100	Inactive
	101	Auxiliary ADC output
	110	Temperature sensor output
	111	Inactive
11		Rate of change (ROC) enable for Alarm 1 1 = rate of change 0 = static level
10:8		Alarm 1 source selection
	000	Disable
	001	Power supply output
	010	Gyroscope output
	011	Inactive
	100	Inactive
	101	Auxiliary ADC output
	110	Temperature sensor output
	111	Inactive
7:5		Not used
4		Filtered data comparison 1 = filtered data 0 = unfiltered data
3		Not used
2		Alarm output enable 1 = enabled 0 = disabled
1		Alarm output polarity 1 = active high 0 = active low
0		Alarm output line select 1 = DIO1 0 = DIO0

ADIS16250/ADIS16255

OUTLINE DIMENSIONS

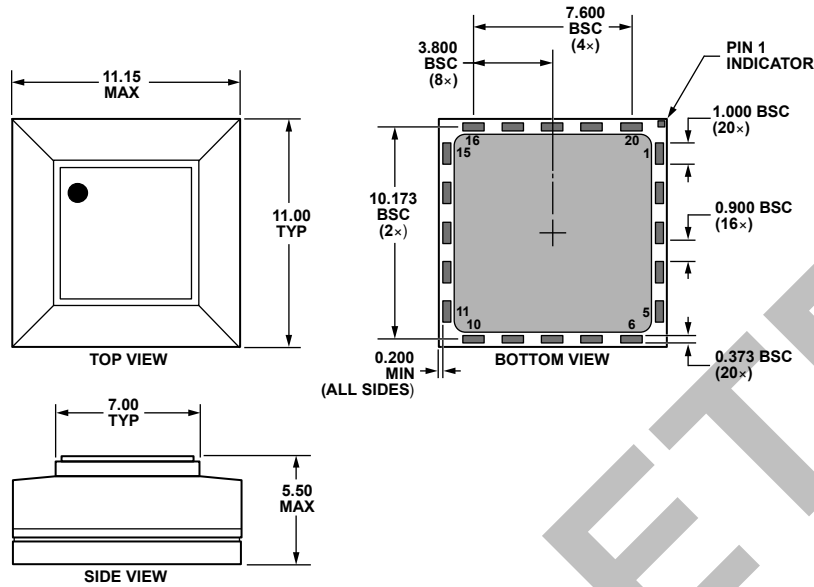

Figure 24. 20-Terminal Stacked Land Grid Array [LGA]
(CC-20-1)

Dimensions shown in millimeters

ORDERING GUIDE

Model	Temperature Range	Package Description	Package Option
ADIS16250ACCZ ¹	-40°C to +85°C	20-Terminal Stacked Land Grid Array [LGA]	CC-20-1
ADIS16255ACCZ ¹	-40°C to +85°C	20-Terminal Stacked Land Grid Array [LGA]	CC-20-1
ADIS16250/PCBZ ¹		Evaluation Board for the ADIS16250	
ADIS16255/PCBZ ¹		Evaluation Board for the ADIS16255	

¹ Z = RoHS Compliant Part.