

**DUAL N-CHANNEL ENHANCEMENT MODE MOSFET**
**Product Summary**

$V_{(BR)DSS}$	$R_{DS(ON)}$	Package	$I_D$ $T_A = +25^\circ\text{C}$
60V	8Ω @ $V_{GS} = 5V$	SOT363	170mA
	6Ω @ $V_{GS} = 10V$		200mA

**Description**

This new generation MOSFET is designed to minimize the on-state resistance ( $R_{DS(ON)}$ ) and yet maintain superior switching performance, making it ideal for high efficiency power management applications.

**Applications**

- DC-DC Converters
- Power Management Functions
- Battery Operated Systems and Solid-State Relays
- Drivers: Relays, Solenoids, Lamps, Hammers, Displays, Memories, Transistors, etc.

**Features**

- Dual N-Channel MOSFET
- Low On-Resistance
- Low Gate Threshold Voltage
- Low Input Capacitance
- Fast Switching Speed
- Small Surface Mount Package
- ESD Protected Gate, 1kV (HBM)
- **Totally Lead-Free & Fully RoHS Compliant (Notes 1 & 2)**
- **Halogen and Antimony Free. "Green" Device (Note 3)**
- **Qualified to AEC-Q101 Standards for High Reliability**
- **PPAP Capable (Note 4)**

**Mechanical Data**

- Case: SOT363
- Case Material: Molded Plastic; UL Flammability Classification Rating 94V-0
- Moisture Sensitivity: Level 1 per J-STD-020
- Terminals: Solderable per MIL-STD-202, Method 208 (e3)
- Lead-Free Plating (Matte Tin Finish Annealed over Alloy 42 Leadframe).
- Terminal Connections: See Diagram
- Weight: 0.006 grams (Approximate)



SOT363

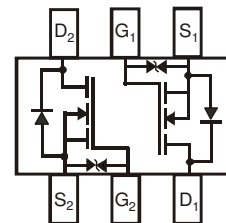

Top View

 Top View  
Internal Schematic

**Ordering Information** (Note 5)

Part Number	Case	Packaging
DMN65D8LDWQ-7	SOT363	3,000/Tape & Reel

- Notes:
1. No purposely added lead. Fully EU Directive 2002/95/EC (RoHS) & 2011/65/EU (RoHS 2) compliant.
  2. See [http://www.diodes.com/quality/lead\\_free.html](http://www.diodes.com/quality/lead_free.html) for more information about Diodes Incorporated's definitions of Halogen- and Antimony-free, "Green" and Lead-free.
  3. Halogen- and Antimony-free "Green" products are defined as those which contain <900ppm bromine, <900ppm chlorine (<1500ppm total Br + Cl) and <1000ppm antimony compounds.
  4. Automotive products are AEC-Q101 qualified and are PPAP capable. Automotive, AEC-Q101 and standard products are electrically and thermally the same, except where specified. For more information, please refer to [http://www.diodes.com/quality/product\\_grade\\_definitions/](http://www.diodes.com/quality/product_grade_definitions/).
  5. For packaging details, go to our website at <http://www.diodes.com/products/packages.html>.

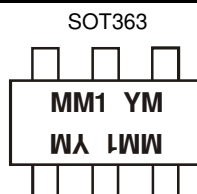
**Marking Information**

MM1= Product Type Marking Code  
 YM = Date Code Marking  
 Y = Year (ex: A = 2013)  
 M = Month (ex: 9 = September)

## Date Code Key

Year	2007	2008	2009	2010	2011	2012	2013	2014	2015	2016	2017	2018
Code	U	V	W	X	Y	Z	A	B	C	D	E	F
Month	Jan	Feb	Mar	Apr	May	Jun	Jul	Aug	Sep	Oct	Nov	Dec
Code	1	2	3	4	5	6	7	8	9	O	N	D

**Maximum Ratings** (@ $T_A = +25^\circ\text{C}$ , unless otherwise specified.)

Characteristic				Symbol	Value	Units
Drain-Source Voltage				$V_{DSS}$	60	V
Gate-Source Voltage				$V_{GSS}$	$\pm 20$	V
Continuous Drain Current (Note 6)	$V_{GS} = 10\text{V}$	Steady State	$T_A = +25^\circ\text{C}$	$I_D$	180	mA
			$T_A = +70^\circ\text{C}$		140	
Continuous Drain Current (Note 6)	$V_{GS} = 5\text{V}$	Steady State	$T_A = +25^\circ\text{C}$	$I_D$	150	mA
			$T_A = +70^\circ\text{C}$		120	
Continuous Drain Current (Note 7)	$V_{GS} = 10\text{V}$	Steady State	$T_A = +25^\circ\text{C}$	$I_D$	200	mA
			$T_A = +70^\circ\text{C}$		160	
Continuous Drain Current (Note 7)	$V_{GS} = 5\text{V}$	Steady State	$T_A = +25^\circ\text{C}$	$I_D$	170	mA
			$T_A = +70^\circ\text{C}$		140	
Pulsed Drain Current (10 $\mu\text{s}$ pulse, duty cycle = 1%)				$I_{DM}$	800	mA

**Thermal Characteristics**

Characteristic	Symbol	Value	Units
Total Power Dissipation (Note 6)	$P_D$	300	mW
Thermal Resistance, Junction to Ambient (Note 6)	$R_{\theta JA}$	435	$^\circ\text{C/W}$
Total Power Dissipation (Note 7)	$P_D$	400	mW
Thermal Resistance, Junction to Ambient (Note 7)	$R_{\theta JA}$	330	$^\circ\text{C/W}$
Thermal Resistance, Junction to Case (Note 7)	$R_{\theta JC}$	139	$^\circ\text{C/W}$
Operating and Storage Temperature Range	$T_J, T_{STG}$	-55 to +150	$^\circ\text{C}$

**Electrical Characteristics** (@ $T_A = +25^\circ\text{C}$ , unless otherwise specified.)

Characteristic	Symbol	Min	Typ	Max	Unit	Test Condition
<b>OFF CHARACTERISTICS (Note 8)</b>						
Drain-Source Breakdown Voltage	$BV_{DSS}$	60	—	—	V	$V_{GS} = 0\text{V}, I_D = 250\mu\text{A}$
Zero Gate Voltage Drain Current	$I_{DSS}$	—	—	1.0	$\mu\text{A}$	$V_{DS} = 60\text{V}, V_{GS} = 0\text{V}$
				5.0		
Gate-Body Leakage	$I_{GSS}$	—	—	$\pm 5.0$	$\mu\text{A}$	$V_{GS} = \pm 20\text{V}, V_{DS} = 0\text{V}$
<b>ON CHARACTERISTICS (Note 8)</b>						
Gate Threshold Voltage	$V_{GS(th)}$	1.0	—	2.0	V	$V_{DS} = V_{GS}, I_D = 250\mu\text{A}$
Static Drain-Source On-Resistance	$R_{DS(on)}$	—	—	8	$\Omega$	$V_{GS} = 5.0\text{V}, I_D = 0.115\text{A}$
		—	—	6	$\Omega$	$V_{GS} = 10.0\text{V}, I_D = 0.115\text{A}$
Forward Transconductance	$g_{FS}$	80	—	—	mS	$V_{DS} = 10\text{V}, I_D = 0.115\text{A}$
Diode Forward Voltage	$V_{SD}$	—	0.8	1.2	V	$V_{GS} = 0\text{V}, I_S = 115\text{mA}$
<b>DYNAMIC CHARACTERISTICS (Note 9)</b>						
Input Capacitance	$C_{iss}$	—	22.0	—	pF	$V_{DS} = 25\text{V}, V_{GS} = 0\text{V}, f = 1.0\text{MHz}$
Output Capacitance	$C_{oss}$	—	3.2	—		
Reverse Transfer Capacitance	$C_{rss}$	—	2.0	—		
Gate Resistance	$R_G$	—	79.9	—	$\Omega$	$V_{DS} = 0\text{V}, V_{GS} = 0\text{V}, f = 1.0\text{MHz}$
Total Gate Charge $V_{GS} = 10\text{V}$	$Q_g$	—	0.87	—	nC	$V_{GS} = 10\text{V}, V_{DS} = 30\text{V}, I_D = 150\text{mA}$
Total Gate Charge $V_{GS} = 4.5\text{V}$	$Q_g$	—	0.43	—		
Gate-Source Charge	$Q_{gs}$	—	0.11	—		
Gate-Drain Charge	$Q_{gd}$	—	0.11	—		
Turn-On Delay Time	$t_{D(on)}$	—	3.3	—	nS	$V_{DD} = 30\text{V}, I_D = 0.115\text{A}, V_{GEN} = 10\text{V}, R_{GEN} = 25\Omega$
Turn-On Rise Time	$t_r$	—	3.2	—		
Turn-Off Delay Time	$t_{D(off)}$	—	12.0	—		
Turn-Off Fall Time	$t_f$	—	6.3	—		

- Notes:
- Device mounted on FR-4 PC board, with minimum recommended pad layout, single sided.
  - Device mounted on FR-4 substrate PC board, 2oz copper, with 1-inch square copper pad layout
  - Short duration pulse test used to minimize self-heating effect.
  - Guaranteed by design. Not subject to production testing.

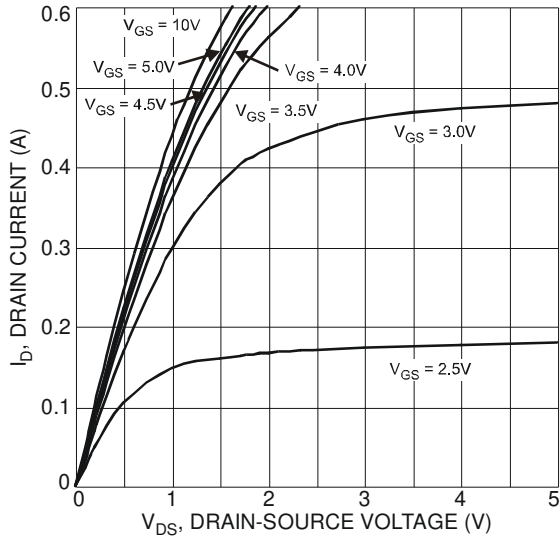

Fig.1 Typical Output Characteristic

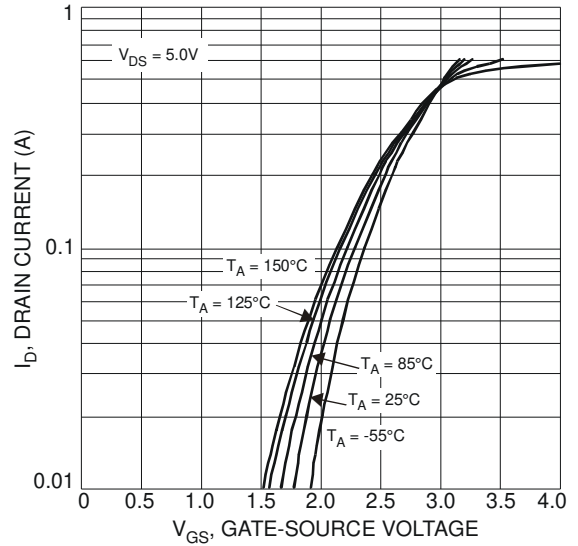

Fig.2 Typical Transfer Characteristics

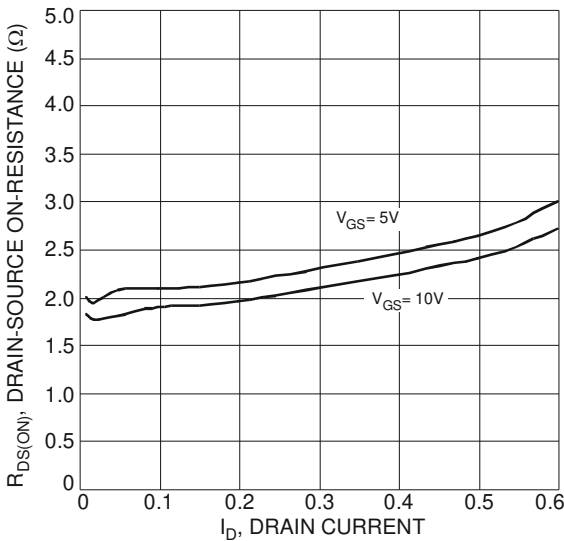

Fig. 3 Typical On-Resistance vs. Drain Current and Temperature

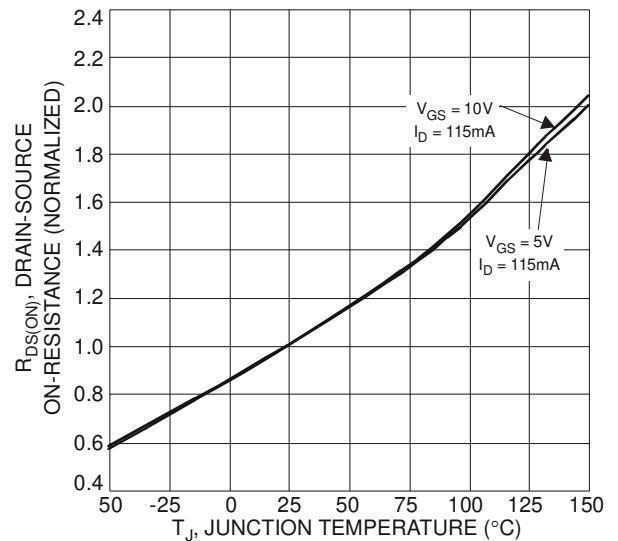

Fig. 4 On-Resistance Variation with Temperature

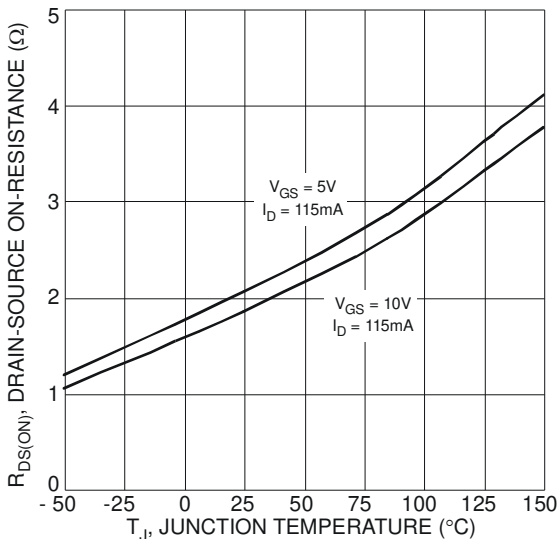

Fig. 5 On-Resistance Variation with Temperature

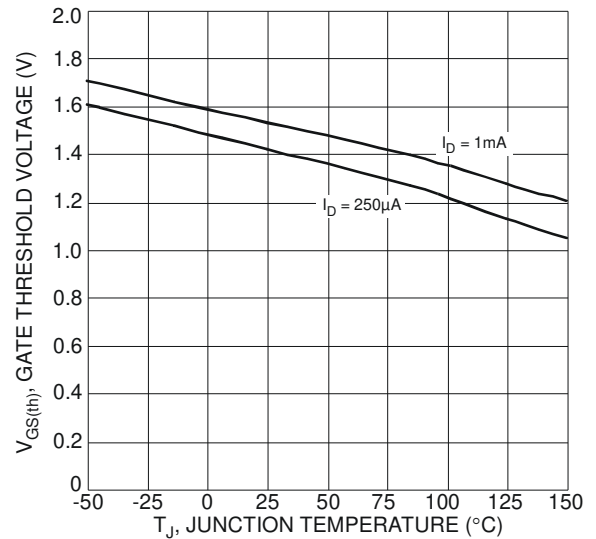

Fig. 6 Gate Threshold Variation vs. Ambient Temperature

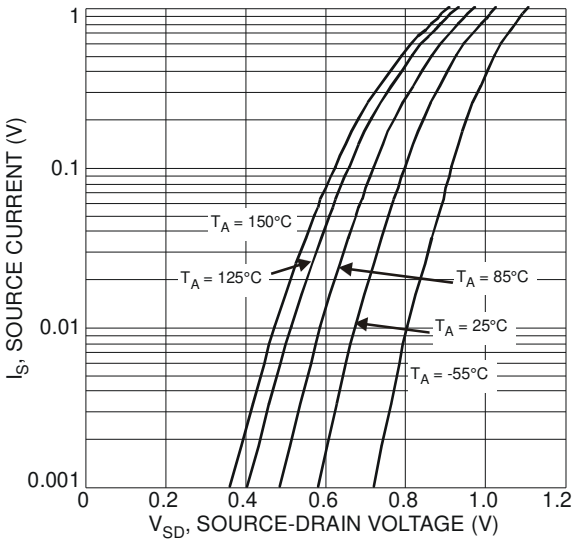

Fig. 7 Diode Forward Voltage vs. Current

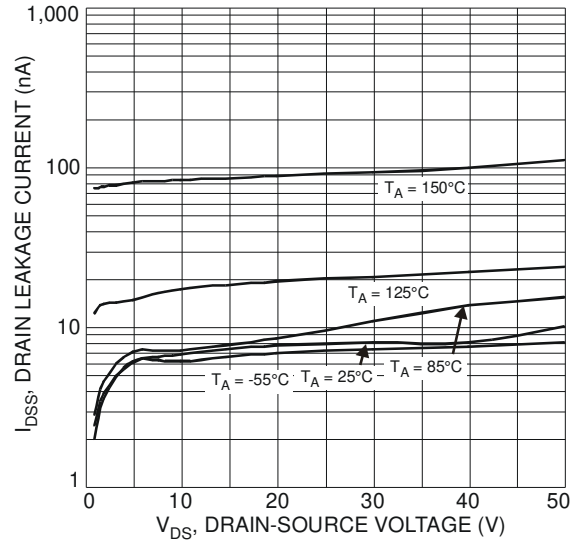

Fig. 8 Typical Drain-Source Leakage Current vs. Voltage

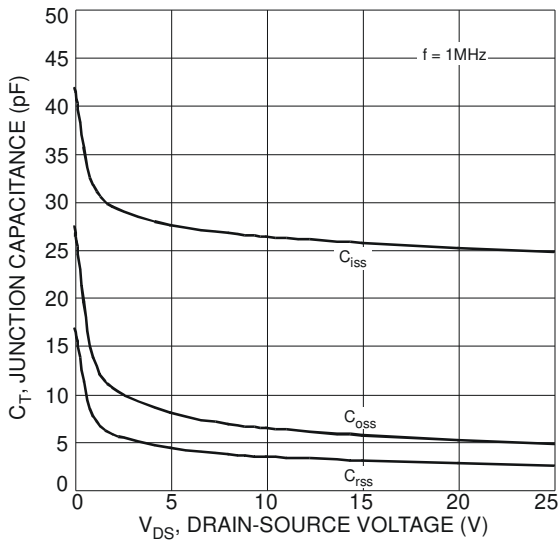

Fig. 9 Typical Junction Capacitance

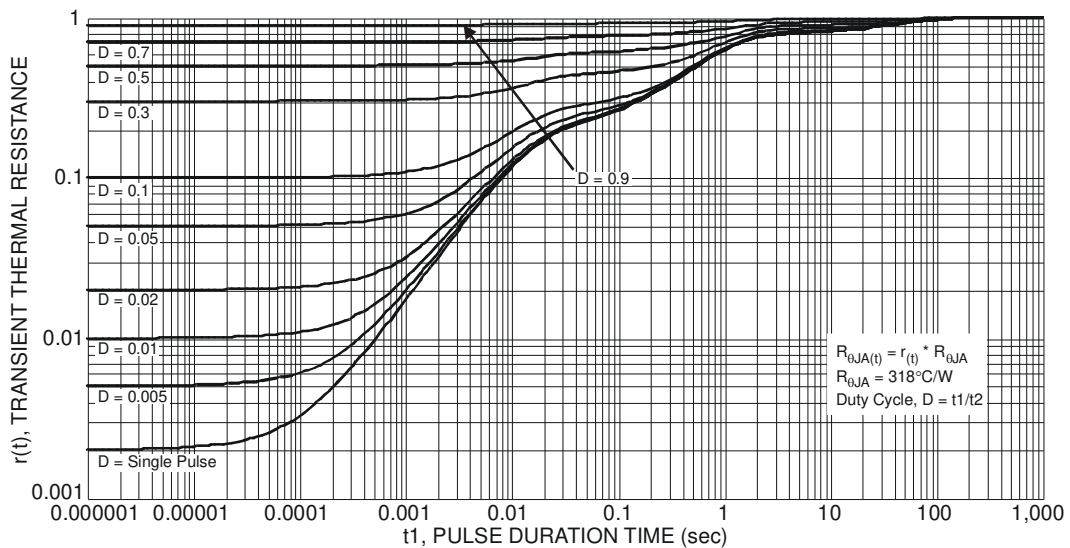

Fig. 10 Transient Thermal Resistance

$$R_{\theta JA(t)} = r(t) * R_{\theta JA}$$

$$R_{\theta JA} = 318^{\circ}\text{C/W}$$

$$\text{Duty Cycle, } D = t1/t2$$

**Package Outline Dimensions**

Please see AP02002 at <http://www.diodes.com/datasheets/ap02002.pdf> for the latest version.

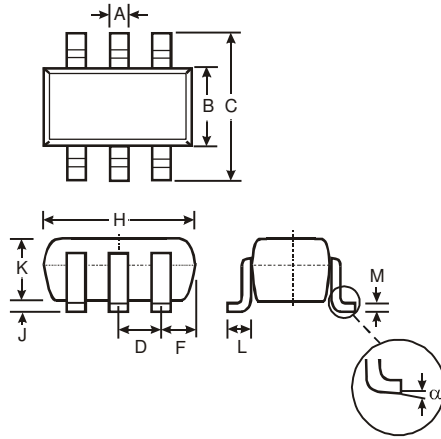

SOT363			
Dim	Min	Max	Typ
A	0.10	0.30	0.25
B	1.15	1.35	1.30
C	2.00	2.20	2.10
D	0.65 Typ		
F	0.40	0.45	0.425
H	1.80	2.20	2.15
J	0	0.10	0.05
K	0.90	1.00	1.00
L	0.25	0.40	0.30
M	0.10	0.22	0.11
α	0°	8°	-
<b>All Dimensions in mm</b>			

**Suggested Pad Layout**

Please see AP02001 at <http://www.diodes.com/datasheets/ap02001.pdf> for the latest version.

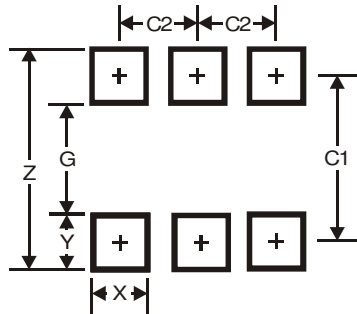

Dimensions	Value (in mm)
Z	2.5
G	1.3
X	0.42
Y	0.6
C1	1.9
C2	0.65

**IMPORTANT NOTICE**

DIODES INCORPORATED MAKES NO WARRANTY OF ANY KIND, EXPRESS OR IMPLIED, WITH REGARDS TO THIS DOCUMENT, INCLUDING, BUT NOT LIMITED TO, THE IMPLIED WARRANTIES OF MERCHANTABILITY AND FITNESS FOR A PARTICULAR PURPOSE (AND THEIR EQUIVALENTS UNDER THE LAWS OF ANY JURISDICTION).

Diodes Incorporated and its subsidiaries reserve the right to make modifications, enhancements, improvements, corrections or other changes without further notice to this document and any product described herein. Diodes Incorporated does not assume any liability arising out of the application or use of this document or any product described herein; neither does Diodes Incorporated convey any license under its patent or trademark rights, nor the rights of others. Any Customer or user of this document or products described herein in such applications shall assume all risks of such use and will agree to hold Diodes Incorporated and all the companies whose products are represented on Diodes Incorporated website, harmless against all damages.

Diodes Incorporated does not warrant or accept any liability whatsoever in respect of any products purchased through unauthorized sales channel. Should Customers purchase or use Diodes Incorporated products for any unintended or unauthorized application, Customers shall indemnify and hold Diodes Incorporated and its representatives harmless against all claims, damages, expenses, and attorney fees arising out of, directly or indirectly, any claim of personal injury or death associated with such unintended or unauthorized application.

Products described herein may be covered by one or more United States, international or foreign patents pending. Product names and markings noted herein may also be covered by one or more United States, international or foreign trademarks.

This document is written in English but may be translated into multiple languages for reference. Only the English version of this document is the final and determinative format released by Diodes Incorporated.

**LIFE SUPPORT**

Diodes Incorporated products are specifically not authorized for use as critical components in life support devices or systems without the express written approval of the Chief Executive Officer of Diodes Incorporated. As used herein:

A. Life support devices or systems are devices or systems which:

1. are intended to implant into the body, or
2. support or sustain life and whose failure to perform when properly used in accordance with instructions for use provided in the labeling can be reasonably expected to result in significant injury to the user.

B. A critical component is any component in a life support device or system whose failure to perform can be reasonably expected to cause the failure of the life support device or to affect its safety or effectiveness.

Customers represent that they have all necessary expertise in the safety and regulatory ramifications of their life support devices or systems, and acknowledge and agree that they are solely responsible for all legal, regulatory and safety-related requirements concerning their products and any use of Diodes Incorporated products in such safety-critical, life support devices or systems, notwithstanding any devices- or systems-related information or support that may be provided by Diodes Incorporated. Further, Customers must fully indemnify Diodes Incorporated and its representatives against any damages arising out of the use of Diodes Incorporated products in such safety-critical, life support devices or systems.

Copyright © 2015, Diodes Incorporated

**www.diodes.com**