

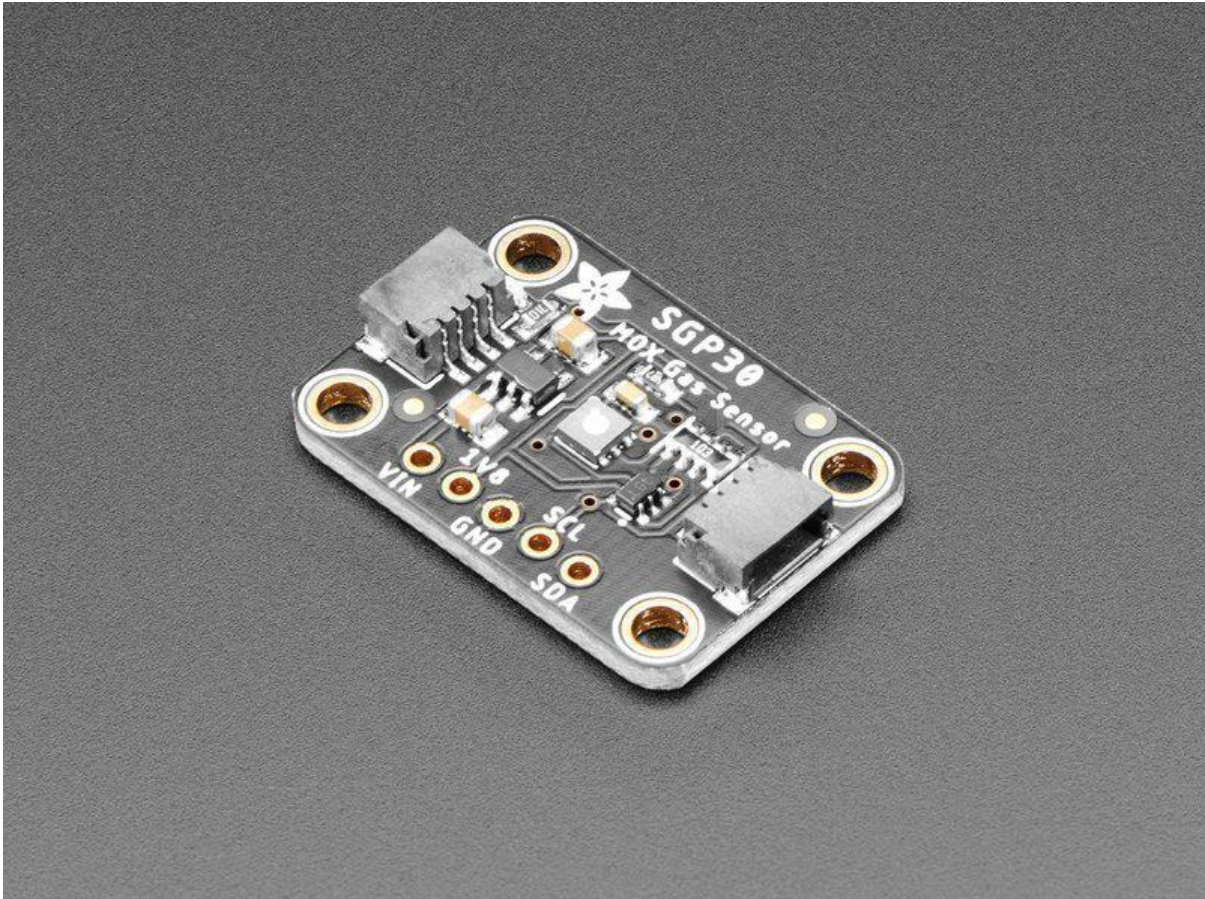

Adafruit SGP30 TVOC/eCO2 Gas Sensor

Created by lady ada



<https://learn.adafruit.com/adafruit-sgp30-gas-tvoc-eco2-mox-sensor>

Last updated on 2022-12-01 03:09:00 PM EST

Table of Contents

Overview	3
Pinouts	6
<ul style="list-style-type: none">• Data Pins• Power Pins:	
Arduino Test	7
<ul style="list-style-type: none">• Wiring• Install Adafruit_SGP30 library• Load Demo• Baseline Set & Get	
Arduino Library Docs	13
Python & CircuitPython Test	13
<ul style="list-style-type: none">• CircuitPython MicroController Wiring• Python Computer Wiring• CircuitPython Installation of SGP30 Library• Python Installation of SGP30 Library• CircuitPython & Python Usage• Baseline Set & Get	
Python Library Docs	20
Download	20
<ul style="list-style-type: none">• Files:• Schematic STEMMA QT Version• Fabrication Print STEMMA QT Version• Schematic & Fabrication Print Original Version	

Overview

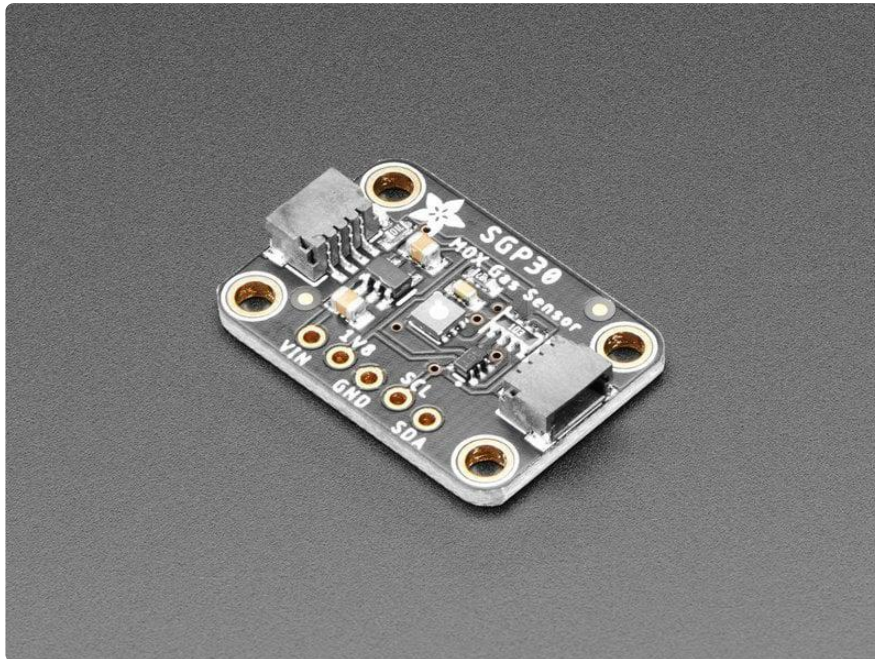

Breathe easy with the SGP30 Multi-Pixel Gas Sensor, a fully integrated MOX gas sensor. This is a very fine air quality sensor from the sensor experts at Sensirion, with I2C interfacing and fully calibrated output signals with a typical accuracy of 15% within measured values. The SGP combines multiple metal-oxide sensing elements on one chip to provide more detailed air quality signals.

This is a gas sensor that can detect a wide range of Volatile Organic Compounds (VOCs) and H₂ and is intended for indoor air quality monitoring. When connected to your microcontroller (running our library code) it will return a Total Volatile Organic Compound (TVOC) reading and an equivalent carbon dioxide reading (eCO₂) over I2C.

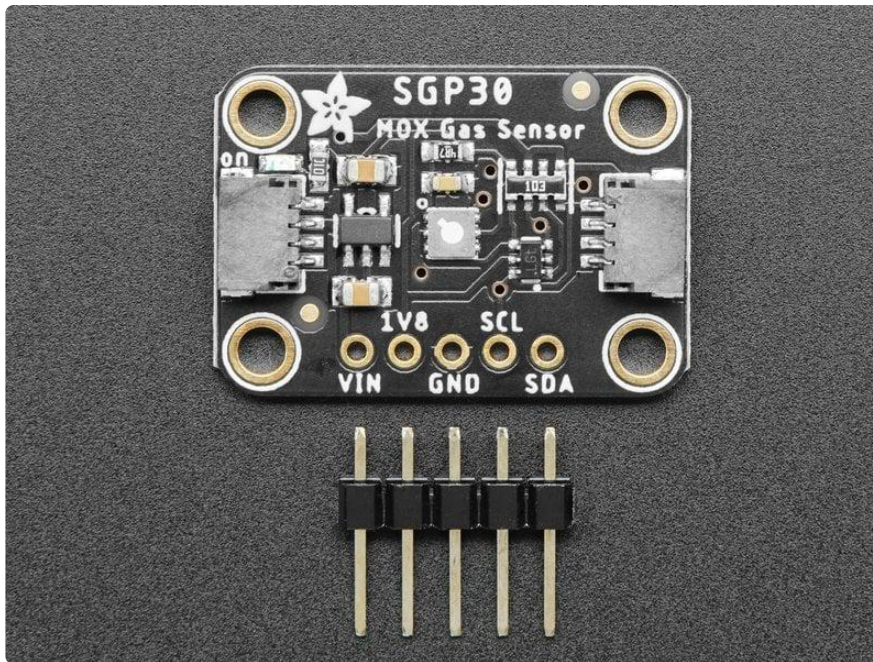

The SGP30 has a 'standard' hot-plate MOX sensor, as well as a small microcontroller that controls power to the plate, reads the analog voltage, tracks the baseline calibration, calculates TVOC and eCO₂ values, and provides an I²C interface to read from. Unlike the CCS811, this sensor does not require I²C clock stretching.

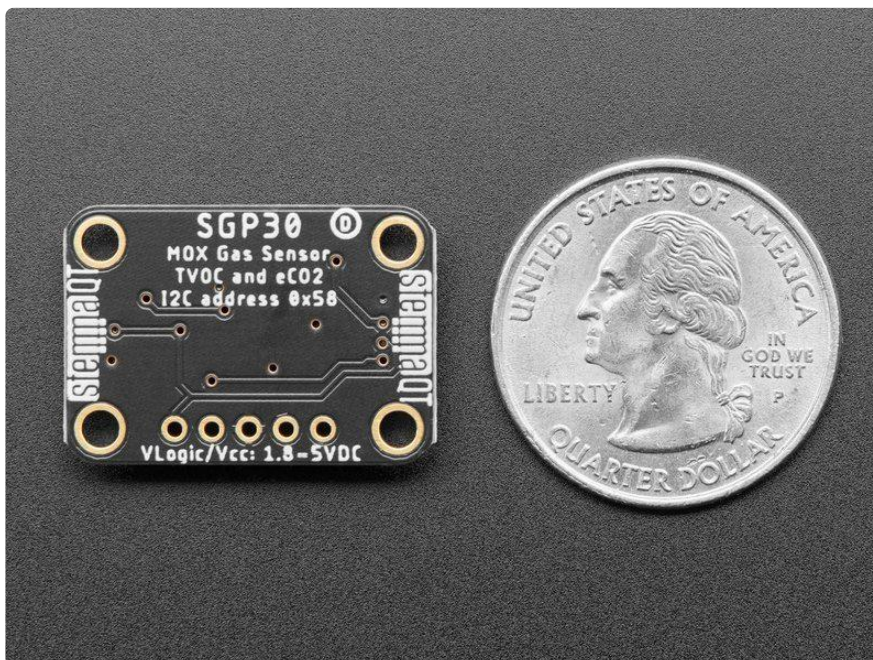

This part will measure eCO₂ (equivalent calculated carbon-dioxide) concentration within a range of 400 to 60,000 parts per million (ppm), and TVOC (Total Volatile Organic Compound) concentration within a range of 0 to 60,000 parts per billion (ppb).

Please note, this sensor, like all VOC/gas sensors, has variability and to get precise measurements you will want to calibrate it against known sources! That said, for general environmental sensors, it will give you a good idea of trends and comparison. The SGP30 does have built in calibration capabilities, note that eCO2 is calculated based on H2 concentration, it is not a 'true' CO2 sensor for laboratory use.

Another nice element to this sensor is the ability to set humidity compensation for better accuracy. An external humidity sensor is required and then the RH% is written over I2C to the sensor, so it can better calculate the TVOC/eCO2 values.

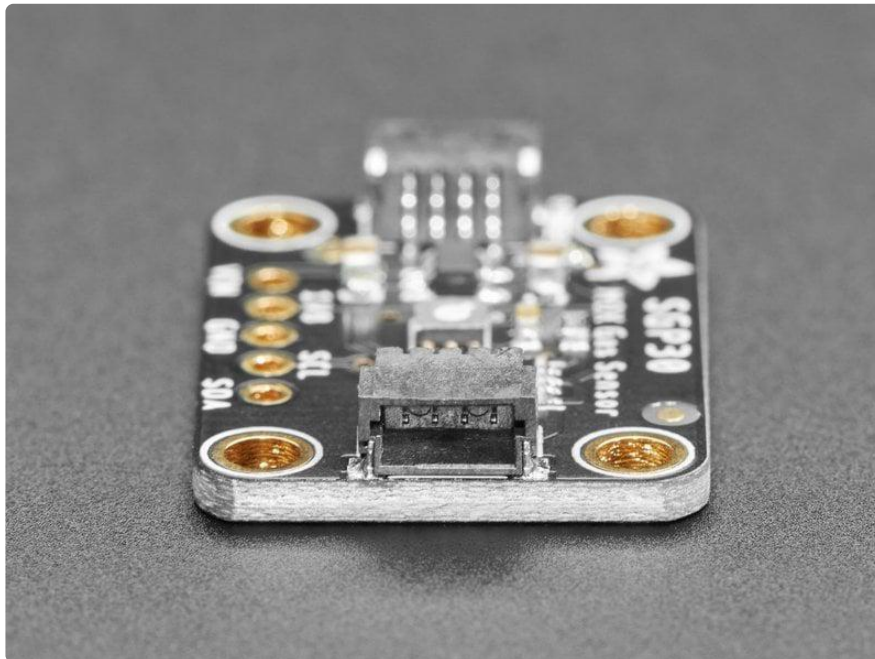

Nice sensor right? So we made it easy for you to get right into your next project. The surface-mount sensor is soldered onto a custom made PCB in the [STEMMA QT form factor](#) (), making them easy to interface with. The [STEMMA QT connectors](#) () on either side are compatible with the [SparkFun Qwiic](#) () I2C connectors. This allows you to make solderless connections between your development board and the SGP30 or to chain it with a wide range of other sensors and accessories using a [compatible cable](#) ().

We've of course broken out all the pins to standard headers and added a 1.8V voltage regulator and level shifting so allow you to use it with either 3.3V or 5V systems such as the Raspberry Pi, or Metro M4 or Arduino Uno.

There are two versions of this board - the STEMMA QT version shown above, and the original header-only version shown below. Code works the same on both!

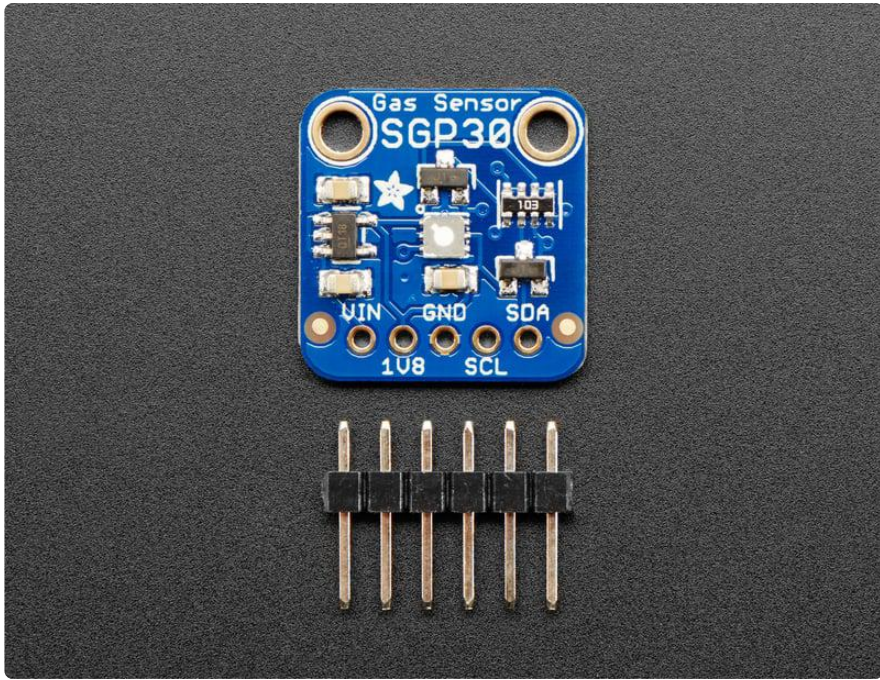

Pinouts

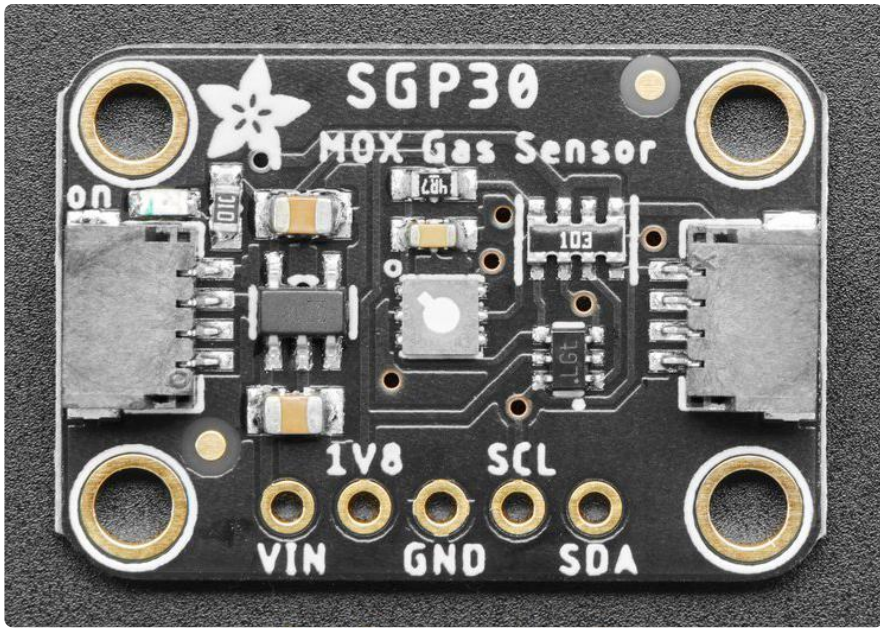



Power Pins:

- Vin - this is the power pin. Since the sensor chip uses 3 VDC for logic, we have included a voltage regulator on board that will take 3-5VDC and safely convert it down. To power the board, give it the same power as the logic level of your microcontroller - e.g. for a 5V micro like Arduino, use 5V
- 1V8 - this is the 1.8V output from the voltage regulator, you can grab up to 50mA from this if you like
- GND - common ground for power and logic

Data Pins

- SCL - I2C clock pin, connect to your microcontrollers I2C clock line. Can use 3V or 5V logic, and has a 10K pullup to Vin
- SDA - I2C data pin, connect to your microcontrollers I2C data line. Can use 3V or 5V logic, and has a 10K pullup to Vin
- [STEMMA QT \(\)](#) - These connectors allow you to connect to dev boards with S TEMMA QT connectors or to other things with [various associated accessories \(\)](#)

Arduino Test

You can easily wire this breakout to any microcontroller; we'll be using an Arduino.

Start by soldering the headers to the SGP30 breakout board. Check out the [Adafruit guide to excellent soldering \(\)](#) if you're new to soldering. Then continue on below to learn how to wire it to a Metro.

The sensor uses I2C address 0x58 and cannot be changed.

Wiring

Connect the SGP30 breakout to your board using an I2C connection. Here's an example with an Arduino-compatible Metro:

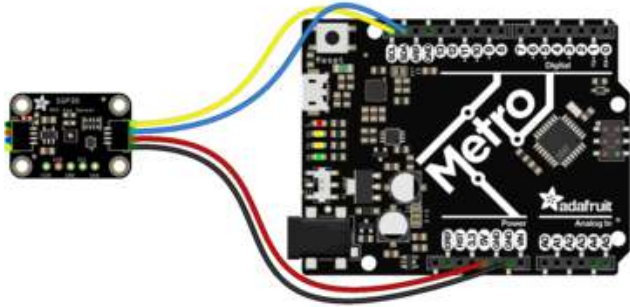

fritzing

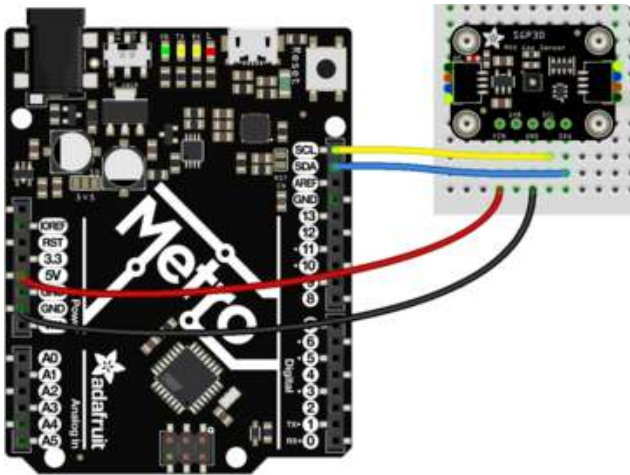

Board 5V to Sensor Vin (red wire on STEMMA QT version). (Metro is a 5V logic chip)

Board ground / GND to sensor ground / GND (black wire on STEMMA QT version).
Board SCL to sensor SCL (yellow wire on STEMMA QT version).

Board SDA to sensor SDA (blue wire on STEMMA QT version).

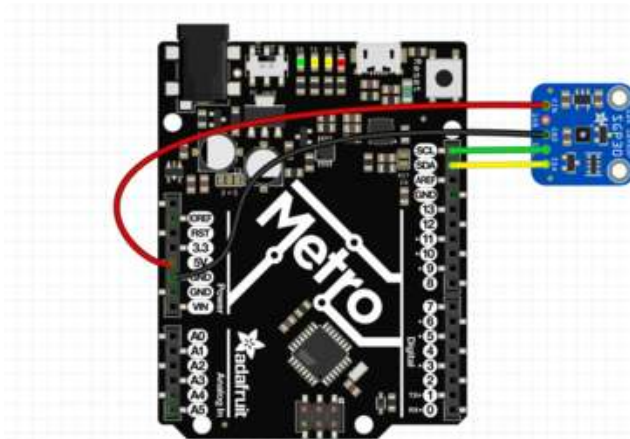

ing

Metro Original Fritzing File

Install Adafruit_SGP30 library

To begin reading sensor data, you will need to [install the Adafruit_SGP30 library \(code on our github repository\) \(\)](#). It is available from the Arduino library manager so we recommend using that.

From the IDE open up the library manager...

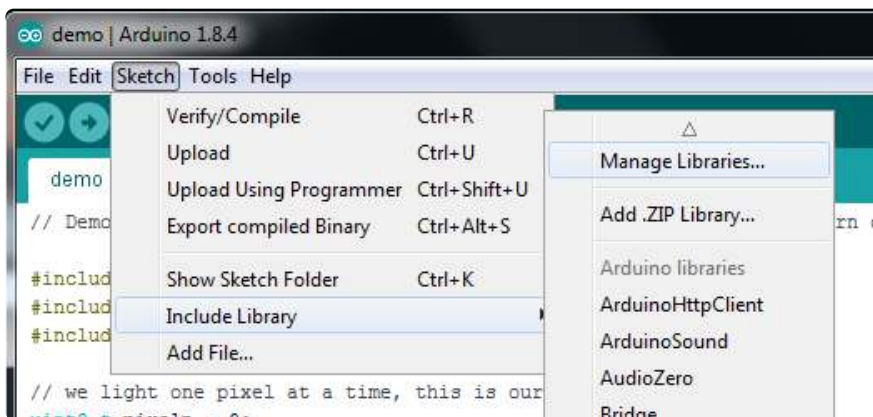

And type in adafruit sgp30 to locate the library. Click Install



Load Demo

Open up File->Examples->Adafruit_SGP30->sgp30test and upload to your microcontroller wired up to the sensor

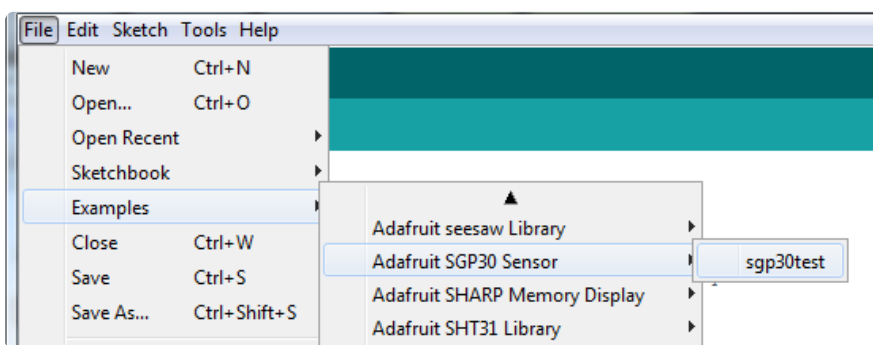

Then open up the serial console at 115200 baud, you'll see the serial number printed out - this is a unique 48-bit number burned into each chip. Since you may want to do per-chip calibration, this can help keep your calibration detail separate

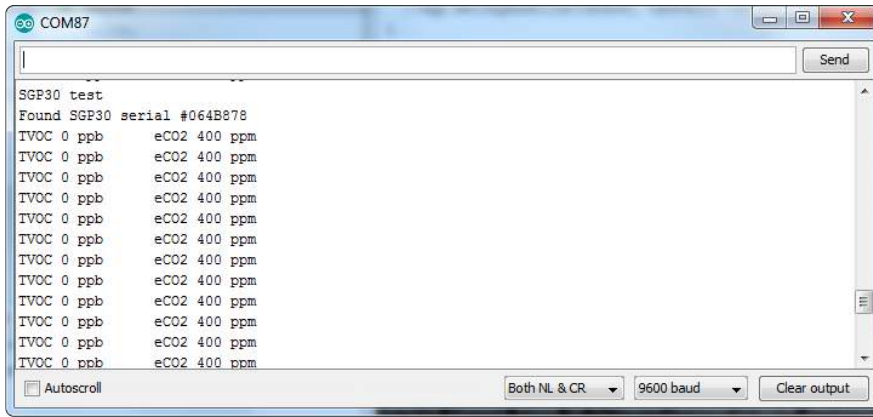

The first 10-20 readings will always be **TVOC 0 ppb eCO2 400 ppm**. That's because the sensor is warming up, so it will have 'null' readings.

After a few seconds, you will see the TVOC and eCO2 readings fluctuate:

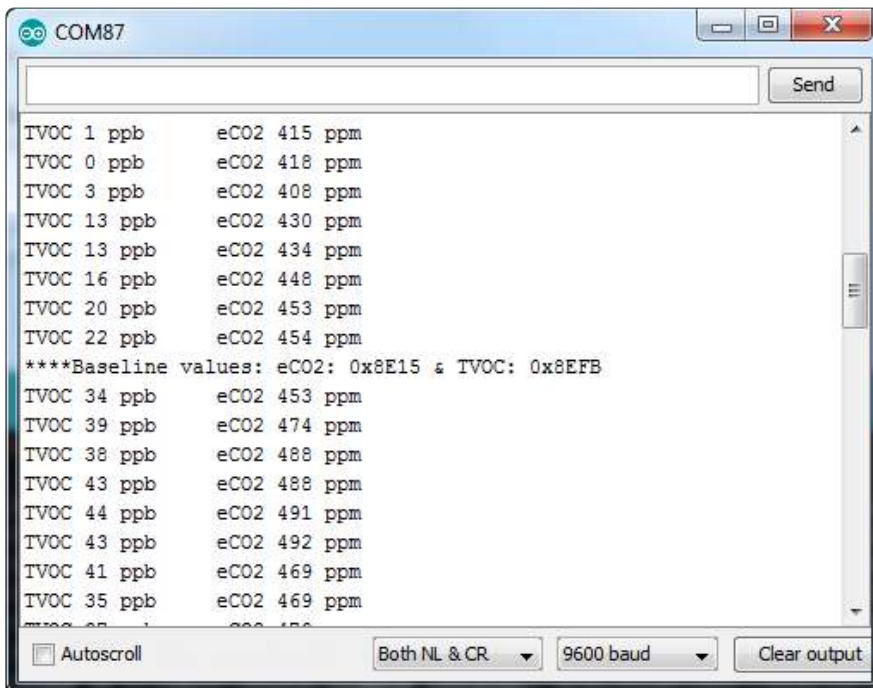

Every minute or so you'll also get a Baseline value printed out. More about that later!

You can take a bit of alcohol on a swab and swipe it nearby to get the readings to spike

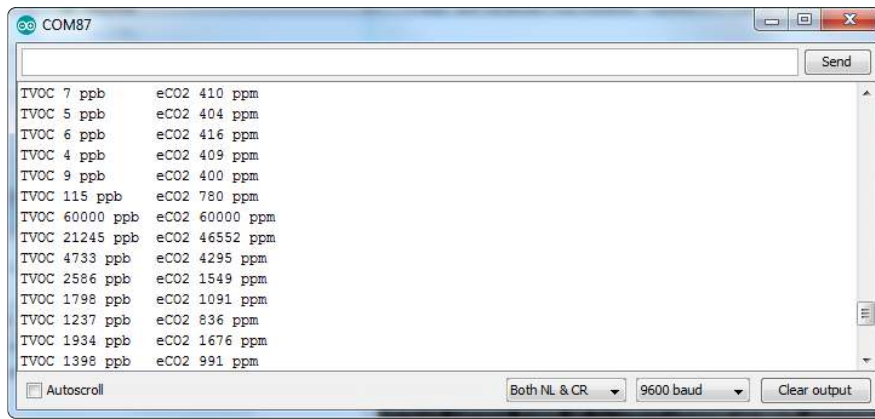

That's it! The sensor pretty much only does that - all the calculations for the TVOC and eCO2 are done within the sensor itself, no other data is exposed beyond the 'baseline' values

Baseline Set & Get

All VOC/gas sensors use the same underlying technology: a tin oxide element that, when exposed to organic compounds, changes resistance. The 'problem' with these sensors is that the baseline changes, often with humidity, temperature, and other non-gas-related-events. To keep the values coming out reasonable, you'll need to calibrate the sensor.

If no stored baseline is available after initializing the baseline algorithm, the sensor has to run for 12 hours until the baseline can be stored. This will ensure an optimal behavior for the next time it starts up. Reading out the baseline prior should be avoided unless a valid baseline is restored first. Once the baseline is properly initialized or restored, the current baseline value should be stored approximately once per hour. While the sensor is off, baseline values are valid for a maximum of seven days.

Restarting the sensor without reading back a previously stored baseline will result in the sensor trying to determine a new baseline. The adjustment algorithm will be accelerated for 12hrs which is the Maximum time required to find a new baseline.

The sensor adjusts to the best value it has been exposed to. So keeping it indoors the sensor thinks this is the best value and sets it to ~0ppb tVOC and 400ppm CO2eq. As soon as you expose the sensor to outside air it can adjust to the global H2 Background Signal. For normal Operation exposing the sensor to outside air for 10min cumulative time should be sufficient.

If you're experienced with sensors that don't have a baseline, you either won't be able to measure absolute values or you'll have to implement your own baseline algorithm.

The sensor to sensor variation of SGP30 in terms of sensitivity is very good as each of them is calibrated. But the baseline has to be determined for each sensor individually during the first Operation.

To make that easy, SGP lets you query the 'baseline calibration readings' from the sensor with code like this:

```
uint16_t TVOC_base, eCO2_base;
sgp.getIAQBaseline(&eCO2_base, &TVOC_base);
```

This will grab the two 16-bit sensor calibration words and place them in the variables so-named.

You should store these in EEPROM, FLASH or hard-coded. Then, next time you start up the sensor, you can pre-fill the calibration words with

```
sgp.setIAQBaseline(eCO2_baseline, TVOC_baseline);
```

Arduino Library Docs

[Arduino Library Docs \(\)](#)

Python & CircuitPython Test

It's easy to use the SGP30 sensor with Python or CircuitPython and the [Adafruit CircuitPython SGP30 \(\)](#) module. This module allows you to easily write Python code that reads the TVOC, eCO2, and more from the sensor.

You can use this sensor with any CircuitPython microcontroller board or with a computer that has GPIO and Python [thanks to Adafruit_Blinka, our CircuitPython-for-Python compatibility library \(\)](#).

CircuitPython MicroController Wiring

Connect the SGP30 breakout to your board using an I2C connection, exactly as shown on the previous page for Arduino. Here's an example with a Feather M0:

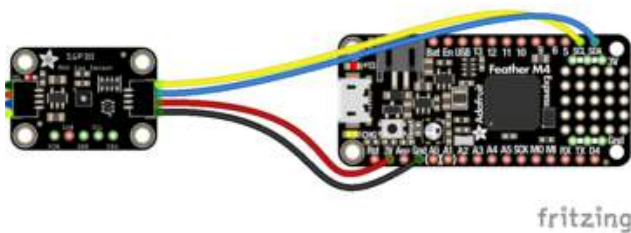

fritzing

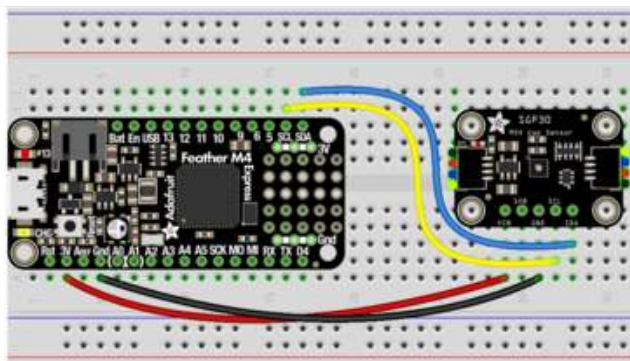

Board 3.3V to sensor Vin (red wire on STEMMA QT version) (Feather is 3.3V logic)

Board ground / GND to sensor ground / GND (black wire on STEMMA QT version).
Board SCL to sensor SCL (yellow wire on STEMMA QT version).

Board SDA to sensor SDA (blue wire on STEMMA QT version).

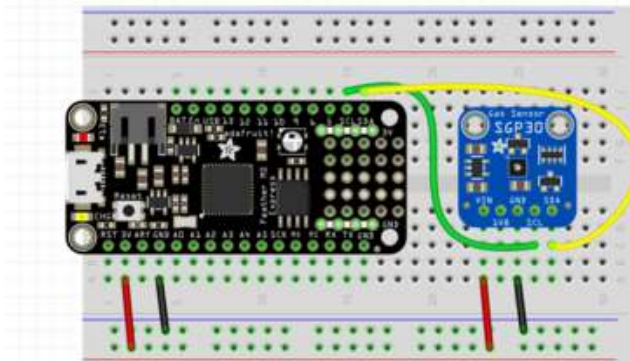

Feather Original Fritzing file

Python Computer Wiring

Since there's dozens of Linux computers/boards you can use we will show wiring for Raspberry Pi. For other platforms, [please visit the guide for CircuitPython on Linux to see whether your platform is supported \(\)](#).

Here's the Raspberry Pi wired with I2C:

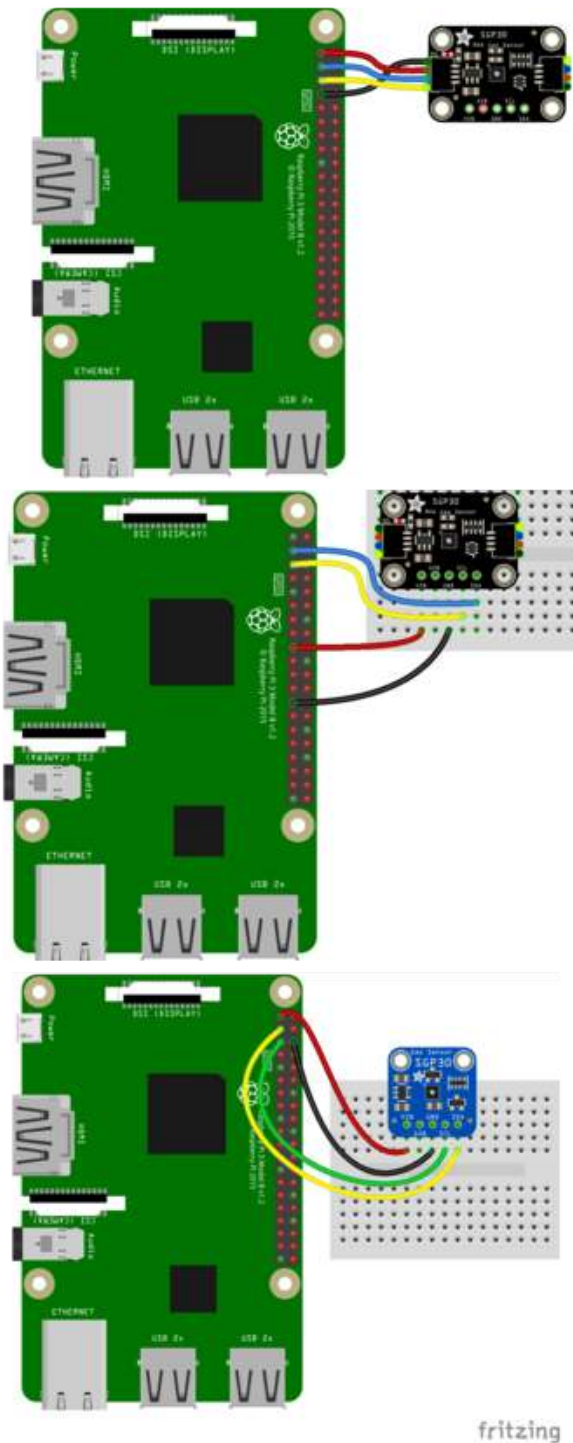

Pi 3V3 to sensor VIN (red wire on STEMMA QT version)

Pi GND to sensor GND (black wire on STEMMA QT version)

Pi SCL to sensor SCL (yellow wire on STEMMA QT version)

Pi SDA to sensor SDA (blue wire on STEMMA QT version)

CircuitPython Installation of SGP30 Library

To use the SGP30 you'll need to install the [Adafruit CircuitPython SGP30 \(\)](#) library on your CircuitPython board.

First make sure you are running the [latest version of Adafruit CircuitPython \(\)](#) for your board.

Next you'll need to install the necessary libraries to use the hardware--carefully follow the steps to find and install these libraries from [Adafruit's CircuitPython library bundle \(\)](#). Our introduction guide has [a great page on how to install the library bundle \(\)](#) for both express and non-express boards.

Remember for non-express boards like the, you'll need to manually install the necessary libraries from the bundle:

- adafruit_sgp30.mpy
- adafruit_bus_device

You can also download the adafruit_sgp.mpy from [its releases page on Github \(\)](#).

Before continuing make sure your board's lib folder or root filesystem has the adafruit_sgp30.mpy, and adafruit_bus_device files and folders copied over.

Next [connect to the board's serial REPL \(\)](#) so you are at the CircuitPython >>> prompt.

Python Installation of SGP30 Library

You'll need to install the Adafruit_Blinka library that provides the CircuitPython support in Python. This may also require enabling I2C on your platform and verifying you are running Python 3. [Since each platform is a little different, and Linux changes often, please visit the CircuitPython on Linux guide to get your computer ready \(\)!](#)

Once that's done, from your command line run the following command:

- `sudo pip3 install adafruit-circuitpython-sgp30`

If your default Python is version 3 you may need to run 'pip' instead. Just make sure you aren't trying to use CircuitPython on Python 2.x, it isn't supported!

CircuitPython & Python Usage

To demonstrate the usage of the sensor we'll initialize it and read the eCO2 and TVOC data and print it to the REPL

Save this example sketch as main.py on your CircuitPython board:

```
# SPDX-FileCopyrightText: 2021 ladyada for Adafruit Industries
# SPDX-License-Identifier: MIT

""" Example for using the SGP30 with CircuitPython and the Adafruit library"""

import time
import board
import busio
import adafruit_sgp30

i2c = busio.I2C(board.SCL, board.SDA, frequency=100000)

# Create library object on our I2C port
sgp30 = adafruit_sgp30.Adafruit_SGP30(i2c)

print("SGP30 serial #", [hex(i) for i in sgp30.serial])

sgp30.set_iaq_baseline(0x8973, 0x8AAE)
sgp30.set_iaq_relative_humidity(celsius=22.1, relative_humidity=44)

elapsed_sec = 0

while True:
    print("eCO2 = %d ppm \t TVOC = %d ppb" % (sgp30.eCO2, sgp30.TVOC))
    time.sleep(1)
    elapsed_sec += 1
    if elapsed_sec > 10:
        elapsed_sec = 0
        print(
            "**** Baseline values: eCO2 = 0x%x, TVOC = 0x%x"
            % (sgp30.baseline_eCO2, sgp30.baseline_TVOC)
        )
```

In the REPL you'll see the serial number printed out: `[0x0, 0x64, 0xb878]` in this case. This is a unique 48-bit number burned into each chip. Since you may want to do per-chip calibration, this can help keep your calibration detail separate

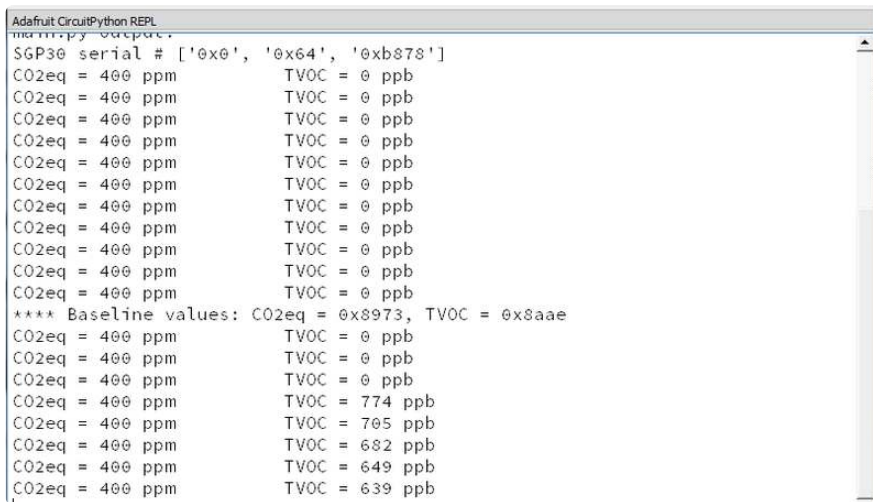
A screenshot of the Adafruit CircuitPython REPL window. The window title is "Adafruit CircuitPython REPL". The output shows a series of sensor readings: "SGP30 serial # ['\x00', '\x64', '\xb878']", followed by multiple lines of "CO2eq = 400 ppm" and "TVOC = 0 ppb". A "Baseline values" section is also visible, showing "CO2eq = 0x8973, TVOC = 0x8aae". The output continues with more "CO2eq" and "TVOC" readings, including some higher values like "TVOC = 774 ppb", "TVOC = 705 ppb", "TVOC = 682 ppb", "TVOC = 649 ppb", and "TVOC = 639 ppb".

The first 10-20 readings will always be **eCO2 400 ppm TVOC 0 ppb** . That's because the sensor is warming up, so it will have 'null' readings.

After a few seconds, you will see the TVOC and eCO2 readings fluctuate

Every minute or so you'll also get a Baseline value printed out. More about that later!

You can take a bit of alcohol on a swab and swipe it nearby to get the readings to spike

```
CO2eq = 400 ppm            TVOC = 0 ppb
CO2eq = 400 ppm            TVOC = 0 ppb
CO2eq = 400 ppm            TVOC = 0 ppb
CO2eq = 400 ppm            TVOC = 0 ppb
**** Baseline values: CO2eq = 0x8973, TVOC = 0x8ab2
CO2eq = 400 ppm            TVOC = 0 ppb
CO2eq = 60000 ppm          TVOC = 60000 ppb
CO2eq = 38277 ppm          TVOC = 13302 ppb
CO2eq = 3208 ppm           TVOC = 3078 ppb
CO2eq = 994 ppm            TVOC = 1638 ppb
CO2eq = 415 ppm            TVOC = 799 ppb
CO2eq = 400 ppm            TVOC = 663 ppb
CO2eq = 400 ppm            TVOC = 666 ppb
```

That's it! The sensor pretty much only does that - all the calculations for the TVOC and eCO2 are done within the sensor itself, no other data is exposed beyond the 'baseline' values

Baseline Set & Get

All VOC/gas sensors use the same underlying technology: a tin oxide element that, when exposed to organic compounds, changes resistance. The 'problem' with these sensors is that the baseline changes, often with humidity, temperature, and other non-

gas-related-events. To keep the values coming out reasonable, you'll need to calibrate the sensor.

If no stored baseline is available after initializing the baseline algorithm, the sensor has to run for 12 hours until the baseline can be stored. This will ensure an optimal behavior for preceding startups. Reading out the baseline prior should be avoided unless a valid baseline is restored first. Once the baseline is properly initialized or restored, the current baseline value should be stored approximately once per hour. While the sensor is off, baseline values are valid for a maximum of seven days.

Restarting the sensor without reading back a previously stored baseline will result in the sensor trying to determine a new baseline. The adjustment algorithm will be accelerated for 12hrs which is the Maximum time required to find a new baseline.

The sensor adjusts to the best value it has been exposed to. So keeping it indoors the sensor thinks this is the best value and sets it to ~0ppb tVOC and 400ppm CO₂eq. As soon as you expose the sensor to outside air it can adjust to the global H₂ Background Signal. For normal Operation exposing the sensor to outside air for 10min cumulative time should be sufficient.

If you're experienced with sensors that don't have a baseline, you either won't be able to measure absolute values or you'll have to implement your own baseline algorithm.

The sensor to sensor variation of SGP30 in terms of sensitivity is very good as each of them is calibrated. But the baseline has to be determined for each sensor individually during the first Operation.

To make that easy, SGP lets you query the 'baseline calibration readings' from the sensor with code like this:

```
co2eq_base, tvoc_base = sgp30.baseline_co2eq, sgp30.baseline_tvoc
```

This will grab the two 16-bit sensor calibration words and place them in the variables so-named.

You should store these in EEPROM, FLASH or hard-coded. Then, next time you start up the sensor, you can pre-fill the calibration words with `sgp30.set_iaq_baseline(co2eq_base, tvoc_base)`

Python Library Docs

[Python Library Docs \(\)](#)

Download

Files:

- [SGP30 Datasheet \(\)](#)
- [Fritzing object in Adafruit Fritzing library \(\)](#)
- [EagleCAD files on GitHub \(\)](#)

Schematic STEMMA QT Version

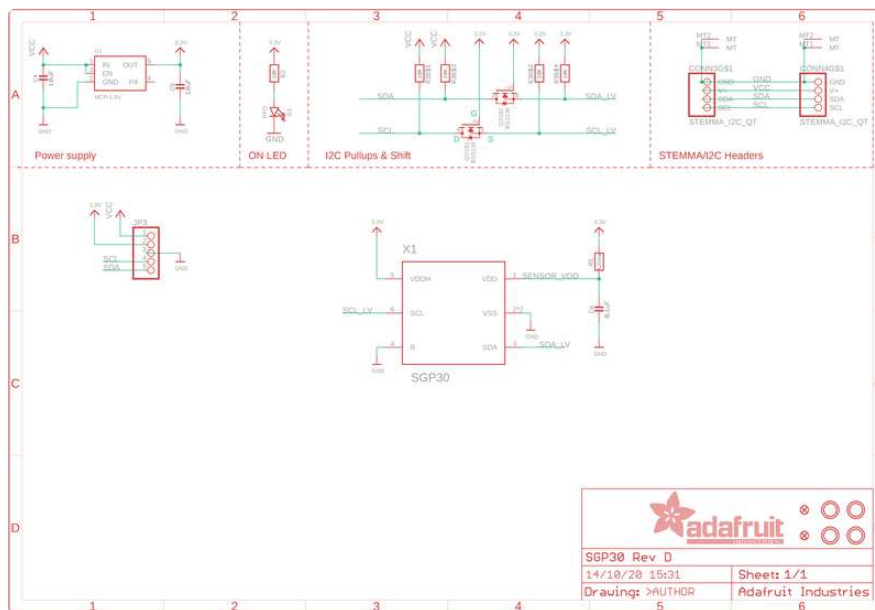

Fabrication Print STEMMMA QT Version

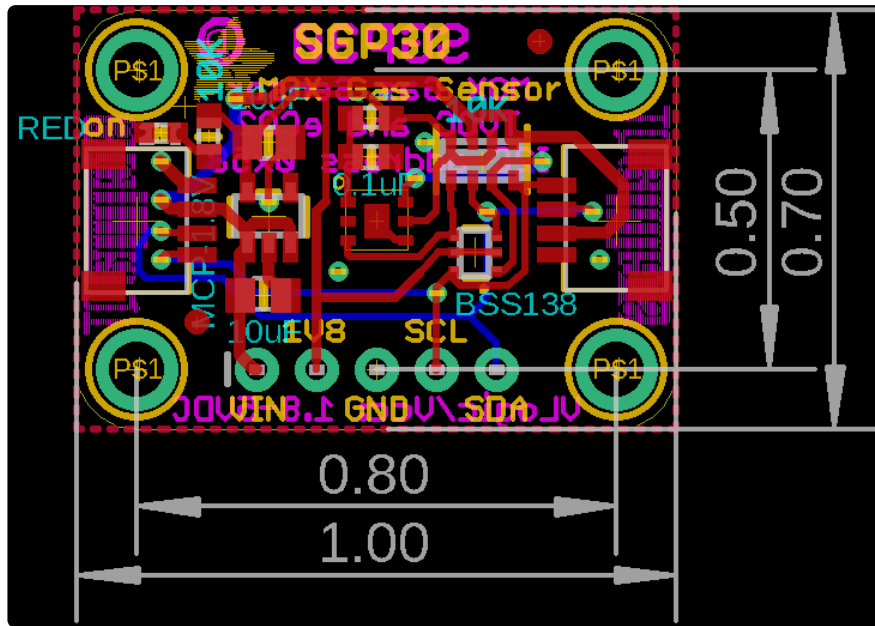

Schematic & Fabrication Print Original Version

